

# CURRENT RESEARCH IN ENGINEERING

JUNE 2022

## EDITORS

ASSOC. PROF. DR. SELAHATTIN BARDAK

ASSIST. PROF. DR. NUMAN YALÇIN

DR. ÖMER YURDAKUL

**İmtiyaz Sahibi / Publisher • Yaşar Hız**  
**Genel Yayın Yönetmeni / Editor in Chief • Eda Altunel**  
**Kapak & İç Tasarım / Cover & Interior Design • Gece Kitaplığı**  
**Editörler / Editors • Assoc. Prof. Dr. Selahattin BARDAK**  
Assist. Prof. Dr. Numan YALÇIN  
Dr. Ömer YURDAKUL  
**Birinci Basım / First Edition • © Haziran 2022**  
**ISBN • 978-625-430-136-0**

**© copyright**

Bu kitabın yayın hakkı Gece Kitaplığı'na aittir.

Kaynak gösterilmeden alıntı yapılamaz, izin  
almadan hiçbir yolla çoğaltılamaz.

The right to publish this book belongs to Gece Kitaplığı.  
Citation can not be shown without the source, reproduced in any way  
without permission.

**Gece Kitaplığı / Gece Publishing**  
**Türkiye Adres / Turkey Address:** Kızılay Mah. Fevzi Çakmak 1. Sokak  
Ümit Apt. No: 22/A Çankaya / Ankara / TR  
**Telefon / Phone:** +90 312 384 80 40  
**web:** www.gecekitapligi.com  
**e-mail:** gecekitapligi@gmail.com



**Baskı & Cilt / Printing & Volume**

Sertifika / Certificate No: 47083

# Current Research in Engineering

June 2022

## Editors

Assoc. Prof. Dr. Selahattin BARDAK

Assist. Prof. Dr. Numan YALÇIN

Dr. Ömer YURDAKUL





# CONTENTS

## **CHAPTER 1**

INFLUENCE OF ALGINATE POLYMER AND LIQUID SILICATE DERIVATIVES ADDITION ON FUNDAMENTAL CHARACTERISTICS OF CONCRETE: PHYSICAL, MECHANICAL AND MORPHOLOGICAL PROPERTIES

Bahattin ÖZTOPRAK, Can DEMİREL, Uğur SOYKAN..... 1

## **CHAPTER 2**

WASTE TO ENERGY GENERATION POTENTIAL OF MUNICIPAL SOLID WASTE: CASE FOR TR-61 REGION OF TURKEY

Zuhal AKYÜREK, Semih COŞKUN ..... 21

## **CHAPTER 3**

3D PRINTERS AND APPLICATIONS

Erdal ÖZBAY, Feyza ALTUNBEY ÖZBAY ..... 35

## **CHAPTER 4**

ANALYZING EFFECTS OF DIMENSIONS OF SUSTAINABILITY ON HUMANITARIAN LOGISTICS

Batin Latif AYLAK..... 63

## **CHAPTER 5**

SUBJECTIVE WEAR TRIALS OF SPORTSWEAR

Esra Taştan Özkan..... 77

## **CHAPTER 6**

INVESTIGATION OF MEDICINAL AND AROMATIC PLANT SPECIES IN COSMETICS

Ece Türedi, Nil Acaralı ..... 99

## **CHAPTER 7**

DESIGN OPTIMIZATION OF DISCONE ANTENNA USING META-HEURISTIC OPTIMIZATION

Serdal KARAHAN, Peyman MAHOUTİ..... 113

## **CHAPTER 8**

APPLICATION OF HEAT TREATMENT PROCESS TO AISI 2080 STEEL

Halil Ibrahim KURT, Hatice Ozge ALAGOZ, Hanim KAYA

Utku Berk AKYUZ, Damra Nisa DAL, Okan SERT ..... 125

**CHAPTER 9**

USE OF THE ELECTROMAGNETIC SPECTRUM IN THE  
MEDICAL FIELD

Yasin DOĞANŞAH, Murat KOKLU ..... 139

**CHAPTER 10**

NEW CONCEPTS OF ADDITIVE MANUFACTURING  
TECHNIQUES: 5D AND 6D PRINTING

Meltem ERYILDIZ ..... 165

**CHAPTER 11**

BIOMIMETIC STUDIES IN MECHANICS

Berkant DİNDAR ..... 179

**CHAPTER 12**

EFFECT OF OPTIMIZATION METHODS ON OPTIMUM DESIGN  
OF TUNED MASS DAMPER FOR MULTI-STORY STRUCTURES

Onur ARAZ..... 187

**CHAPTER 13**

NATURAL LANGUAGE PROCESSING TECHNIQUES

Seyma SARIGIL, Murat KOKLU ..... 205

**CHAPTER 14**

PACKAGING DEMAND FORECAST IN LOGISTICS USING CNN  
AND LSTM MODELS

Yashwanth BACHU, Mehmet KARABULUT,  
Huseyin KUSETOGULLARI ..... 219

**CHAPTER 15**

ANALYSIS OF THE FACTORS INFLUENCING THE POINT TO  
POINT (P2P) CONNECTION IN THE 5G MOBILE NETWORK

Teodor Iliev, Ivaylo Stoyanov, Grigor Mihaylov ..... 241



## **CHAPTER 1**

### **INFLUENCE OF ALGINATE POLYMER AND LIQUID SILICATE DERIVATIVES ADDITION ON FUNDAMENTAL CHARACTERISTICS OF CONCRETE: PHYSICAL, MECHANICAL AND MORPHOLOGICAL PROPERTIES**

*Bahattin ÖZTOPRAK<sup>1</sup>  
Can DEMİREL<sup>2</sup>  
Uğur SOYKAN<sup>3</sup>*

---

1 Assist. Prof. Dr., Bolu Abant İzzet Baysal University, Yenicaga Yasar Celik Vocational School, Bolu, Turkey, 14300. Orcid ID: 0000-0001-9386-9466.

2 Lecturer, Kırklareli University, Pinar Hisar Vocatioanl School, Kırklareli, Turkey, 71000. Orcid ID: 0000-0003-0417-8327.

3 Assist. Prof. Dr., Bolu Abant İzzet Baysal University, Yenicaga Yasar Celik Vocational School, Bolu, Turkey. 14300. Orcid ID: 0000-0002-9244-026

## 1- A brief overview on concrete and its additives

Concretes are the most widely used and favorable building materials since they meet the needs of human being such as the shelter and protection against to the external danger, and their importance is maintained today. It is well-known the fact that a concrete consists of components such cement (to enhance binding feature), water, fine aggregate, coarse aggregate and the additives with the percentage ratio of 7-15 %, 14-18 %, 24-28 %, 30-50 % and, not exceeding 5 % of dosage of the cement, respectively. Moreover, the concrete includes approximately 0.5-8 % of atmospheric air inside it. Furthermore, since the concrete is a durable, safe, economic, easily shapeable as well as easy production material (Stroeven & Hu, 2006), it has been used in lots of constructions and buildings such as house, bridge, road, dam, tunnel, barrier etc. Because of this widely usage potential, the improvement of the physical and chemical features of the concrete by using the different methods has become a more critical phenomenon focused by the scientists (Gencel, 2011; Kakae et al., 2017), which is performed by utilizing functional additives, changing or improving the aggregate properties, by producing high quality cement etc. (Eui-Hwan, Ko, & Jeon, 2007; Evangelista, Guedes, de Brito, Ferro, & Pereira, 2015).

When delving into the concrete additives, one of the most widely used and commercially important concrete components undoubtedly is organic or inorganic additives (Aquilina, Borg, & Buhagiar, 2018; Smirnov, 2022), which are used in different proportions and have different chemical forms. These materials added to the concrete matrix before or during the mixing process are defined as concrete additives. Additives are generally obtained from chemical methods, industrial wastes or natural sources. They are categorized as chemical, air-entraining, fine-grained mineral and other types (anti-corrosion, anti-moisture, colorant, etc.) additives. As important as the amounts of cement, aggregate and water are, the amount/ratio of the concrete admixture is also very important for the final performance of the resulting concrete (French, 1991). By adding the mentioned concrete additives (water reducer, set retarder or accelerator, binder, etc.) into the concrete matrix, physical and chemical modifications can be made to the concrete, which is especially important in terms of being able to be used everywhere and gaining some desired properties (Gurinenko & Batyanovskiy, 2019; Lermen et al., 2019; Raghav et al., 2021). For example, with the modifications made, the improvement in the mechanical and thermal resistance, biological durability, workability, fire, frost and chemical resistances, hardness properties are available in the literature (Bodnarova et al., 2020; Ekinci, Turkmen, Kantarci, & Karakoc, 2019; Esen & Orhan, 2016; Gallegos-Villela et al., 2021; Morozova, Arkady, Makhova, & Frolova,

2015). In the study by Nagrockiene et al. (Nagrockiene, Girskas, & Skripkiunas, 2017), the properties of concrete were modified by using mineral additives.

The findings obtained from the study showed that when the mineral admixture is more than 10 %, it caused an increase in compressive strength of 15.01 % in 7-day concrete samples, 13.27 % in 28-day concrete samples and 9.05 % in 6-month concrete samples. In addition, it was found that the water absorption of the concrete decreased and the estimated freeze-thaw strength increased when it contained more than 10 % mineral additives. Another research on concrete additives was done by Tseng et al. (Tseng, Huang, & Hsu, 2005). In their study, they stated that the zeolite added to the cement mixture at the rate of 15 % increased the early-age strength of the concrete and the hydration time decreased with the use of zeolite. Chinese researchers Peng et al. (Peng et al., 2007) investigated the effects of silica fume and fly ash on the freeze-thaw resistance (durability) and porosity of concrete. The experimental results showed that the addition of pozzolanic additives to the concrete mix increased the pore volume and average pore size. As a result of this situation, it was also stated that concrete showed better freeze-thaw resistance. Mendivil-Escalante et al. (Mendivil-Escalante, Gomez-Soberon, Almaral-Sanchez, & Cabrera-Covarrubias, 2017), on the other hand, succeeded in reducing the porosity of concrete by 30 % and increasing its mechanical properties by using polyethylene terephthalate (PET) based admixtures as a concrete additive. In addition, it has been proven by scientific studies that by adding different polymeric additives to the concrete matrix, mechanical resistance and durability are added to the concrete (Khayat, 1998; Son & Yeon, 2012). In addition, it is seen in the researches that especially silicate derivatives and chemical additives increasing the intermolecular interactions allow the production of concrete with improved thermal and mechanical properties, surface modifications and increasing the compatibility (adhesion) of the components that make up the concrete (Bederina, Khenfer, Dheilily, & Queneudec, 2005; Frybort, Vsiansky, Stulirova, Stryk, & Gregerova, 2018; Kheder & Al-Windaw, 2005; Zhang, Zhan, Wu, Wang, & Xu, 2016). Because silicate derivatives, which are inorganic mineral additives, are in chemical harmony with concrete components and prevent undesired phase separation in concrete. In addition, silicate derivatives react with calcium hydroxide, which is formed as a result of the reaction between cement and water, filling the voids in the concrete and increasing the strength of the concrete by accelerating nucleation (Thompson, Silsbee, Gill, & Scheetz, 1997). In addition, it is known in the literature that when silicate derivatives are added to concrete, they increase the water impermeability of concrete by reducing capillary spaces (Dong et al., 2017; Gandolfi, Iacono, Pirani, & Prati, 2012; Odler

& Koster, 1991). For example, a study by Jiang et al. (Jiang et al., 2015) revealed that the use of sodium silicate-based concrete sealant increased both the waterproofing property and the gelation time due to low surface tension. Additionally, liquid silicates with variable molar ratios, percentages and densities are also used in the construction industry by treating silicate derivatives (especially sodium, potassium and lithium silicates) with high pressure and water [34]. Since liquid silicates have low production cost, alkalinity, hardening, binding capacity, resistance to corrosion, they are preferred mostly. In addition, they can react with concrete components or other building materials (for example, iron) and turns into insoluble silicates in the concrete matrix. On the other hand, polymer-based chemical additives are used to increase the intermolecular interaction between the concrete components (especially to provide steric interaction and to increase the Van der Waals attraction forces) (Lasheras-Zubiate, Navarro-Blasco, Fernandez, & Alvarez, 2012). This is possible with the mortar components consisting of fine aggregate and cement paste and the functional groups in the chemical additives making intramolecular and intermolecular chemical bonds (Nematzadeh & Fallah-Valukolae, 2017; Stroeve, 1984). Therefore, the compatibilization (compatibility) of concrete additives with concrete components is important in order to give improved properties to the concrete matrix. With this purpose, Akindahunsi and Uzoegbo (Akindahunsi & Uzoegbo, 2015) investigated how the properties of concrete such as strength, oxygen permeability and oxygen absorption change by adding starch, as an organic substance, to the concrete mixture. The results of the analysis clearly showed that in the 28-day concrete samples with 0.5 % starch, the compressive strength increased due to the high bonding strength of starch, and also that starch improved the durability properties of the concrete. In addition to the providing compatibility, there are lots of studies showing that the addition of starch polymer in to the concrete affects the fundamental characteristic properties such as frost resistance (Sybis & Konowal, 2019), electrochemical (Ikotun & Afolabi, 2013), thermal, acoustic and mechanical (Li, Gacoin, & Mai, 2013), durability performance (Saboktakin & Saboktakin, 2014; Sandrine, Isabelle, Hoang, & Chadi, 2015).

All in all, every study to be carried out in order to develop concrete will both contribute to the literature and guide scientists who will work on such materials, industry and construction applications. Thus, in this multi-disciplinary study, the alginate, liquid sodium and potassium silicates were utilized as a chemical additive in solution form thanks to that alginate has a biopolymer character in a polysaccharide structure connected to each other with a flexible bond and it contains many hydroxyl (-OH) groups and liquid silicate derivatives could bond with the cations in the concrete matrix. In ad-

dition, the changes in the properties of the produced concretes were investigated in detail and, the optimum content level of the additive was determined by discussing filler and binding effect of them.

## 2- Materials and Methods

The main chemicals , liquid sodium silicate and liquid potassium silicate were kindly purchased from Ozkimsan company (Bolu Organized Industrial Zone). The another main compound, sodium alginate was obtained from Sigma Aldrich (Missouri, USA) in order to prepare the solution used as the liquid concrete additive. Other chemicals and solvents in this current work were utilized as supplied from the companies without any additional purifications. CEM I 42.5R Portland cement was supplied from Kırklareli Limak Cement Factory and this material was used in accordance with TS EN 197-1. The density of cement was  $3.14 \text{ g/cm}^3$  and, the chemical properties of the taken cement were given in Table 1. As for the used aggregate, Limak Trakya Cement Factory product CEN standard sand was used as fine aggregate for the production of concretes in accordance with the TS EN 196-1 standard. Kırklareli center city mains water was utilized as mixing water in the concrete mixtures.

**Table 1.** *Chemical properties of CEM I 42.5R cement.*

Oxides	(%)
SiO <sub>2</sub>	20.57
Al <sub>2</sub> O <sub>3</sub>	4.61
Fe <sub>2</sub> O <sub>3</sub>	3.72
CaO	63.29
MgO	1.25
Na <sub>2</sub> O	0.32
K <sub>2</sub> O	0.89
SO <sub>3</sub>	3.01
Cl	0.01
insoluble residue	0.50
glow loss	3.17
specific surface (Blaine) cm <sup>2</sup> /g	3414

Additionally, in this study, six different solutions as an additive were prepared for the production of concretes by mixing separately liquid potassium silicate (LPS), liquid sodium silicate (LSS), and 1% of alginate aqueous solution (ALJ). The volumetric mixing ratio of these solutions used as an

additive were given in Table 2. First, during the concrete mortar production, the water/cement ratio was kept the constant of 0.5. Accordingly, the concrete matrices were prepared by the combination of 450 g of cement, 1350 g of CEN standard sand, 225 g of water (1 unit cement, 3 units CEN standard sand, ½ unit water). After mixing, the previously prepared 6 concrete solution additives were added to this concrete matrix at the ratios of 1.0 %, 2.0 %, 3.0 %, 4.0 % and 5.0 % with respect to total volume of the used water. Then, the mixture including the additive solution were placed in a three-eyed prism mold (40x40x160mm<sup>3</sup>). After concrete samples were waited in this mold for 1 day, the concrete specimens were kept in the curing pool for another 1 day. Then, they were removed from the curing pool and, kept at the temperature of 20±2 °C and the relative humidity of 90±5 % for both 7 days and 28 days to reach ambient condition until the day of the experimental tests. Three parallel samples of each types of concretes were produced and the results were obtained with the calculated standard deviations. The densities of the obtained concrete samples were determined according to ASTM C 642 (Ramakrishnan et al., 2021) after 28-days curing at room temperature.

**Table 2.** *Concrete admixture ratios*

Mixture	Percent volume of silicate derivatives	Percent volume of ALJ%1
1	30 % of LPS	70 %
2	40 % of LPS	60 %
3	50 % of LPS	50 %
4	30 % of LSS	70 %
5	40 % of LSS	60 %
6	50 % of LSS	50 %

The compression tests of both 7-days and 28-days cured concrete specimens were conducted by using 1000 kN universal testing machine according to TS EN 196- 1 (Akyuncu & Sanliturk, 2021). The compression strengths were calculated as the breaking load per unit area with the use of three parallels for each tests. Similarly, tree-point bending tests (flexural tests) of the produced beam specimens were performed according to TS EN 196-1 (Akyuncu & Sanliturk, 2021) by applying the force to the centre points. The morphology of the fractured surfaces obtained from both compression and flexural tests was examined by means of scanning electron microscope (SEM) FEI–Quanta FEG 250 that operated at 10 kV. The SEM images were taken in the secondary electron image (SEI) mode with a resolution power of 3 nm at 10000x magnification. The chemical compositions of the fractured surfaces belonging to produced concretes were determined with



the use of EDX-mapping. Before SEM analysis, all the fractured concrete samples were coated with gold in order to make their surfaces conductive and, thus take desired images.

### 3. Physical properties of the produced concretes

The fundamental aim in the concrete production engineering is to obtain a void-free and high-strength concrete as much as possible. In addition, its resistance against to the external physical and chemical effects can be seen as an another determining parameters. The most important physical properties of concrete used as a building materials are its strength, porosity, permeability, density, elasticity and thermal properties. These properties determine the final performance of the concretes. Among them, it is well-known the fact that the density of the concrete is a significant one that affecting directly its mechanical performance, porosity level, structural efficiency, absorption capacity etc. of the final concrete (Chen, Peng, Zhang, & Liu, 2013). Simply, the density of the concrete can be seen as a measure of concrete quality. The density of the concrete is also directly related to the amount of the used components such as water, cement, sands and additives and, the strength of concrete can be approximated with the help of density. Because of that, in order to figure out the effect of the adding solution to the main properties of the produced concretes, the densities of the concrete specimens containing different percentage of LSS/ALJ additives were determined according to the related standard. The calculated data were drawn in Figure 1. As depicted in the figure, the dry density of fabricated concretes treated with LSS/ALJ solution illustrated a diminishment trend accompanied by some deviations, except for concrete samples containing 1 % and 2 % LSS/ALJ. Correspondingly, the density of reference concrete was found to be roundly  $2.34 \text{ g/cm}^3$ , whereas the lowest and maximum densities values were recorded as  $2.38 \text{ g/cm}^3$  and  $2.14 \text{ g/cm}^3$  at the concrete sample with 2 % of 30/70 LSS/ALJ and 4 % of 50/50 LSS/ALJ solution, respectively. Although the addition of LSS/ALJ at all mixing ratios resulted in a decrease in the density of the concrete samples, the observed slight increment at low contents was believed to caused from that the incorporation of more alginate molecules resulted the formation more chemical interactions between the functional group of alginate and the concrete component. However, it seemed that the introduction of liquid silicates into the concrete matrix brought about the increment in the porosity (voids) level of the concrete, which ends up the relatively lower density, as seen in SEM analysis (Figure 6).

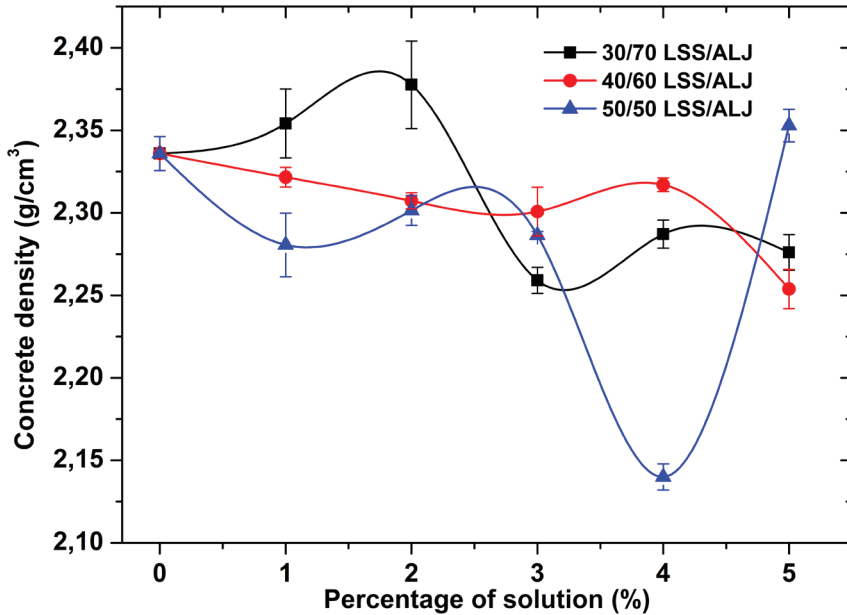
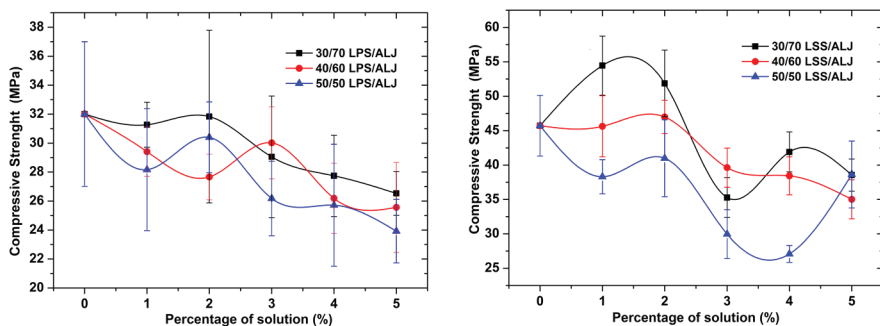


Figure 1. Variation of the dry densities of the concretes with the percentage of LSS/ALJ.

#### 4. Mechanical properties of the produced concretes

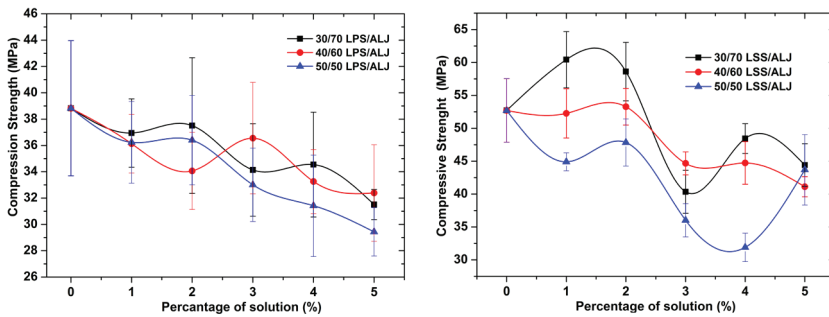
Mechanical performance of the fabricated concretes was determined by both compressive and flexural strength tests according to relevant standards in this part of the study. First, in order to find out the concrete resistances against to break under compression force, the compressive tests of the produced concretes samples were performed according to the relevant standard. The recorded data for 7 and 28-days were drawn schematically in Figure 2 and Figure 3, respectively. When examining Figure 2, almost all the concrete samples including LPS/ALJ showed lower compressive strength performance when compared to neat concrete. The compressive strengths of the reference concrete samples with LPS/ALJ and LSS/ALJ were found to be 32.00 MPa and 45.73 MPa. Among samples, the lowest values were recorded at 5 % of solution levels for both types of additives. Namely, especially when we focused on the LPS/ALJ for 7-days concrete specimens, it seemed that the increasing of the percentage of the solution level in the concrete matrices made the concrete more vulnerable to applied compression force. Moreover, it must to be stated here that the presence of relatively higher amount of LPS in these concrete specimens, which means the decrement in the percentage of ALJ in the solution mixture, caused that 7-days concrete samples depicted lower compression strengths. Correspondingly, the lowest compression strengths values, 23.53 MPa, 25.56 MPa, 23.92 MPa were recorded at the concrete sample with 5 % of 30/70 LPS/ALJ, 40/60 LPS/

ALJ and 50/50 LPS/ALJ, respectively. This result may be attributed to the decrement in both the water demand and the binding effect of ALJ bearing structurally functional groups having a potential to bind with the concrete since the amount of ALJ reduced in the matrix (Abolhasani, Nazarpour, & Dehestani, 2021). On the other hand, when examining LSS/ALJ-added concrete samples, it could be seen that the initial addition of 30/70 LSS/ALJ solution to the concrete matrix created the positive effect on the compression strength. That is, unlike LPS/ALJ, at the concrete specimen containing 1 % and 2 % of 30/70 LSS/ALJ solution, the compression strength values were recorded as 54.45 MPa and 51.86 MPa, respectively. These values were 19.1 % and 13.4 % higher than the value that reference concrete had (45.72 MPa). This may be caused by LSS/ALJ solution depicted more influential filler and binding effect since sodium atom is a smaller particle at the molecular level than potassium. In addition, the stronger intermolecular bonds between ALJ and LSS may form due to the presence of sodium atom as a common ion in the additive solution medium. In accordance with that, since the decrement in the porosity degree in the concrete led to the augmentation in the compressive strength (Tran, Dhakal, & Scott, 2020), the higher compression strength were obtained at these samples. In addition to that, the formation of more intermolecular binding thanks to the OH groups of alginates may give rise to the increment in the endurance ability of the concretes when the compression force was applied (Rasa, Ketabchi, & Afshar, 2009). As observed in SEM images belonging to relevant sample, the formation of the apparent strong chemical bonds such as C-S-H and C-H with ettringite crystals, occurrence of structures with relatively lower porosity level, and the absence of relatively higher amount of gaps and cracks supported these results. Furthermore, similarly, the decrement in the amount of ALJ at these sample gave rise to that the samples get worse. All things considered, at the 7-days concrete samples, in general, the compressive strengths were affected negatively by the enhancement of the content level of both liquid silicates derivatives, although some deviations were recorded as seen apparently in Figure 2.



**Figure 2.** Compressive strengths of the produced concretes containing different types of liquid silicate derivatives after 7 days.

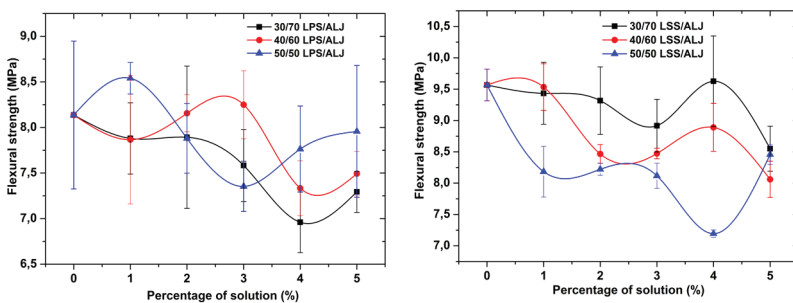
In addition, 28-days concrete samples were also analyzed and, the variation of the compressive strength of these samples with the content level of both LPS/ALJ and LSS/ALS were illustrated in Figure 3. First, it could be said that 28-days concrete samples showed similar trend with 7-days concrete specimens produced. That is, both the increasing of percentage of solution in the concretes and the enhancement in the amount of the liquid silicate derivatives in the additive solution led to the diminishment in the compression strengths of the concrete samples. This may be attributed to the damaging of the bonds between the cement and aggregates in the concrete during curing (Arefi & Rezaei-Zarchi, 2012). Moreover, as expected, one could deduced from the figure that 28-days concretes possessed relatively higher compression strengths when compared to relevant 7-days concrete specimens since the concretes gained 99.9 % of its strength. All in all, in terms of compression strength, the optimum addition levels to produce the concrete having improved strength were found to be 1 % and 2 % of 30/70 LSS/ALJ for 7-days and 28-days cured concretes.



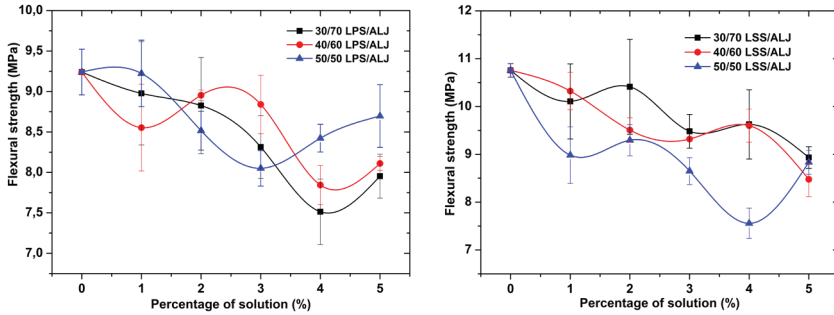
**Figure 3.** Compressive strengths of the produced concretes containing different types of liquid silicate derivatives after 28 days.

Concrete must meet the construction and building field demands. Thus, especially when a novel additive material is developed so as to improve the fundamental properties of the concrete, it is necessary to know what effect it creates on concrete. With this aspect, in addition to the compressive strength test, the flexural strength is also required to establish the laboratory concrete mix design since this test enables us to evaluate the tensile strength indirectly (Umasabor & Daniel, 2020). When a force is applied from the certain point of the concrete samples, the flexural strength can be defined as a measure of the failure withstanding in bending and, the test results were also expressed as a rupture modulus (Tolmachov, Belichenko, & Zakharov, 2017). The cracking and deflection behavior of the concretes could be estimated by the flexural strength. Flexural strength of the concrete is roundly 10-20 % of the compressive strength depending on the structural properties of coarse aggregate (its type, size and volume), the used cement and additives. Moreover, it must be stated herein that the flexural strength possesses

the considerably sensitivity against the preparation of the concrete sample, handling as well as the curing process. In the light of the things mentioned above, in this part of the paper, the flexural performance of the produced concrete samples containing varying amount of both LPS/ALJ and LSS/ALJ solution were determined and the recorded data were shown schematically in Figure 4 and 5. Both compression and flexural strengths showed a good correlation with the density findings as expected. According to figures, it could be seen that LSS/ALJ additive showed better performance when compared to the LPS/ALJ additives. Moreover, almost all samples cracked more easily during bending as the LPS/ALJ and LSS/ALJ content levels increased. In other words, the presence of more amount liquid silicate derivatives and alginate polymer in the concrete presumably enhanced the stress level of the concretes since the applied force could not be effectively distributed throughout concrete, which make the specimens more brittle. Thus, the cracks in the concrete move more easily, causing the occurrence of the relatively deeper cracks inside the concrete matrices. On the other hand, when focusing on the 7-days cured samples, the increasing of liquid potassium silicate contents led to some reinforcement at initial and moderate levels, on the contrary, the enhancing of the amount of the liquid sodium silicate gave rise to the reduction in the flexural strength. This may be related to the confinement of the concretes fabricated (Maulana & Irfani, 2019). Furthermore, as seen from the figure, the increment in the alginate content in the additive solution made the concrete sample with LPS/ALJ more strength, but this effect was lost at high contents. At the samples cured for 28-days, the similar behavior was observed, Figure 5. In short, the additives including liquid silicate derivatives and alginates damage to the structure of the samples and brought about that the cracks were initiated more easily in the interfacial zones.



**Figure 4.** Flexural strengths of the produced concretes containing different types of liquid silicate derivatives after 7 days.



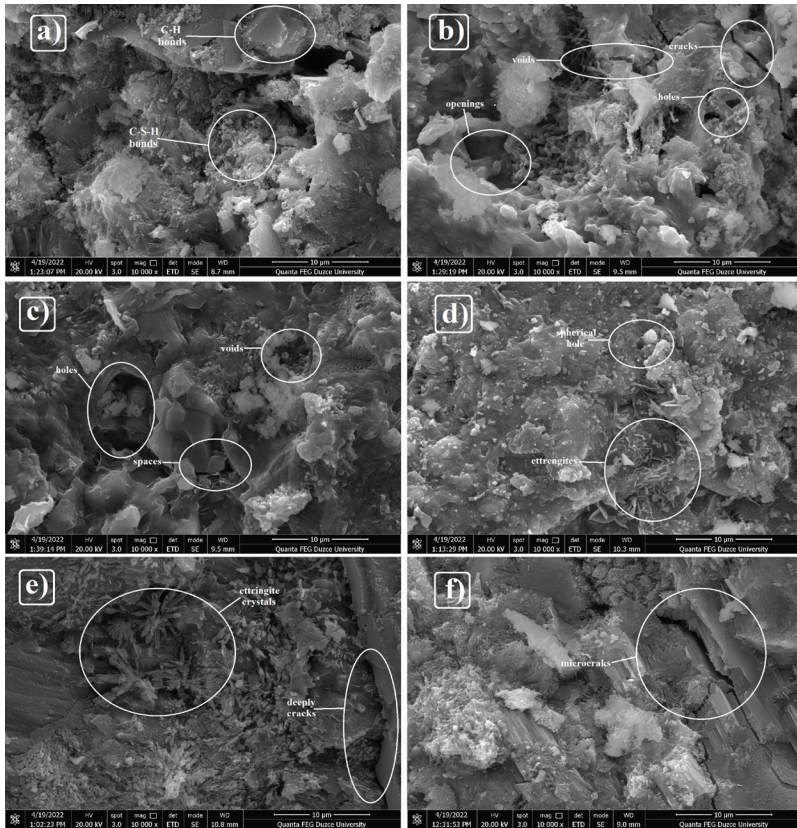
**Figure 5.** Flexural strengths of the produced concretes containing different types of liquid silicate derivatives after 28 days.

## 5. Morphological analysis of produced concretes

In this part of the study, the micrographs of the fractured surfaces taken from only compression strength tests of the concrete samples were pictured by means of scanning electron microscope (SEM) analysis. Moreover, In order to find out the chemical composition of the specimens, what elements are included, the element distribution and regional content level, energy-dispersive X-ray (EDX ) analysis were also performed. The taken SEM images and EDX spectra belonging to the chosen concrete samples were illustrated in Figure 6 and Figure 7, respectively. As observed from the SEM image (Figure 6.a) obtained from the 28-days cured concrete sample with 1 % of 30/70 LSS/ALJ after compression test, there existed demanded C-S-H and C-H gel structures throughout the concrete matrix without any phase separation and cracks, which was provided by the better binding of the components and the increment in the chemical interaction in the matrix. This also can be seen as a experimental clue why this sample showed better compression strength among samples. Furthermore, as correlated with density and mechanical test results, SEM images revealed that the formation of porosity level (amount of voids) increased with the increasing of solution content. Accordingly, when glancing the fractographs b and c, spaces, pores, holes and void observed more frequently at high content when compared to low content. Additionally, almost spherical holes caused by the evaporation of water from the concrete matrices as well as ettringites with needle-like appearance due to the C-H and C-S-H bonds were seen in almost all SEM images. The deep and large cracks due to the low mechanical performance were more intensely seen in the fractured surface of the concrete samples with high content of additives, Figure 6.d and e. All in all, the addition of high amount of both LPS/ALJ and LSS/ALJ additives damaged the microstructure of the produced concrete samples as depicted in Figure 6. In addition to SEM analysis, the typical EDX spectra belonging to the fractured surfaces of the concrete samples with different percentage of LSS/ALJ and LPS/ALJ



additives showed that the percentage of Si, O and C enhanced with the LSS/ALJ and LPS/ALJ contents in the concrete. The reason for the increase in the percentage of Si and O was apparently LSS or LPS added to the concrete sample, whereas the increase in the carbon percentage was obviously due to ALJ as seen in Figure 7.



**Figure 6.** SEM images of the fractured surfaces of the 28-days cured concretes containing a) 1 % 30/70 LSS/ALJ, b) 5 % of 30/70 LSS/ALJ, c) 5 % of 50/50 LSS/ALJ, d) 1 % of 30/70 LPS/ALJ, e) 3 % of 40/60 LPS/ALJ and f) 5 % of 50/50 LPS/ALJ from the compressive strengths tests.

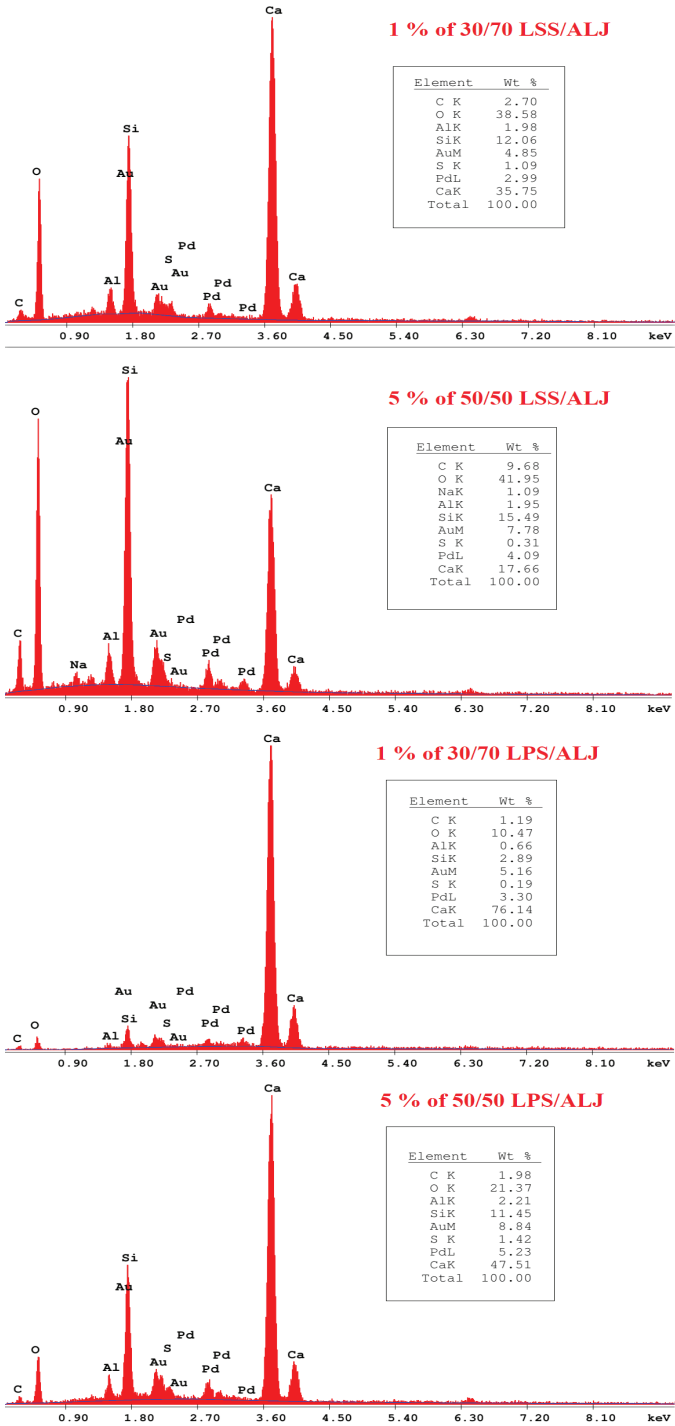


Figure 7. EDX output of the fractured surfaces of the 28-days cured concretes from the compression tests..



## 6. Conclusion

In this current study, we tried to investigate the change in the structural, mechanical and morphological features of the concretes produced with the addition of varying content level of LPS/ALJ and LSS/ALJ. The six novel mixtures having different LPS, LSS and ALJ percentages were prepared for the concrete samples produced as 7-days and 28-days cured. It was concluded that all the densities of the concretes decreased consistently with the increasing of the percentage of the additives. This probably caused by the formation of novel omnipresent voids (spaces) in the concrete matrices. Moreover, the mechanical test results revealed that, in comparison with the reference concrete, the presence of liquid silicates and alginates in the concrete matrices brought about relatively lower compressive and flexural strengths. However, among concrete samples, 19.1 % and 13.4 % reinforcements were recorded at the concrete product with 1 % and 2 % of 30/70 LSS/ALJ solution. This could be attributed to the filler behaviour of silicates, formation of more effective interaction between the functional groups of alginates polymers and the cations in the concrete matrix. Thus, these content was found to be optimum additive level in this study. Furthermore, the SEM images depicted that the topology of the resulting concretes were considerably influenced by additives. Relatively high amount of the openings (voids) and cracks were especially observed at high content of LPS/ALJ and LSS/ALJ additive.

## Acknowledgement

This multidisciplinary work was supported by Bolu Abant İzzet Baysal University and Kırklareli University. Moreover, the authors wishes to express their gratitude to Özkimsan Company from Bolu and Kırklareli Limak Cement Factory for supplying the liquid silicate derivatives and the raw materials (cement and aggregate) used for the production of concretes, respectively.

## REFERENCES

- Abolhasani, A., Nazarpour, H., & Dehestani, M. (2021). Effects of silicate impurities on fracture behavior and microstructure of calcium aluminate cement concrete. *Engineering Fracture Mechanics*, 242.
- Akindahunsi, A. A., & Uzoegbo, H. C. (2015). Strength and Durability Properties of Concrete with Starch Admixture. *International Journal of Concrete Structures and Materials*, 9(3), 323-335.
- Akyuncu, V., & Sanliturk, F. (2021). Investigation of physical and mechanical properties of mortars produced by polymer coated perlite aggregate. *Journal of Building Engineering*, 38.
- Aquilina, A., Borg, R. P., & Buhagiar, J. (2018). The application of Natural Organic Additives in Concrete: *Opuntia ficus-indica*. *Fib Conference: Sustainable Concrete: Materials and Structures*, 2018, 442.
- Arefi, M. R., & Rezaei-Zarchi, S. (2012). Synthesis of Zinc Oxide Nanoparticles and Their Effect on the Compressive Strength and Setting Time of Self-Compacted Concrete Paste as Cementitious Composites. *International Journal of Molecular Sciences*, 13(4), 4340-4350.
- Bederina, M., Khenfer, M. M., Dheilily, R. M., & Queneudec, M. (2005). Reuse of local sand: effect of limestone filler proportion on the rheological and mechanical properties of different sand concretes. *Cement and Concrete Research*, 35(6), 1172-1179.
- Bodnarova, L., Tazky, M., Tazka, L., Hela, R., Pikna, O., & Sitek, L. (2020). Abrasive Wear Resistance of Concrete in Connection with the Use of Crushed and Mined Aggregate, Active and Non-Active Mineral Additives, and the Use of Fibers in Concrete. *Sustainability*, 12(23).
- Chen, Y., Peng, M., Zhang, Y., & Liu, Y. J. (2013). Mechanical Properties of Autoclaved Aerated Concrete with Different Densities. *Advances in Civil Engineering Materials*, 2(1), 441-456.
- Dong, S. J., Wang, L. Y., Gao, X. L., Zhu, W. Z., Wang, Z., Ma, Z., & Gao, C. J. (2017). Freeze casting of novel porous silicate cement supports using tert-butyl alcohol-water binary crystals as template: Microstructure, strength and permeability. *Journal of Membrane Science*, 541, 143-152.
- Ekinci, E., Turkmen, I., Kantarci, F., & Karakoc, M. B. (2019). The improvement of mechanical, physical and durability characteristics of volcanic tuff based geopolymer concrete by using nano silica, micro silica and Styrene-Butadiene Latex additives at different ratios. *Construction and Building Materials*, 201, 257-267.
- Esen, Y., & Orhan, E. (2016). Investigation of the effect on the physical and mechanical properties of the dosage of additive in self-consolidating concrete. *Ksce Journal of Civil Engineering*, 20(7), 2849-2858.
- Eui-Hwan, H., Ko, Y. S., & Jeon, J. K. (2007). Effect of polymer cement modifiers

- on mechanical and physical properties of polymer-modified mortar using recycled waste concrete fine aggregate. *Journal of Industrial and Engineering Chemistry*, 13(3), 387-394.
- Evangelista, L., Guedes, M., de Brito, J., Ferro, A. C., & Pereira, M. F. (2015). Physical, chemical and mineralogical properties of fine recycled aggregates made from concrete waste. *Construction and Building Materials*, 86, 178-188.
- French, W. J. (1991). Concrete Petrography - a Review. *Quarterly Journal of Engineering Geology*, 24(1), 17-48.
- Frybort, A., Vsiansky, D., Stulirova, J., Stryk, J., & Gregerova, M. (2018). Variations in the composition and relations between alkali-silica gels and calcium silicate hydrates in highway concrete. *Materials Characterization*, 137, 91-108.
- Gallegos-Villela, R. R., Larrea-Zambrano, F. D., Goyes-Lopez, C. E., Perez-Sanchez, J. F., Suarez-Dominguez, E. J., & Palacio-Perez, A. (2021). Effect of natural additives on concrete mechanical properties. *Cogent Engineering*, 8(1).
- Gandolfi, M. G., Iacono, F., Pirani, C., & Prati, C. (2012). The use of calcium-silicate cements to reduce dentine permeability. *Archives of Oral Biology*, 57(8), 1054-1061.
- Gencil, O. (2011). Physical and mechanical properties of concrete containing hematite as aggregates. *Science and Engineering of Composite Materials*, 18(3), 191-199.
- Gurinenko, N. S., & Batyanovskiy, E. I. (2019). Influence of Polyfunctional Additive on Hardening Process and Properties of Cement Concrete. *Science & Technique*, 18(4), 330-338.
- Ikotun, B. D., & Afolabi, A. S. (2013). Electrochemical behaviour of an austenitic stainless steel reinforced concrete in the presence of starch and cellulose admixtures. *Construction and Building Materials*, 42, 22-28.
- Jiang, L. H., Xue, X., Zhang, W. D., Yang, J. N., Zhang, H. Q., Li, Y. W., . . . Qin, J. (2015). The investigation of factors affecting the water impermeability of inorganic sodium silicate-based concrete sealers. *Construction and Building Materials*, 93, 729-736.
- Kakae, N., Miyamoto, K., Momma, T., Sawada, S., Kumagai, H., Ohga, Y., . . . Abiru, T. (2017). Physical and Thermal Properties of Concrete Subjected to High Temperature. *Journal of Advanced Concrete Technology*, 15(6), 190-212.
- Khayat, K. H. (1998). Viscosity-enhancing admixtures for cement-based materials - An overview. *Cement & Concrete Composites*, 20(2-3), 171-188.
- Kheder, G. F., & Al-Windaw, S. A. (2005). Variation in mechanical properties of natural and recycled aggregate concrete as related to the strength of their binding mortar. *Materials and Structures*, 38(281), 701-709.
- Lasheras-Zubiate, M., Navarro-Blasco, I., Fernandez, J. M., & Alvarez, J. I. (2012). Effect of the addition of chitosan ethers on the fresh state properties of ce-

ment mortars. *Cement & Concrete Composites*, 34(8), 964-973.

- Lermen, R. T., Favaretto, P., Silva, R. D., Hidalgo, G. E. N., Tubino, R. M. C., & Tiecher, F. (2019). Effect of Additives, Cement Type, and Foam Amount on the Properties of Foamed Concrete Developed with Civil Construction Waste. *Applied Sciences-Basel*, 9(15).
- Li, A., Gacoin, A., & Mai, T. H. (2013). Performance of hemp-starch concrete composite. *Applied Energy Technology, Pts 1 and 2*, 724-725, 1531-1534.
- Maulana, T. I., & Irfani, D. (2019). Compressive Behavior of Jacketed Specimens and Flexural Behavior of Concrete Beam Strengthened using Sodium Silicate Mortar. *International Journal of Integrated Engineering*, 11(9), 264-274.
- Mendivil-Escalante, J. M., Gomez-Soberon, J. M., Almaral-Sanchez, J. L., & Cabrera-Covarrubias, F. G. (2017). Metamorphosis in the Porosity of Recycled Concretes Through the Use of a Recycled Polyethylene Terephthalate (PET) Additive. Correlations between the Porous Network and Concrete Properties. *Materials*, 10(2).
- Morozova, M., Arkady, A., Makhova, T., & Frolova, M. (2015). Mineral Highly Dispersed Additive to Enhance the Frost Resistance of Concrete. *Nano, Bio and Green - Technologies for a Sustainable Future, Vol I (Sgem 2015)*, 135-142.
- Nagrokiene, D., Girskas, G., & Skripiunas, G. (2017). Properties of concrete modified with mineral additives. *Construction and Building Materials*, 135, 37-42.
- Nematzadeh, M., & Fallah-Valukolae, S. (2017). Effectiveness of fibers and binders in high-strength concrete under chemical corrosion. *Structural Engineering and Mechanics*, 64(2), 243-257.
- Odler, I., & Koster, H. (1991). Investigation on the Structure of Fully Hydrated Portland-Cement and Tricalcium Silicate Pastes .3. Specific Surface-Area and Permeability. *Cement and Concrete Research*, 21(6), 975-982.
- Peng, G. F., Ma, Q., Hu, H. M., Gao, R., Yao, Q. F., & Liu, Y. F. (2007). The effects of air entrainment and pozzolans on frost resistance of 50-60 MPa grade concrete. *Construction and Building Materials*, 21(5), 1034-1039.
- Raghav, M., Park, T., Yang, H. M., Lee, S. Y., Karthick, S., & Lee, H. S. (2021). Review of the Effects of Supplementary Cementitious Materials and Chemical Additives on the Physical, Mechanical and Durability Properties of Hydraulic Concrete. *Materials*, 14(23).
- Ramakrishnan, K., Ganesh, V., Vignesh, G., Vignesh, M., Shriram, V., & Suryaprakash, R. (2021). Mechanical and durability properties of concrete with partial replacement of fine aggregate by sugarcane bagasse ash (SCBA). *Materials Today-Proceedings*, 42, 1070-1076.
- Rasa, E., Ketabchi, H., & Afshar, M. H. (2009). Predicting Density and Compressive

Strength of Concrete Cement Paste Containing Silica Fume Using Artificial Neural Networks. *Scientia Iranica Transaction a-Civil Engineering*, 16(1), 33-42.

- Saboktakin, A., & Saboktakin, M. R. (2014). Improvement of reinforced concrete properties based on modified starch/polybutadiene nanocomposites. *International Journal of Biological Macromolecules*, 70, 381-384.
- Sandrine, U. B., Isabelle, V., Hoang, M. T., & Chadi, M. (2015). Influence of chemical modification on hemp-starch concrete. *Construction and Building Materials*, 81, 208-215.
- Smirnov, I. R. (2022). Complex Additives for Concrete Based on Substances of Organic and Mineral Nature. *Science & Technique*, 21(1), 57-62. doi: 10.21122/2227-1031-2022-21-1-57-62
- Son, S. W., & Yeon, J. H. (2012). Mechanical properties of acrylic polymer concrete containing methacrylic acid as an additive. *Construction and Building Materials*, 37, 669-679.
- Stroeva, G. Y. (1984). Improvement of Light Concrete Properties by Complex Chemical Additives Based on Water-Resistant Plaster Binders. *Izvestiya Vysshikh Uchebnykh Zavedenii Khimiya I Khimicheskaya Tekhnologiya*, 27(11), 1352-1355.
- Stroeven, P., & Hu, J. (2006). Review paper - stereology: Historical perspective and applicability to concrete technology. *Materials and Structures*, 39(1), 127-135.
- Sybis, M., & Konowal, E. (2019). The effect of cement concrete doping with starch derivatives on its frost resistance. *Przemysl Chemiczny*, 98(11), 1738-1740.
- Thompson, J. L., Silsbee, M. R., Gill, P. M., & Scheetz, B. E. (1997). Characterization of silicate sealers on concrete. *Cement and Concrete Research*, 27(10), 1561-1567.
- Tolmachov, S., Belichenko, O., & Zakharov, D. (2017). Influence of additives on flexural strength of concrete. *6th International Scientific Conference Reliability and Durability of Railway Transport Engineering Structures and Buildings (Transbud-2017)*, 116.
- Tran, H., Dhakal, R., & Scott, A. (2020). Mechanical and durability properties of magnesium silicate hydrate binder concrete. *Magazine of Concrete Research*, 72(13), 693-702.
- Tseng, Y. S., Huang, C. L., & Hsu, K. C. (2005). The pozzolanic activity of a calcined waste FCC catalyst and its effect on the compressive strength of cementitious materials. *Cement and Concrete Research*, 35(4), 782-787.
- Umasabor, R. I., & Daniel, S. C. (2020). The effect of using polyethylene terephthalate as an additive on the flexural and compressive strength of concrete. *Helikon*, 6(8).

Zhang, H., Zhan, S. L., Wu, H. T., Wang, J. H., & Xu, Y. (2016). Effect of Lithium Silicate Composite Sol on the Properties of Concrete Surface. *Rare Metal Materials and Engineering*, 45, 85-88.



## **CHAPTER 2**

### **WASTE TO ENERGY GENERATION POTENTIAL OF MUNICIPAL SOLID WASTE: CASE FOR TR-61 REGION OF TURKEY**

*Zuhal AKYÜREK<sup>1</sup>*

*Semih COŞKUN<sup>2</sup>*

---

1 Assoc. Prof Dr., Burdur Mehmet Akif Ersoy University, Faculty of Engineering and Architecture, Department of Energy Systems Engineering, Burdur, Turkey, (ORCID: 0000-0003-3102-4278), drzuhalakyurek@gmail.com

2 Assist. Prof. Dr., Pamukkale University, Faculty of Engineering, Department of Industrial Engineering, Denizli, Turkey, (ORCID: 0000-0001-5201-6563), scoskun@pau.edu.tr.

## 1. INTRODUCTION

The global threat of climate change and resource extinction has become more prominent all over the World in the last decades. The rapid growth in population, industrialization and economic development have brought along problems of waste management and continuously rising energy demand. In recent years, solid waste management has become a focus of interest due to increasing adverse impacts of solid waste on health and environment.

The concern on environmental sustainability has led to green production practices, eco-logical life cycles of products during supply chains. Designing products based on green initiatives, generating environmentally benign production environments and processes, warehouse management and designing forward and backward distribution networks based on green principles, waste management efforts are very important decision domains related to environmental sustainability (Coskun et al, 2016, Coşkun and Akgül, 2022).

Municipal solid waste (MSW) is generally treated in landfills or disposed of in open dumps (Themelis and Ulloa, 2007). Waste generation capacity across the world is expected to reach 3.40 billion tons by 2050 (World Bank, 2018). MSW generated in Europe vary considerably, ranging from 282 kg per capita in Romania to 845 kg per capita in Denmark (Eurostat, 2020, Figure 1). The differences in economic wealth and waste management strategies results in variation for waste produced. In Europe 48 % of the MSW is recycled. In EU, MSW generation was 505 kg/capita in year 2020 whereas it was 424 kg/capita in Turkey (Eurostat, 2020).

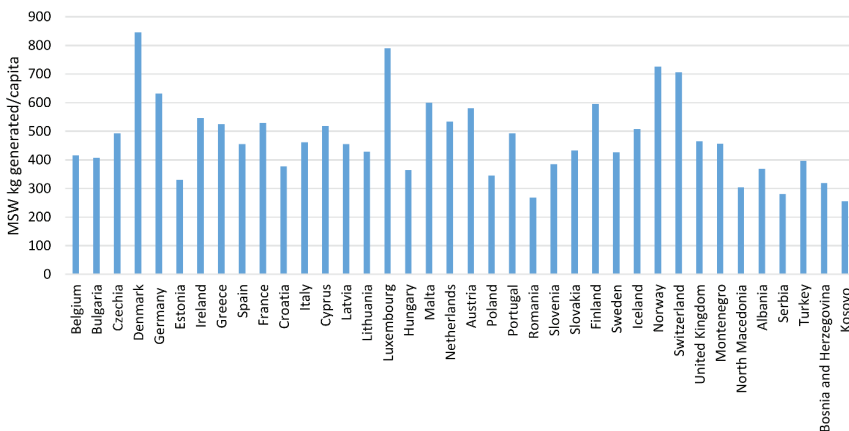


Figure 1: Annual MSW generation in Europe, kg/capita (Eurostat, 2020)



The management of solid waste has become one of the most critical environmental issues. Urgent actions are required to cope with the huge amounts of MSW and to protect from its adverse ecological impacts. The hierarchy of MSW management is presented in Figure 2. As can be seen from the figure, solid waste management hierarchy promotes waste prevention before recycling and disposal. Landfilling is the least preferred option, however it is the most commonly used waste disposal method (Zhang et al. 2019). Incineration of the MSW can be a simple option for waste disposal, however, many technical and economic obstacles inhibits its large-scale deployment in energy plants (Scarlat et al., 2015). The MSW hierarchy should consider sustainability of environment, public health and economy of the processes (Yakubu and Zhou, 2019).

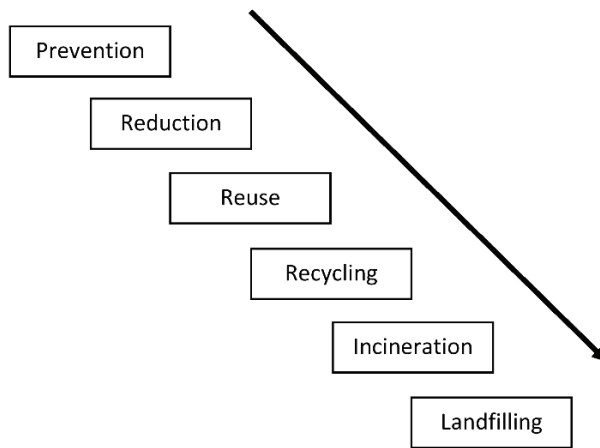


Figure 2: MSW management hierarchy (Yakubu and Zhou, 2019).

The biodegradable organic parts of MSW result in greenhouse gas (CH<sub>4</sub> and CO<sub>2</sub>) emissions to the atmosphere (Jha et al., 2008; Gutierrez-Gomez et al., 2021). Recycling and energy recovery processes could help to reduce the greenhouse gas emissions from MSW (Yi et al., 2018). Waste to energy (WtE) processing provides reduction in the waste volume, production of renewable energy and reduction in greenhouse gas release to the atmosphere. The energy produced from MSW has potential to contribute in meeting the local energy demand.

## 2. WASTE TO ENERGY CONVERSION OF MSW

Waste can be utilized through thermochemical and biochemical processes. The schematic description of waste to energy processes are shown in Figure 3. High moisture content and low heating value of MSW generally restrict its energy conversion via thermal processes (Vaish et al., 2016).

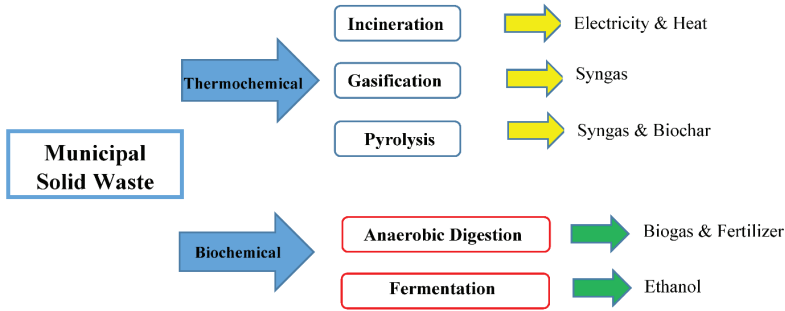


Figure 3: Thermochemical and biochemical processes for energy conversion of MSW.

Incineration is a thermochemical process where oxidation of combustible materials in the waste stream takes place. The incineration process is generally carried out at about 850 °C. Incineration reduces the volume of waste, helps to destroy the harmful species in MSW that threatens public health and produces energy (Stehlik, 2009). Incineration can pose positive effect on environment by renewable energy generation and by avoiding greenhouse gas emissions generated from landfills (Foster et al., 2021).

Gasification is a mature technology that converts waste into a clean and usable form of energy under thermal conditions. In gasification process, oxidation of MSW is carried out in a limited oxygen medium within the temperature range of 800-1000 °C. Gasification produces a combustible syngas composed mainly of methane, hydrogen, oxygen, carbon dioxide and nitrogen (Lopes et al., 2018). Operational parameters and Waste characteristics such as moisture content, gasifying agent, equivalence ratio, gasifier temperature, particle size, etc. have impact on gasification efficiency (La Villetta et al., 2017).

Pyrolysis is a well-known thermochemical process for waste disposal. It converts waste materials into energy and valuables, such as bio-oil, synthetic gas, and biochar products in an inert environment (Akyürek, 2021). It is an attractive way of extracting biomass energy to produce bio-oil which can be used in furnaces, turbines, and diesel engines as fuel or as feedstock for chemical production (Tripathy et al., 2016; Akyürek, 2019). Syngas produced in pyrolysis can be utilized for power generation. The solid product biochar can to be used as soil conditioner and green adsorbent (Turgut, 2020).

Anaerobic Digestion (AD) is a well-known process within the waste to energy technologies for organic waste treatment. It is the most widely used

methods for managing MSW is energy recovery from the organic material fraction of municipal solid waste through (Dehkordi et al., 2020, Foster et al., 2021) and collecting landfill gas (Oska et al., 2021). AD is a biological degradation process of organic matter in MSW in the absence of oxygen through a consortium of microorganisms (Derba et al., 2009) AD occurs under hydrolysis, acidogenesis, acetogenesis, and methanogenesis phases (Zamri et al., 2021).

The anaerobic digestion process produces biogas which is mainly composed of methane, carbon dioxide, hydrogen (Yentekakis and Gouda, 2017). Biogas can be upgraded to methane as natural gas substitute by purification methods. Biogas can be used as a potential energy source for renewable heat and electricity production (Akyürek, 2018; Akyürek, 2019; Tyagi et al., 2018). The amount of methane production depends on many parameters such as C/N ratio, pH, temperature, retention time, fuel mix, etc. (Samira, 2018).

*Table 1: Characteristic properties of Biogas produced from MSW (Yentekakis and Gouda, 2017).*

<b>Composition</b>	<b>Biogas</b>
CH <sub>4</sub> , Vol. %	60-70
CO <sub>2</sub> , Vol. %	30-40
N, Vol. %	< 1
H <sub>2</sub> S, ppm	10-2000
HHV, MJ/m <sup>3</sup>	21-24

Turkey is an energy importing country; therefore, every renewable energy resource option in the energy mix of the Country is of great significance. The increasing amount of MSW reveals the importance of energy production and its contribution to the economy and sustainable development. Energy conversion of MSW via biogas and landfill gas production are non-polluting, environmentally feasible and cost effective processes. In this regard, this study aims to estimate the theoretical energy generation and greenhouse gas (GHG) reduction potential of MSW through biogas production and landfill gas production in the TR-61 Region of Turkey including Antalya, Isparta and Burdur Provinces.

### **3. MATERIALS AND METHODS**

#### ***3.1 MSW Production in TR-61 Region***

Biogas gas potential can be estimated from the composition of the solid waste. The amount of the gas produced depends on the site but using empir-

ical data the rate of gas production can be determined (Osra et al., 2021). In this study, the MSW based biogas potential and their energy equivalent and carbon dioxide sequestration potential of the West Mediterranean Region (TR-61 Region) of Turkey for year 2020. The TR-61 Region consists of Antalya, Isparta and Burdur provinces.

Availability of huge amounts of MSW production in the Region offers great potential for production of green energy. In Figure 2, the annual variation in MSW amount in the Region is presented. The MSW inventory data has collected from TUIK (Turkish Statistical Institute, 2020). As can be seen from the figure, the annual production potential of MSW has shown an increasing trend in the region through the years 2010 to 2020. Among the provinces, Antalya has shown to have the highest MSW production with 82.3 % share, followed by Isparta and Burdur provinces (Figure 3). Typical waste characteristics and waste composition of the MSW are presented in Table 2 and Table 3, respectively. As can be seen from Table 3, MSW compositions is dominated by 34 % food waste.

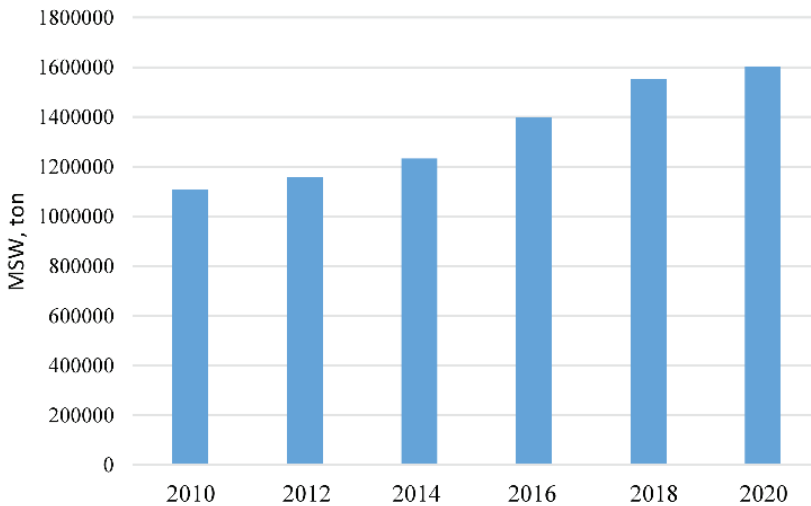


Figure 3: MSW Production of in TR-61 Region

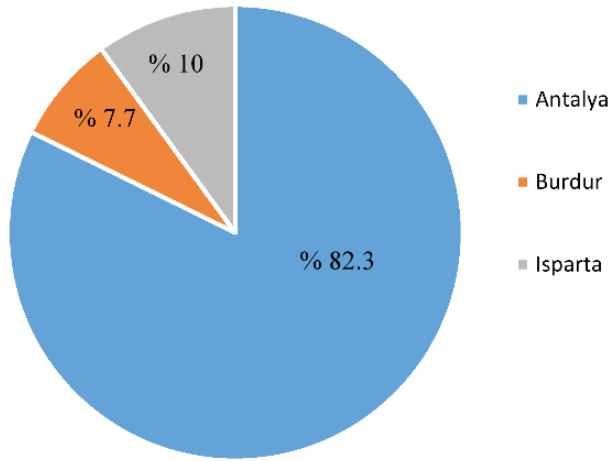


Figure 4: Share of the MSW produced in provinces of TR-61 Region, 2020.

Table 2: Characteristics of typical MSW (Foster et al., 2021)

C %	49.5
H %	5.6
N %	1.33
O %	32.4
VM %	87.1
Moisture %	34.2
TS %	29.0
VTS %	21.0
HHV, MJ/kg	18.7

Table 3: Composition of MSW in Turkey (MoSIT, 2018)

Food Waste	34 %
Paper	11 %
Cartoon	5 %
Plastics	2 %
Metal	1 %
Glass	6 %
Other Combustibles	19 %
Other Non-combustibles	22 %

### 3.2 Biogas Production

Many factors such as type of total solids ratio, volatile solids ratio, the availability ratio of waste and operating conditions have influence on the anaerobic digestion process. Excess ammonia content, high temperature and/or pH levels are some of the operational obstacles that can hinder the methane production in anaerobic digesters (Kelleher et al., 2002).

Theoretical biogas production from MSW is determined from Equation 1 (Avcioğlu and Türker, 2012):

$$TBP = M * TS \% * VTS \% * AC * EB_{VTS} \quad (1)$$

where TBP denotes the theoretical potential of biogas (m<sup>3</sup>/year),

M is the total amount of the MSW produced for a vertain year (kg/year)

TS represents the ratio of the total solids of MSW, %

VTS is the ratio of total volatile solids in the MSW, %

EBVTS is the quantity of estimated biogas produced per kg of the volatile total solids (m<sup>3</sup>/kg VTS).

### 3.3 Energy Recovery

The amount of energy produced from bio-methane (kWh/year) is calculated based on Equation 2;

$$E_M = TBP * M_p * E_{CH_4} \quad (2)$$

Where MP represents the methane production ratio of biogas %

ECH<sub>4</sub> is the energy content of methane (36 MJ/m<sup>3</sup> CH<sub>4</sub>)

Electricity generation from bio-methane is calculated from Equation 3;

$$E_{M\epsilon} = E_M * \eta \quad (3)$$

$\eta$  denotes electricity conversion of bio-methane energy depending on the power generation plant.

## 4. RESULTS AND DICUSSION

The amount of Municipal solid wastes (MSW) have been greatly increased due to rapid growth of population and urbanization. Improper disposal of the MSW results in contamination of air, soil, and underground water together with detrimental impacts on environment and public health. Hence, effective waste management solutions are needed for sustainability of the modern life.

In this study, the theoretical potential of biogas production from MSW in TR-61 Region of Turkey including Antalya, Isparta and Burdur provinces was estimated. The results revealed that the region has total 103 million m<sup>3</sup>/year biogas production potential. This is an indicative of efficient management of MSW could be further processed for energy recovery. The distribution of the biogas potential within the provinces has demonstrated in Figure 4. As can be seen from the figure, Antalya has the highest potential for biogas production.

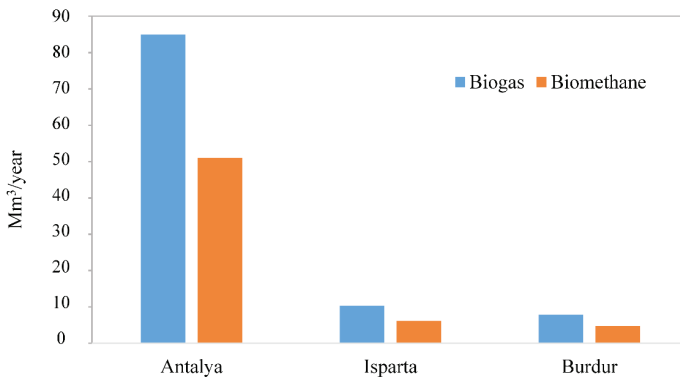
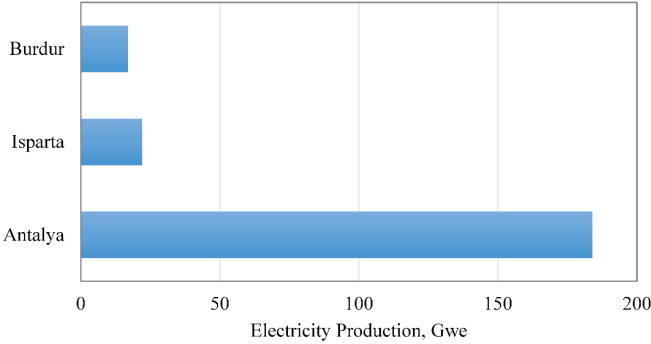


Figure 4: Biogas and biomethane potential of MSW (2020)

Waste to energy biogas production is a promising technology that has positive impacts on environment and community. Biogas application can bring multiple benefits to the local governments by the reduction of the waste volume and control of pollutant emissions to the atmosphere. Therefore, biogas production from -MSW could be considered as an effective approach for renewable energy production and environmental protection (Aftab et al., 2021). The annual energy potential of biogas produced from MSW in TR-61 Region of Turkey is about 620 GWh (Table 4). The theoretical electricity production potential in the Region is obtained as 223 GWe. The energy potential of the provinces are shown in Figure 6.

Table 4: Energy generation capacity in TR-61 Region of Turkey (2020)

Province	Energy Generation Capacity	
	TOE	MWh
Antalya	43 867	510 079
Isparta	5354	62 256
Burdur	4088	47 544
TOTAL	53 310	619 879



*Figure 5: Annual electricity generation potential of MSW*

Converting waste materials into energy is both economically profitable process by generating renewable energy from an undesired waste and environmentally beneficial by reducing greenhouse gas emissions. The energy potential of MSW in TR-61 Region of Turkey accounts for annual reduction of greenhouse gas emissions by 1.45 Mtons of CO<sub>2, eq</sub>.

## 5. CONCLUSION

Municipal solid waste is a valuable energy resource when it is properly managed and processed. Today, energy security is one of the major concern of the Nations due to depletion of fossil fuel reserves and increasing greenhouse gas emissions that threatens the sustainability of the environment. Therefore, converting MSW into energy becomes an attractive approach for renewable power generation, waste reduction and environmental protection. In this regard, this study aimed to estimate waste to energy potential of MSW in TR-61 Region of Turkey through biogas production process. The results showed that proper implementation of biogas plants for MSW can be an economical and environmentally feasible option that can provide annually 620 GWh energy production and 1.45 Mtons of carbon dioxide equivalent emission reduction in the Region. Waste to energy conversion technologies should be encouraged for achieving a sustainable environment.

## Acknowledgement

This research received no specific grants from any funding agency in public, commercial or non-profit sectors.



## REFERENCES

- Aftab MR, Zhang L, Kung CC (2021) Renewable Power Potential from Municipal Solid Waste: A Case Study in Jiangxi, China. *Econ, Soc, Tech, & Climate Change*, 1-11. <https://doi.org/10.1177/21582440211061316>
- Akyürek Z (2018) Potential of biogas energy from animal waste in the Mediterranean Region of Turkey”, *Journal of Energy Systems*, 2(4): 159-167. <https://doi.org/10.30521/jes.455325>
- Akyürek Z (2019) Sustainable Valorization of Animal Manure and Recycled Polyester: Co-pyrolysis Synergy. *Sustainability* 11(8): 2280. <https://doi.org/10.3390/su11082280>
- Akyürek Z (2019) Energy Recovery and Greenhouse Gas Emission Reduction Potential of Bio-Waste in the Mediterranean Region of Turkey, *El-Cezeri Journal of Science and Engineering*, 6 (3): 482-490. <https://doi.org/10.31202/ecjse.551780>.
- Akyürek Z (2021) Synergetic Effects during Co-Pyrolysis of Sheep Manure and Recycled Polyethylene Terephthalate. *Polymers* 13(14): 2363. <https://doi.org/10.3390/polym13142363>
- Avcioglu, AO, Türker U (2012) Status and potential of biogas energy from animal wastes in Turkey”, *Renew. Sust. Energ. Rev.*, 16: 1557–1561. <https://doi.org/10.1016/j.rser.2011.11.006>
- Coşkun S, Ozgur L, Polat O, Gungor A (2016) A model proposal for green supply chain network design based on consumer segmentation. *Journal of Cleaner Production* 110: 149-157. <https://doi.org/10.1016/j.jclepro.2015.02.063>
- Coskun S, Akgül E (2022) Sustainability Management Model Based on Risk Analysis and Implementation of the Model. *Sustainability* 14(8): 4396. <https://doi.org/10.3390/su14084396>
- Derba K, Bencheikh-lehocine M, Cecchi F, Menia AH, Pavan P (2009) Application of the IWAADM1 model to simulate anaerobic co-digestion of organic waste with waste activated sludge in mesophilic condition. *Bioresource Technology* 100 (4): 1539-1543. <https://doi.org/10.1016/j.biortech.2008.07.064>
- Dehkordi SMMN, Jahromi ARTJ, Ferdowsi A, Shumal M, Dehnavi A (2020) Investigation of biogas production potential from mechanical separated municipal solid waste as an approach for developing countries (case study: Isfahan-Iran) *Renewable and Sustainable Energy Reviews* 119: 109586. <https://doi.org/10.1016/j.rser.2019.109586>
- Eurostat (2020) Municipal Solid Waste Statistics. [https://ec.europa.eu/eurostat/statistics-explained/index.php?title=Municipal\\_waste\\_statistics](https://ec.europa.eu/eurostat/statistics-explained/index.php?title=Municipal_waste_statistics)
- Foster W, Azimov U, Gauthier-Maradei P, Molano LC, Combrinck M, Munoz J, Esteves JJ, Patino L (2021) Waste-to-energy conversion technologies in the UK: Processes and barriers– A review, 135: 11026. <https://doi.org/10.1016/j.rser.2020.110226>

- Gutierrez-Gomez AC, Gallego AG, Palacios-Bereche R, de Campos Leite JT, Neto AMP (2021) Energy recovery potential from Brazilian municipal solid waste via combustion process based on its thermochemical characterization. *Journal of Cleaner Production* 293:126145. <https://doi.org/10.1016/j.jclepro.2021.126145>
- Jha, AK, Sharma C, Singh N, Ramesh R, Purvaja R, Gupta PK (2008). Greenhouse gas emissions from municipal solid waste management in Indian mega-cities: a case study of Chennai landfill sites. *Chemosphere* 71 (4): 750-758. <https://doi.org/10.1016/j.chemosphere.2007.10.024>
- Kelleher BP, Leahy JJ, Henihan AM, O'Dwyer TF, Sutton D, Leahy MJ (2002) Advances in poultry litter disposal technology – a review”, *Bioresour. Tech.* 83: 27–36. PII: S0960-8524(01)00133-X
- La Villetta M, Costa M, Massarotti N (2017) Modelling approaches to biomass gasification: A review with emphasis on the stoichiometric method, *Renewable and Sustainable Energy Reviews*, 74: 71-88. <https://doi.org/10.1016/j.rser.2017.02.027>
- Lopes EJ, Queiroz N, Yamamoto CI, Neto PRC (2018) Evaluating the emissions from the gasification processing of municipal solid waste followed by combustion, *Waste Management*, 73: 504-10. <https://doi.org/10.1016/j.wasman.2017.12.019>
- Osra FA, Ozcan HK, Alzahrani JS, Alsoufi MS (2021) Municipal Solid Waste Characterization and Landfill Gas Generation in Kakia Landfill, Makkah. *Sustainability* 13, 1462. <https://doi.org/10.3390/su13031462>
- Scarlat N, Motola V, Dallemand JF, Monforti-Ferrario F, Mofor L, (2015) Evaluation of energy potential of Municipal Solid Waste from African urban areas. *Renewable and Sustainable Energy Reviews*, 50: 1269-1286. <https://doi.org/10.1016/j.rser.2015.05.067>
- Samira Z (2018) Evaluation of biogas potential from livestock manures and rural wastes using GIS in Iran. *Renewable Energy* 118: 351-356. <https://doi.org/10.1016/j.renene.2017.11.026>
- Stehlík P. (2009) Contribution to advances in waste-to-energy technologies. *J Clean Prod* 17(10):919–31. <https://doi.org/10.1016/j.jclepro.2009.02.011>
- Tripathi M, Sahu JN, Ganesan P (2016) Effect of Process Parameters on Production of Biochar from Biomass Waste through Pyrolysis: A Review. *Renew. Sust. Energy. Rev.* 55: 467–481. <https://doi.org/10.1016/j.rser.2015.10.122>
- Themelis NJ, Ulloa PA (2007) Methane generation in landfills. *Renew. Energy* 32: 1243-1257. <https://doi.org/10.1016/j.renene.2006.04.020>
- Turgut S (2020) Determination of Biosorbent Performance of Biochar and Magnetic Biochar Derived from Animal Manure in Arsenic Remediation from Wastewater, MSc Thesis, Burdur Mehmet Akif Ersoy University.
- Turkish Ministry of Science, Industry and Technology (MoSIT) (2018) National Recycling Action Plan.

- Tyagi VK, Fdez-Güelfo LA, Zhou Y, Alvarez-Gallego CJ, Garcia LIR, Ng WJ (2018) Anaerobic co-digestion of organic fraction of municipal solid waste (OFMSW): progress and challenges. *Renew Sustain Energy Rev* 93:380–99. <https://doi.org/10.1016/j.rser.2018.05.051>
- Turkish Statistical Institute (2020) Municipal Solid Waste Statistics. <https://tuik.gov.tr>
- Yakubu Y, Zhou J (2019) Novel approach to quantify municipal solid waste management hierarchy based on analytical hierarchy process. *International Journal of Environmental Science and Technology*, 16: 1897–1908. <https://doi.org/10.1007/s13762-018-1768-x>
- Yentekakis IV, Goula G (2017) Biogas Management: Advanced Utilization for Production of Renewable Energy and Added-value Chemicals. *Front. Environ. Sci.*, <https://doi.org/10.3389/fenvs.2017.00007>
- Yi S, Jang YC, An AK (2018) Potential for energy recovery and greenhouse gas reduction through waste-to-energy Technologies. *J. Clean. Prod.* 176: 503-511. <https://doi.org/10.1016/j.jclepro.2017.12.103>
- Vaish B, Srivastava V, Singh P, Singh A, Singh PK, Singh RP (2016) Exploring untapped energy potential of urban solid waste, *Energy, Ecology and Environment*. 1:323–342. <https://doi.org/10.1007/s40974-016-0023-x>
- World Bank (2018) *What a Waste 2.0. A Global Snapshot of Solid Waste Management to 2050*. International Bank for Reconstruction and Development/The World Bank, Washington, DC, p. 295.
- Zamri MFMA, Hasmadi S, Akhiara A, Ideris F, Shamsuddin AH, Mofijur M, Fattah MR, Mahlia TMI (2021) A comprehensive review on anaerobic digestion of organic fraction of municipal solid waste. *Renewable and Sustainable Energy Reviews*, 137: 110637. <https://doi.org/10.1016/j.rser.2020.110637>
- Zhang, C.; Guo, Y.; Wang, X.; Chen, S. (2019) Temporal and spatial variation of greenhouse gas emissions from a limited-controlled landfill site. *Environ. Int.*, 127, 387–394





## **CHAPTER 3**

### **3D PRINTERS AND APPLICATIONS**

*Erdal ÖZBAY<sup>1</sup>*

*Feyza ALTUNBEY ÖZBAY<sup>2</sup>*

---

1 Asst. Prof. Dr., Firat University, Faculty of Engineering, Computer Engineering, 23119, Elazig, Turkey, ORCID: 0000-0002-9004-4802, E-Mail: erdalozbay@firat.edu.tr

2 Asst. Prof. Dr., Firat University, Faculty of Engineering, Software Engineering, 23119, Elazig, Turkey, ORCID: 0000-0003-0629-6888, E-Mail: faltunbey@firat.edu.tr

Three-dimensional (3D) printing; although it has many different definitions, it is the conversion of an object designed in a virtual form (digital) to a solid model with layered production technique (Mpofu, Mawere, & Mukosera, 2014). In other words, it is the process of obtaining a digital model from a solid 3D object of any shape, using 3D printing or additives (“3D Printing,” 2021). Generally, in methods using solid materials, the material is placed in different shapes on each successive layer in a sequential form. Traditional 3D processing procedures rely on the material being exposed through methods such as cutting or punching, but new systems create 3D printing by sequentially adding layers to the ground. As a result, a layering process is employed, in which each layer of the model is constructed sequentially until the full item is revealed. In this regard, the 3D printing technique can achieve a one-off customizable production target from the mass production line. Any object can be produced, especially from a wide range of buildings to a small toy (Anastasiou, Tsirmpas, Rompas, Giokas, & Koutsouris, 2013).

## 1. 3D Printers

A three-dimensional printer is a machine that transforms a model into a solid model consisting of layers. The process is defined as printing, as the upwardly rising layers are formed at each point in the horizontal section by solidification of a liquid or powder, similar to the fusion of toner or ink to the paper in a printer (“3D Printing,” 2021).

The first publications on layer technology and 3D printer design date back to 1970 (“A Brief History of 3D Printing,” 2021). The first patent application for the 3D printer was the Japanese Dr. in 1981. It was made for Hideo Kodama’s rapid beam prototyping device, which works with the laser beam’s curing technology (SLA). Kodama could not complete the project due to financial problems. In 1984, Charles Hull managed to manufacture the first Stereolithography (SLA) printer. The company “3D Systems”, founded by Charles, produced the first commercial printer in 1986. In the same year, Carl Deckard from the University of Texas applied for a 3D printer patent working with another technology Selective Laser Sintering (SLS). This was followed by Scott Crump’s first Fused Deposition Modeling (FDM) 3D printer in 1989 (“All3DP,” 2022).

During the next 20 years, 3D printers continued to be used and developed in businesses. In 2005, Dr. Gordon launched the RepRap project, which aims to deliver three-dimensional printers to everyone. The project, which started with open-source software, produced the first 3D printer of Maketbot. Thus, three-dimensional printers have become more common. Today, it is becoming more common with its easy-to-use and cheap cost (“All3DP,” 2022).

In Turkey, the first printer SLA was founded by Arçelik. In 10 years, Arçelik Rapid Prototyping (RP) Laboratory has become one of Turkey's and Europe's largest laboratory, in the 2000s it was followed by companies in the jewelry industry. After 2003, 3D printers started to be used in medical applications (Negis, 2009).

3D printers were first used in the 1980s. These systems are based on the computer monitoring of a pattern usually immersed in a liquid polymer. Various objects were built by curing the plastic materials used in layers with the help of patterns followed by a laser ("What is 3D printing?," 2022). In this process, significant improvements have been made in the production of additives so that the material extrusion can be reused. A material pushed from a mechanical head, such as inkjet printers passing ink onto paper, can be used to create an object ("7 Things You Didn't Know About 3D Printing," 2013). The difficulty of reaching 3D printers and the cost of acquisition are significantly reduced with the advancement of technology. 3D printers are becoming more popular in the home, with prices starting at a few hundred dollars.

Printing 3D items, on the other hand, has a significant disadvantage in that it necessitates specialized knowledge ("3D Printing in Medicine: How Technology Will Save Your Life," 2013). Both the digital file and the final print must be created by an authorized individual. Especially in the aviation industry and automotive industry, various spare parts are produced that serve advanced economies of scale. 3D printing has caused some analysts to describe 3D printers as the second industrial revolution. Thus, the way the production line in industries has changed dramatically ("3D Printing," 2010).

In 1981, employing photopolymers from Nagoya Municipality's Industrial Research Institute, 3D printer technology for the first time provided a working fast prototyping method. Bill Clinton performed on the saxophone at The Arsenio Hall Show in 1992, and 3D Systems developed the world's first Stereolithographic apparatus (SLA) machine. Dr. Adrian Bowyer's RepRap Project, which began in 2005, is essentially an open-source attempt to produce a 3D printer that can build itself, or at least print the majority of its parts. As a result, a large number of inexperienced users have obtained access to the 3D printer's full capabilities.

Today, technology is developing rapidly. With Industry 4.0, there have been developments in many areas. Production is one of the most important areas where these developments are experienced. 3D printer technologies, which emerged in addition to traditional production methods, are rapidly developing and becoming widespread today.

3D printers can now be used at home, allowing us to produce our own designs, the parts we need, and many products. In the field of health, studies

are carried out on topics such as 3D printing technologies, artificial tissue production, and medical education. In addition to the use of 3D printers in the production of spare parts for vehicles in the automotive sector, various options are offered to the user by customizing some parts of the vehicles. In the food sector, cake and chocolate production is carried out, while in the textile field, the modeling of the clothes, the creation of patterns, and the production of the clothes are carried out. Thanks to the 3D printers used in the defense industry and aerospace fields, both spare parts are produced and advantages are obtained thanks to the durable and lightweight parts. With 3D printers, which have also taken their place in the construction sector, it is possible to build houses with faster and lower costs.

## 2. How it Works?

In order to print a three-dimensional object, you must have the digital data of that object. In other words, you have to draw your part in 3D on the computer. Or, you can scan a piece you have with three-dimensional scanners (3D-Scanners) and create 3D data on the computer and perform operations on it.

After that, after your 3D model imports the program of your 3D printer, the program slices this data into slicing layers. It produces x, y coordinates called g-code for each layer, just like in CNC machines. In addition, it adds speed information of 3D printer extruder. Then, these codes are processed and your part is formed. This method is valid only for FDM. Although there are different processing methods in 3D printers with different technology, slicing method is used in all of them.

The process of printing in 3D printers first begins with the modeling of the design. Considering the nature of the design to be made for modeling, one of the 3D design programs (Blender, Maya, Zbrush, Sketchup, Solidwork, Fusion 360, etc.) can be preferred. Another issue to be taken into consideration during modeling is the design of the model according to the characteristics of the printer technology to be used (SLA, FDM, etc.) in the style that will provide the most smooth printing (for example, avoiding supports for the FDM printer as much as possible). After the model is designed, the required format (stl and obj, etc.) is printed for the software that will produce commands for the 3D printer.

The design file is transferred to an interface program (cura, zaxe, etc.) to generate commands (G-code) that the printer can understand. With this program, after editing options such as printing material, support method, etc., slice operation is made according to the layers. With the G-code produced by the program, it regulates the movements of the printer on the axis for the FDM printers, temperature, etc. values and sends them to the printer as a command. When printing starts at the printer, the printer continues printing



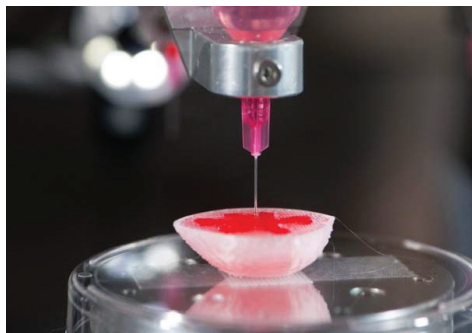
according to these commands and monitors the temperature with its sensors. In SLA printers, G-code is created by producing separate commands for each layer according to the intensity of light and curing time.

The virtual design of the object you wish to model in a design program is the first step in the 3D printing process. Figure 1 shows the design visualized in the MeshLab application, the real 3D object and its digital model. The virtual model is employed as the physical template for the digital thing that will be generated. This can be done with a 3D modeling application like Computer-Aided Design (CAD). Alternatively, a 3D scanner can be used. This scanner fulfills the task of creating a 3D digital copy of physical objects and placing them in the program to be modeled in 3D (Zukas & Zukas, 2015).



**Figure 1.** MeshLab application, real 3D object and digital model (Zukas & Zukas, 2015).

After the design step, the model is split into numerous horizontal layers in preparation for printing. This prepared file is sent to the 3D printer, which will view the object layer by layer, as illustrated in Figure 2.



**Figure 2.** Obtaining 3D Digital model layer by layer [11].

### 3. 3D Printer Technologies

There are three primary types of 3D printing technologies that are widely used. Fused Deposition Modeling (FDM), Stereolithography (SLA), and Selective Laser Sintering (SLS ) are examples of these techniques. FDM

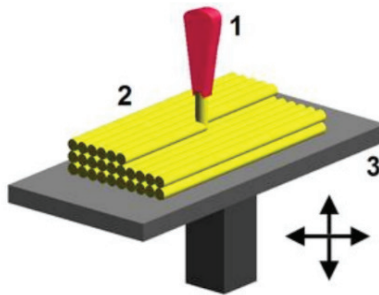
technology is the most widely used in prototype and end product productions due to its ease of use and cheapness. FDM is a form of printing based on the principle that the printers are extruded forward and the layers are heated and flowed from the tip called nozzle to knit the layers from bottom to top. By moving on nozzle x, y, and z axes utilizing slides and shafts, an object is created upwards from the table. The temperature is adjusted according to the quality of the thermoplastic by controlling the desired temperature value with the help of sensors during printing. Different types of thermoplastics can be used, as well as varieties that use metal or metal added materials (Zukas & Zukas, 2015).

Another technology is SLA technology. The solidification process called “curing” is carried out by exposing a liquid called resin in a tank to the light of various wavelengths such as laser or daylight. The designed model is transferred to the printer’s interface program in the same format, and printing is started after the intensity and time of the beam is adjusted for each layer and the G-code is generated. Daylight models are faster than laser because they emit light in each layer at the same time. While it is less preferred due to its difficulty in use and is expensive, it is used in sectors such as jewelry and dentistry, rather than high-pressure sensitivity. 3D Print Types are given below as titles.

### 3.1. Fused Deposition Modeling (FDM)

This method is one of the most used 3D Printer Technologies. It is widely used because it is a cost-effective material. It works by pouring the wire-shaped material wrapped around the coil with an extrusion nozzle that can open and close its flow. The material is melted in the nozzle, and the item is built layer by layer using Computer-Aided Manufacturing (CAM).

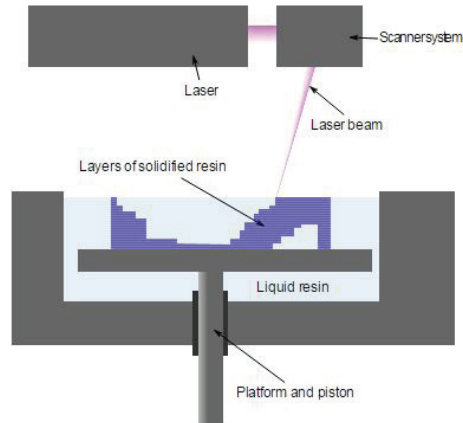
As the material hardens immediately after extrusion from the nozzle, the item is created by melt material extrusion to build layers. Acrylonitrile Butadiene Styrene (ABS) and Polylactic Acid (PLA) are the most common plastic filament materials utilized in this technology PLA. Scott Crump devised FDM in the late 1980s.



**Figure 3.** *Fused Deposition Printing (Zukas & Zukas, 2015).*

FDM is mainly used for prototyping and rapid production. It facilitates repetitive testing with the rapid prototyping method and offers a relatively inexpensive alternative that can produce fast, especially in short runs.

### 3.2. Stereolithography (SLA)



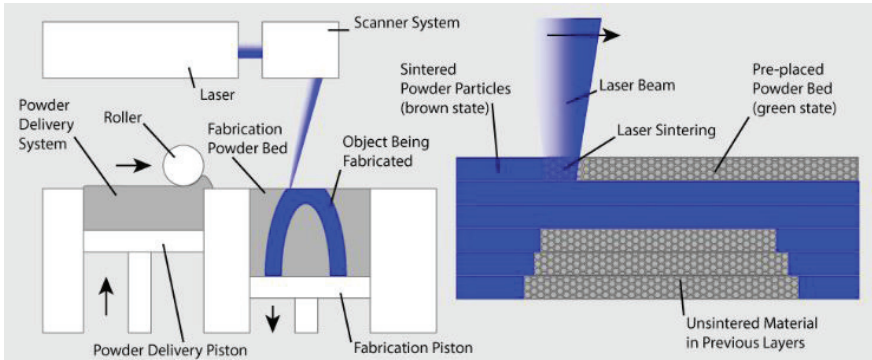
**Figure 4.** *Stereolithography Printing (Zukas & Zukas, 2015).*

SLA is the most widely used method, which involves layering an object using an ultraviolet-curable photopolymer resin and an ultraviolet laser. The laser beam follows a cross-section of the part design on the liquid resin's surface for each layer. The design traced on the resin hardens and solidifies when exposed to ultraviolet laser light, and it is joined to the layer below.

There are systems in the Stereolithography technology to secure the part to the elevator platform and avoid deflection due to gravity. A knife that can cover cross sections repeatedly and support structures that try to hold it in place to withstand lateral pressure are used. Various supports are automatically provided to prepare 3D Computer Aided Design models for use in Stereolithography machines, but they can be manipulated manually. Unlike other, less expensive fast prototyping technologies, the supports must be physically removed from the finished product.

### 3.3. Selective Laser Sintering (SLS)

Technologies for 3D Printers A high-powered laser is used in the SLS process to fuse microscopic particles of plastic, ceramic, or glass powders into a three-dimensional form mass. By scanning the sections (or layers) made by the 3D modeling application on the surface of a powdered bed, the laser selectively fuses the powdered material. The powder coating is lowered to a layer thickness after each segment is scanned. The object is then covered in a new layer of material, and the procedure is continued until the object is complete.



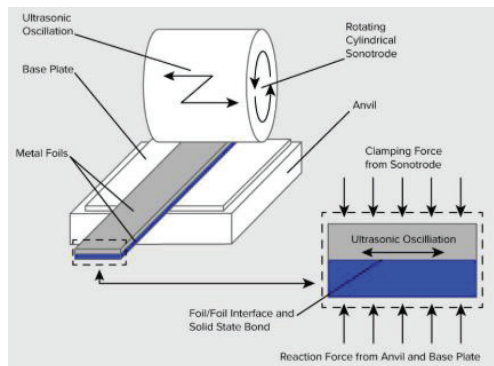
**Figure 5.** *Selective Laser Sintering Printing (“3D Printer Teknolojileri Nelerdir, Nasıl Çalışır,” 2018).*

### 3.4. Direct Metal Laser Sintering (DMLS)

DMLS is similar to SLS, but instead of plastic, ceramic, or glass, it employs metal. All unaltered particles remain unchanged and serve as a support structure for the item. As a result, no support structure is required, which is a benefit over SLS and SLA. All powders that haven’t been utilized yet can be used in the following print. Dr. SLS was a professor at the University of Texas in the mid-1980s. Carl Deckard developed and patented the technology with the help of DARPA.

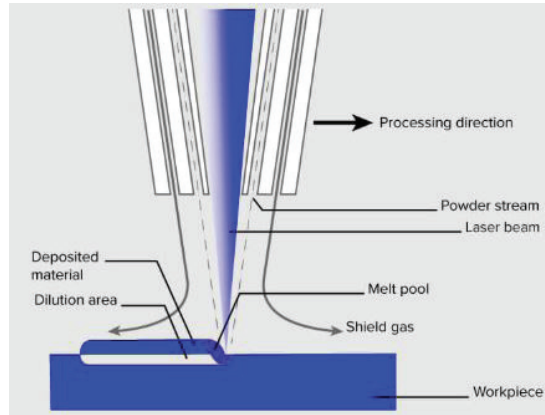
### 3.5. Sheet Lamination

The material is bound together in layers by external force in this approach. Metal, paper, or a polymer might be used for the sheets. The metal sheets are ultrasonically welded together in layers, and the CNC is then appropriately ground. Paper sheets can also be used, but the glue must be applied with glue and the edges must be carefully trimmed with delicate blades.



**Figure 6.** *Sheet Lamination Printing (“3D Printer Teknolojileri Nelerdir, Nasıl Çalışır,” 2018).*

### 3.6. Directed Energy Deposition



**Figure 7.** Directed Energy Deposition printing (“3D Printer Teknolojileri Nelerdir, Nasıl Çalışır,” 2018).

**Table 1.** All available 3D Printer types and the materials they use (Zukas & Zukas, 2015).

Type	Technologies	Materials
Extrusion	Fused Deposition Modeling (FDM)	Thermoplastics (e.g. PLA, ABS), eutectic metals, edible materials
Granular	Direct Metal Laser Sintering (DMLS)	Almost any Metal Alloy
	Electron Beam Melting (EBM)	Titanium Alloys
	Selective Heat Sintering (SHS)	Thermoplastic Powder
	Selective Laser Sintering (SLS)	Thermoplastics, Metal Powders, Ceramic Powders
	Powder bed and inkjet head 3D printing, Plaster-based 3D printing (PP)	Plaster
Laminated	Laminated Object Manufacturing (LOM)	Paper, Metal foil, Plastic film
Light Polymerized	Stereolithography (SLA)	Photopolymer
	Digital Light Processing (DLP)	Liquid resin

This method is mostly employed in the high-tech metal industry and for quick manufacture. The 3D printing system consists of a nozzle that collects surface metal powder or wire and an energy source (laser, electron beam, or plasma arc) that melts it and makes a solid object, which is commonly attached to a multi-axis robot arm. Table 1 depicts all of the different types of 3D printers and the materials they employ.

#### 4. What can be done with 3D Printers?

3D printing technology is often used in the production of new parts, in the production of fast metal and plastic prototypes, as well as in the production of final products.

The main usage areas of 3D printing technology today;

- Prototyping,
- Production of special parts,
- Production of hobby and home appliances,
- Future applications - medical (body parts), buildings and cars

3D printing is widely used in the design and prototyping process thanks to its practicality. The design, production, modification, and comparative production shorten the months-long process as it is possible within hours and weeks. Thanks to the decrease in the price of printers over the years, the use of small businesses are becoming more and more common. Besides, the use of resin molds and cast models instead of plaster tooth molds in dentistry, models produced with cast resin instead of wax models used in the jewelry industry are widely used every day (Zukas & Zukas, 2015).

3D printing has had an enormous rate of use, especially in the healthcare industry and medicine. It has been used in many fields, from making prosthetics in the bionic field to digital dental applications in dentistry. In this regard, in the field of health, every aspect of medicine has been positively affected and practices have been improved and renewed (Roopavath & Kalaskar, 2017). According to experts, the integration of 3D printing is still in exploration in many areas and predicts that it will revolutionize its use as a tool (Soto, Baez, & Sosa, 2010).

## 5. Usage Areas of 3D Printers

3D printers are used in many areas of our lives. It is used in many areas from the education sector to the health sector, from the automotive sector to the aerospace sector. Today, with the rapidly growing and widespread use of 3D printers, it is possible to produce many things that we can imagine. In this section, different usage areas of 3D printers are explained with examples.

### 5.1. Education

It has been stated by the International Technology Community that 3D printers, internet of things and gamification within the scope of science, technology, engineering and maths (STEM) will be included in educational technologies within 5 years. It is possible to use 3D printer technology in the field of education, but in order to use it correctly and efficiently, it is necessary to provide the necessary infrastructure at the point of access to qualified personnel, technical support, hardware and software. For curious, inquiring and imaginative children, 3D printing technologies are a necessary tool for ideas to come to fruition. Figure 8 shows STEM workshops for students to gain hands-on engineering experience. As a result of the use of 3D printer technologies in the education sector, students transform their ideas into concrete objects and develop their imaginations (Özsoy, Duman, & Industry, 2017).



**Figure 8.** *3D-printed parts produced by students in STEM work (“Renishaw’s STEM education programme goes virtual,” 2020).*

3D printers used in schools are a technology that increases the imagination of students and offers new learning opportunities. While this technology changes the paradigm for critical thinking, it empowers students to create physical objects that solve problems using their logic. Some schools use 3D printing technologies to create interactive, mechanical and technical lessons. This makes learning more fun by inspiring young minds. The following examples can be given to the use of 3D printing technologies in fields such as architectural education, art education, biology education, chemistry education, geology education, history education, mathematics education, science and engineering education (Kökhan & Özcan, 2018).

- Difficult subjects such as area-volume calculations, geometric shapes, functions and representation of the Cartesian system in space in the mathematics course are simplified with 3D printers.
- Engineering and design students can easily produce prototypes or parts of their projects with 3D printers.
- Architecture students can produce 3D models of their projects in a short time.
- In the biology course, students can produce organ models with 3D printers, and they can conduct detailed examinations and experiments on them.
- In the chemistry course, students can produce tangible models of molecules with a 3D printer and can easily understand their complex structures.
- In the history lesson, students can easily produce 3D models of ancient ruins on 3D printers.
- Graphic design students can bring their designs to life by producing 3D models of their work on 3D printers.



- Technical high school students can produce spare parts, modified spare parts or innovative mechanical parts with 3D printers related to their interests and projects.

Education in rapid prototyping technology fits this trend perfectly. Educational programs using 3D printers are starting to emerge in the UK. Classes are also more interesting for students and allow them to expand their knowledge not only theoretically but also practically. They have a remarkable effect on the imagination, so thanks to them, children's ideas can be turned into real projects. 3D printing technology is also more widely used in higher education. Printers are used there not only for research but also for educational purposes. It diversifies the classes by using 3D technology, which is not only a curiosity, but also becomes more attractive and expands the thematic application scope of the classes (Szulzyk-Cieplak, Duda, Sidor, & Journal, 2014).

## 5.2. Health

3D printer technologies used in the field of health are used for general product development studies, artificial tissue and organ printing, personalized surgical and medical devices, hearing aids, limb prostheses such as arm, leg, and face, as well as the production of limb prostheses such as arm, leg, and face, are widely used in dental and implant applications in the field of oral and dental health (KÜRTÜNCÜ, ARSLAN, YAYLACI, EYÜPOĞLU, & Industry, 2018). The prosthetic arm and tooth produced with 3D printer technology are shown in Figure 9.



**Figure 9.** *Prosthetic arm (Mills, 2015) and teeth (Rungrojwittayakul et al., 2020) produced with 3D printer technology*

Surgeons have the opportunity to perform operations that will achieve better results with 3D modeling and printing of human organs such as the brain and heart. By modeling the anatomically and physiologically complex organs with 3D printing technology, the anatomy of the organ is understood before the operations are performed. 3D printing technologies, which are widely used in the planning of treatments, also contribute to short and suc-



cessful operations (BESKAN, ALADAĞ, & YAPAR). In this section, the general usage purposes of 3D printers in the field of health are given (Dodziuk, 2016; EmrE, Yolcu, & Celayır, 2015).

- Production of living tissue and organs using cells as ink (bioprinting):

**Inkjet bioprinting:** In this method, tissue-engineered autologous cells are added into biological ink as droplets. The ink stored in the head called the extruder is spread in two dimensions on a heat-controlled polymerized tissue skeleton by piezoelectric or thermal energy.

**Extrusion bioprinting:** It is a contact printing method. It uses heat-controlled polymerized material for the tissue skeleton. Since it is a contact method, it damages the cells. For this reason, it is preferred for printing the acellular skeleton in tissue engineering. The substrate stored in the hood is sprayed onto the bio-skeleton by contact mechanical or pneumatic method.

**Laser bioprinting:** With the laser beams emanating from a pulsed laser source, the cell-impregnated amorphous tissue skeleton is evaporated from its edges and shaped as if a stone sculpture was carved.

- Production of orthoses, prostheses, implants with 3D printing:

The possibility of producing personalized, inexpensive implants and prostheses in a short time by using the patient's own digital images has become very popular in the fields of dentistry, orthopedics, plastic surgery, neurosurgery, thoracic surgery, and cardiac surgery and has entered into daily use. Since tooth, bone, and cartilage structures can be volumized without the need for any "fine-tuning" in computed tomography and MR imaging, rapid production can be made especially for bone and cartilage defects.

- Virtual surgical planning and radiological applications:

It is used especially in oncological surgery, trauma surgery, and reconstructive surgery in preoperative planning, resectability evaluation, operation-specific guide, demonstrative copy creation, and planning on how to repair the defects that will occur.

- Use of 3D printed models in health education:

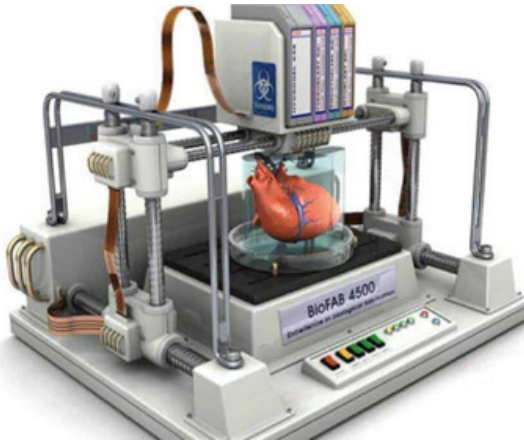
As in other fields of education, advances in computer technology and software in the field of health education increase the use of visual materials in education. While 3D digital images and animations were used frequently in education in the past, the use of real disease models produced by simulators, drawing, and volume rendering of radiological images of patients is becoming widespread in both patient, student, and assistant education.

- Surgical instrument production:

Thanks to rapid prototyping, it is possible to manufacture process-specific, low-cost and ergonomic instruments to meet the surgeon's needs. Cost, printing time and instrument durability vary according to the printing method and material used. In many centers, studies are carried out to reduce durability and cost.

- Pharmacological applications:

One of the interesting uses of 3D printers is the pharmaceutical industry. Studies in this field are mainly on the preparation of individual doses, the preparation of multilayer drugs that allow many drugs to be taken at the same time, and the conversion of drugs into homogenized forms. The drugs in the ink droplets in the bioprinter are often sprayed on a skeleton such as cellulose, bioceramic, and microporous paper with the inkjet technique. Thus, tablets with individual doses are produced with equal doses in each corner, and if multiple drugs are required to be used at the same time, they are produced layer by layer in the same tablet. Especially the elderly-forgetful, patients in nursing homes, children with difficult dose adjustments, and patients with organ failure can avoid the problems encountered.



**Figure 10.** *Artificial tissue and organ production with 3D printer technology ("3D & 4D Bioprinting Technology," 2020)*

Efficiency and effectiveness tests are carried out in medical research with tissues produced by 3D printers. In addition, it has the potential to be used in organ transplantation and regenerative medicine. Figure 10 shows artificial tissue and organ production with 3D printer technology. As a result of the studies carried out in this area, functional tissue production could not be realized due to the lack of cell seeding performance on tissue scaffolds at the desired level, mass transfer problems, and especially vascularization problems. However, mechanical properties of tissues and organs such as filtration, secretion/excretion, and pumping could be produced by modeling (Noor et al., 2019).

### 5.3. Automotive

They began to be used in many sectors with the emergence of 3D printers in the 1980s. One of these sectors is the automotive sector. Thanks to the use of 3D printers in the automotive and automotive spare parts industry, lower-cost parts production, and flexible production are provided. On average, more than 30,000 parts are put together for a vehicle. Before mass production of these parts is carried out, sample parts can be produced, necessary tests and controls can be carried out, and possible ancestors can be corrected without the production of the part in line with these tests. Thanks to 3D printer technology, bumper, grille, fender, and similar plastic parts with complex geometry can be produced with ABS filament using FDM technology (“3D Yazıcıların Otomotiv Sektöründe Kullanımı,” 2020).

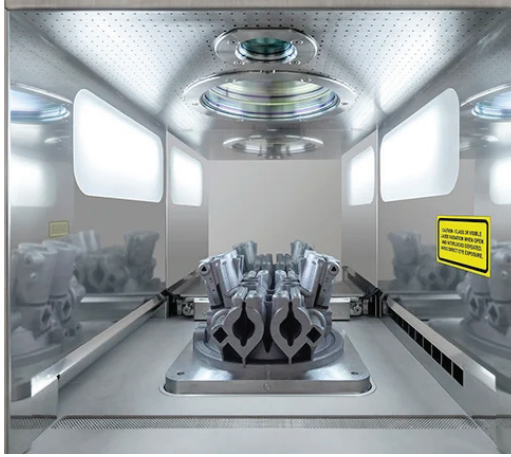
As a result of the increasing competition in the automotive sector, all brands in the sector change their production methods and make revisions to their designs in order to reduce the increasing costs. In line with all these innovations, meeting the demand is met with 3D printers (“3D Yazıcıların Otomotiv Sektöründe Kullanımı,” 2020).

The parts produced thanks to light polymers and metals used in additive manufacturing technologies show the desired performance in terms of durability and also provide an advantage in weight. The purpose of the applications in the automotive sector is actually to reduce the weight and increase the performance. This goal can be achieved through additive manufacturing. With the development of additive manufacturing technologies, polymers (such as ABS or PETG) that are resistant to automobile engine temperatures have been developed (ÖZEL, ZEREN, ALP, & Industry, 2020).

The fact that the use of 3D printers in the automotive industry is mainly associated with costs should not be forgotten. The cost of raw material waste, which occurs in a part produced with traditional production methods, is eliminated in parts produced with 3D printing technologies. In this case, both raw material waste is prevented and raw material costs are reduced. In addition to the costs, the customization of the parts and the production speed are among the other advantages (McCarthy, 2012).

At the North American International Detroit Auto Show held in 2015, “Strati”, a two-seat electric car produced using a 3D printer, was exhibited (Ichida, 2016).

Many automobile giants such as Audi, Ford, and Honda, which are important brands in the automotive sector, use 3D printers in the production of the parts of the cars they produce. In addition, some automobile brands also customize the parts they will produce upon personal request (“Otomotiv Alanında 3d Baskı Kullanımı,” 2019).



**Figure 11.** *Metal parts production with 3D printer (“Metal Milestones in 3D Printing,” 2020)*

It is also possible to produce metal alloy materials in the production methods of 3D printer technologies. AlSi10Mg, Ti64, and StainlessSteel 316L materials are frequently used in the automotive industry. The production of metal automobile parts with a 3D printer is shown in Figure 11. When production costs are compared, it is seen that 3D printer technologies are more advantageous than traditional methods (“3D Yazıcıların Otomotiv Sektöründe Kullanımı,” 2020).

#### **5.4. Aerospace**

3D printing technology is an important area in aviation. An example of this is the acquisition of Morris Technologies, an expert in additive manufacturing, by GE Aviation, which produces aircraft engines in the field of aviation, in 2012. Morris Technologies company plans to produce some parts of the Leap engine developed by CFM company in 3D printers (Kara & Magazine, 2013).

One of the most important advantages of 3D printer technology is that it becomes possible to print parts with complex surface geometry. If a 3D drawing of a part can be performed in the computer environment, without exception, that part can be divided into layers in the slicing program and production can be carried out by adding the product in layers. With 3D printers, not only plastic parts are produced, but also metal parts are produced as a result of the developments made in recent years. For example, materials such as 316L and 17-4PH stainless steel, Al-Si-a0 and Al-Si-12 aluminum alloys, H12 tool steel, titanium CP, Ti6a14V, and Ti6A17Nb titanium alloys, cobalt-chrome (ASTM75), 718 and 625 Incolene Renishaw company using these materials has produced metal parts. As a result of the observations,

it has been seen that the post-heat treatment properties of the parts using Ti6Al4V and Inconel 718 are higher than the parts produced by the forging method. Metal-based layered production technology has started to be used in the field of the aerospace industry. In this technology, powders of metals such as stainless steel such as Ti6Al4V, TiCP, 17-4, 316L melted with the help of a laser are used. Aircraft bodies and engine manufacturers use this technology to produce complex parts (Kara & Magazine, 2013).

Aircraft parts are geometrically very difficult parts. Recently, light composite parts have begun to replace heavy metals in the manufacture of aircraft. In addition, several tons of titanium are still used in the manufacture of small passenger aircraft. Most of these produced parts are produced by the machining method. During this production, 90% of the material used is cut and thrown away. Jet engine produced with 3d printing technology is shown in Figure 12. Thanks to the 3D printer technology, the material consumption in machining is prevented, thus saving energy and giving less damage to the environment (Kara & Magazine, 2013).



**Figure 12.** Jet engine produced with 3D printing technology (*"This Tiny 3D Printed Jet Engine Could Have Big Promise,"* 2021)

Additive manufacturing is more advantageous than the prices of parts used in casting, forging, and machining, which is expensive due to time, competent staff, and the high amount of scrap material in the aviation industry. In addition, the need for molds for parts is reduced, sometimes even not needed at all, thus increasing the speed of development of new parts. Additive manufacturing is seen as a potential solution for spare parts. Aircraft are often used for longer than their predicted life and spare parts for aircraft are important these parts are complex, time-consuming, and expensive. In case of need, the production of the needed part will take a long time due to the possibility that the spare part will be discontinued, and in this case, the aircraft will remain on the ground. One of the parameters that determine the performance of vehicles used in aviation is weight. That's why weight

is a critical point in the manufacture of an airplane. For example, a 1 kg reduction in the weight of the parts that make up a passenger plane will save approximately \$3,000 per year in fuel. In addition, there will be a decrease in carbon dioxide emissions (Kara & Magazine, 2013).

## 5.5. Food

One of the fundamental and revolutionary applications of 3D printing is to move the food industry into the digital age. The application of this technology allows for fast automated and repeatable processes, freedom of design, as well as great and easy variability of the cooking process that can be customized for each region or person. The use of robotic layer-based food printing systems allows the digitization and storage of the recipe of the food to prepare high-quality meals that can be repeated many times without operator error. In addition, the shape and decoration of the dish can be personalized according to the customer or occasion. Choc Edge company markets the world's first commercial 3D chocolate printer called Choc Creator. Various nozzles are used to produce melted chocolate by transforming it into the desired pattern and shape. Although it is seen as expensive for home use with a price of \$3500, it can be successful for use in niche stores tailored to specific customers and events (Gebhardt & Fateri, 2013).

In food production, 3D printers can be used to meet the demand for food design and personalized food. Different processes are applied according to the materials used for the food to be produced (Godoi, Prakash, & Bhandari, 2016).

In addition to providing food production with 3D printers used in the field of food, structural features are added to the produced foods and even it becomes possible to increase their nutritional content. Its use in the food industry is becoming widespread, especially for customized products. In food products produced using 3D printers, some additives are used to keep their shape intact. The most widely used of these additives are transglutaminase and xanthan gum. Printing materials used in the food industry are divided into two groups according to their printability. Materials such as cheese, hummus, and chocolate in hydrogel structure that can be extruded properly from the injector are examples of printable materials. In addition, a mixture of sugar, starch, and mashed potatoes as powder material was also tested in 3D printers. Successful results were also obtained in the tests made with pasta dough. Complete control over the taste, nutritional value, and texture of foods made with materials that can be printed naturally in 3D printers can be achieved. In addition to these, although there are products such as meat, rice, fruit, and vegetables that cannot be printed by nature, this situation is likely to be overcome because Aleph Farms company has produced cutlets for the first time in the world using animal cells with the 3D bioprinting technology



they have developed. In order to have a similar taste to the cutlets produced, tissues were taken from the beef part of the cow and transformed into animal cells using incubators in the laboratory environment. 4 different animal cells were obtained and these cells were made ready for use in a bio 3D printer. Regarding the chops they produce, the company used the expression, “Chop chops have a muscle structure and fat ratio similar to killed cows and are at least as soft and delicious as the meat you buy from the markets” (Aldanmaz & Sever, 2017; “Dünyada İlk Kez Biyo 3D Yazıcı Kullanılarak Pirzola Üretildi,” 2021).

## 5.6. Textile

3D printers are used for two purposes in the field of textiles. Firstly, the whole of the garment can be produced by this method, and secondly, alternative connection shapes and surfaces can be obtained from the surfaces formed by weaving or knitting, which are seen as the basis. Today, there are many types of 3D printers used in commercial areas. There are examples made with printers with FDM, SLS, and Polijet technology used in the field of fashion and textiles (YILDIRAN, 2016).

3D printers are used in the fashion industry to produce and develop prototypes, Haute couture works, and customizable products. Nike has produced the lightweight plates used in the Vapor Laser Talon and Vapor Hight Agility cleats using SLS technology, one of the 3D printing technologies. As a result of trials and tests, it was seen that there were some problems, and they redesigned the geometry of the lock and plate in response to these problems. Nike has reduced the prototyping and final production time with 3D printers from two to three months to six months (Vanderploeg, Lee, Mamp, & Education, 2017).

3D printers are used for two purposes in the field of textiles. Firstly, the whole of the garment can be produced by this method, and secondly, alternative surfaces can be obtained with different connection shapes as an alternative to the surfaces formed by weaving or knitting, which are seen as the basis. Today, there are many types of 3D printers used in commercial areas. There are examples made with printers with FDM, SLS, and Polijet technology used in the field of fashion and textile (Düzgün, ÇETİNKAYA, & Industry, 2019).

In traditional clothing production, the preparation of patterns and samples is a time-consuming process. Thanks to 3D printing technology, flexibility is provided in fashion and textile materials. Another advantage of producing clothes with 3D printer technology is that there is no need for a factory or workshop for the production of clothes. Scanning the bodies of the models during the design phase of the garment, it ensures that the garment is full to

the body. In the design process, the human body is first scanned and a 3D mold is made without arms or legs. After this stage, a model is created that can be output in 3D in the most suitable mold. The real human body is used when performing the scans. Generally, these scans collect data using four human bodies. An exemplary model is created with the measurement values made over 30 points on the human body. In order to obtain the mold, the human body is scanned 360 degrees. The first pattern is taken for a standing person, and then alternate drawings are created for sitting, running, or other movements. In the later stages, other parts of the body are created and the designer creates the elements of the garment on the computer from these parts. Due to the limited output areas of the printers, the sizes and areas of the parts to be obtained must be well planned. In addition, considering that the materials used are of a certain thickness (150mm x 150mm and 2mm thick), it is necessary to calculate the outputs in line with these dimensions (YILDIRAN, 2016).

### **5.7. Building**

Today, there are many innovations and developments in the construction industry. One of these developments is the development of printers capable of large-scale 3D printing. Thanks to this technology, which is also used in the building industry, 3D concrete printing is advantageous in terms of both cost and speed. It offers great freedom in terms of both architectural and structural design. In 3D printers using the additive manufacturing method, the material is stacked layer by layer to create the 3D model. The efficiency in costs and the advantage in production speed provide great benefits for the consumer and the contractor (Deksi, 2016).

Buildings can be constructed quickly and efficiently with 3D printers. Thanks to 3D printers, engineers can make designs with difficult geometries so that the structure to be built will be safer and stronger (Sakin & Kiroglu, 2017).

Companies like Shanghai WinSun have started using 3D printers to construct low-rise buildings in recent years. They built the rural villa and the 5-story residential block with 3D printers. Company managers stated that as a result of this experiment, the construction material used was reduced by 60% and the time by 30% compared to the traditional method. In addition, they predict that the workforce of the construction team will decrease by five times, and accordingly, the risks of work accidents and injuries will decrease (Shatomaya, Chislova, Drozdetskaya, & Ptušina, 2017).

3D printers are generally used to reduce material requirements, produce special objects, reduce labor and create rapid prototyping. With the use of 3D printers in the construction industry, it is possible to reduce the amount

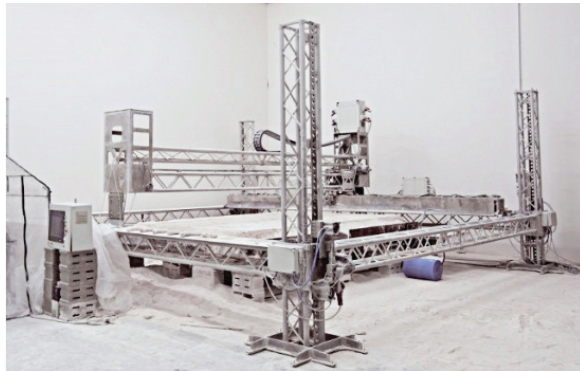


of material to be transported to the construction site, construct unique buildings, reduce the number of workers required, and construct buildings in a shorter time (Kreiger, MacAllister, Wilhoit, & Case, 2015).

Some of the work done in this area:

- The first full-scale 3D construction project is “Canal House”.
- The first residential project with an area of 298.5 m<sup>2</sup>, built with 3D printer technology, is “Yaroslav!” in Russia.
- The Institute of Advanced Architecture Catalonia undertook the design and construction of the world's first 3D printed pedestrian bridge.
- The first office hotel in accordance with official regulations was built by 3D Printhuset in Copenhagen (Özalp, Yılmaz, & Yaşar).

With the use of 3D printers in the construction industry, printers that can print from the smallest part to the entire building have been developed. Each of these printers has been used in different areas in different periods and as a result of the studies, it has contributed to many developments in the use of 3D printers in the construction industry. Figure 13 shows a house built with a 3D printer. The materials and technologies they use are different.



**Figure 13.** *Building a house using D-Shape ("Building a house with a 3D printer," 2021)*

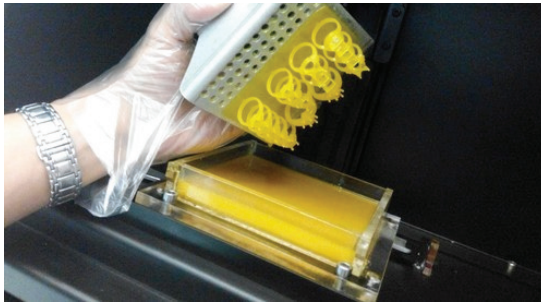
Dini, the inventor of the D-Shape 3D printer, received a patent for his work in 2009. In this study, it produced a cheaper raw material that does not harm the environment. It mainly used sand, oxide, and chlorides obtained from seawater in the components of the raw material it produces. In the solutions of materials used for 3D printing of building components, various composite materials are experimented with. It is argued that one of these materials is sulfur concrete. The mixture is heated above the melting point of sulfur. After the mixture cools down to 140 0C, it reaches the desired strength without hardening for a long time like normal concrete. For this reason, sulfurous concrete can be considered a potential building material (FELEK & Industry).

## 5.8. Jewelry

Rapid prototyping technologies have an important place in the jewelry industry. Due to the high competition in this field, which was founded on handcraft, technology has outstripped handcraft in the sector. If we compare the 3D manufacturing method used in the field of jewelry with traditional methods.

- Thanks to additive manufacturing, the accuracy rate between the design of the product and the product produced is higher.
- Time-saving thanks to additive manufacturing.
- It allows the production of unique and special designs at a low cost.
- Since it allows the production of designs with complex surface geometry, it frees the designer.
- Since it allows the user to be present during the design and production stages, it also increases customer satisfaction.

The production of complex forms with geometrical structures, which cannot be produced in physical forms, becomes possible with rapid prototyping technologies. In the classical method, it is not possible to copy the jewelry that requires manual work or is complicated due to its geometric structure, and these models can be easily produced thanks to rapid prototyping. Rapid prototyping technologies are used directly or indirectly in the jewelry industry. SLS and SLM technologies are rapid prototyping methods used in direct production. FDM, SLA, and MJM technologies are rapid prototyping methods used indirectly in production (Kiraz, SEZER, Şahin, & Industry, 2018). Figure 14 shows a 3D printer application used in jewelry.



**Figure 14.** *3D printer applications in jewelry ("DLP 3D Printer for Jewellery," 2022)*

## 6. Advantages of 3D Printing

3D Printing is a method that separates the 3D model into layers. Each layer consists of 0.1 mm thick plates. The created plates are boiled on top of each other and the model is created. In this respect, it differs from sawdust manufacturing by cutting and milling a block. Not only does it leave waste

behind, it also provides flexibility and creativity in production. Also, since 3D printing is suitable for small quantities, it can produce more economical solutions compared to plastic injection technology. It allows the change of the product produced only with the change to be made without the need for mold. Another advantage is that it can produce models that are difficult or impossible to manufacture with other production methods. In this respect, it offers designers flexibility and creativity beyond limits.

## 7. 3D Printer Costs

Although the cost issue varies according to the technology, the devices found in the cheapest market have FDM technology. You can find it at a price such as \$ 100 or you can find it on devices that have features like double extruder more sensitive to \$ 2000. Or if you want, you can take the pieces and assemble them yourself. In addition, devices that can output metal with SLS technology are around \$ million.

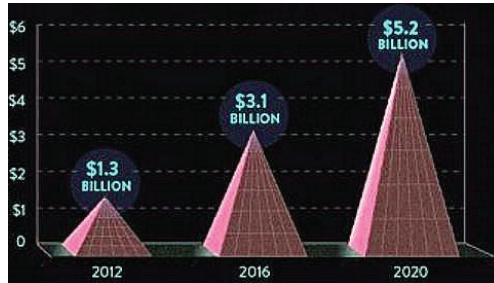


Figure 15. 3D Printer Global Market fees by years (“3D Printer Teknolojileri Nelerdir, Nasıl Çalışır,” 2018).

## 8. Applications of 3D Printing

3D printing technology has been used in a wide range of industries. Electronics, automotive, medical, architectural, aerospace, education, and other sectors, as well as series production, are all examples of 3D printing applications. Although it was used primarily for rapid prototyping, it is also widely used for rapid manufacturing.

As the production in the automotive sector is high, the 3D printer sector is not dominant yet. Thanks to the developing technology, manufacturers prefer to use 3D printer technologies in automobile designs. Because, investment cost (mold, apparatus, automation, etc.) is high when it comes to mass production. Thanks to the 3D printer, the desired product can be produced on-site at any time. In addition, it is a great advantage that it is recyclable in terms of the material used.

Since there is no production in the aviation industry, 3D printers are more dominant in this sector. In particular, parts produced from titanium ma-

terial are produced cheaper with this method. Therefore, 3D printer device manufacturers follow this sector more closely.

There are examples of usage as a concept in construction sectors. The walls are built by flowing the liquid concrete from the layer nozzle like in the FDM technology. In this way, the interior and exterior walls of a house can be created within 24 hours.

Architects have been using 3D printer devices frequently recently. A 3D printer is a quick and low-cost alternative for architects who need to present their work as a physical scale model. 3D printers help reduce manpower and time while visualizing customers' designs.

It is also frequently used in the accessories and jewelry industry. You can print and try the product you designed in minutes to see how an accessory design will look in your hand.

We also come across this technology used as bio-printing in the health sector. Biotechnology businesses and academics have investigated whether they may be employed in tissue engineering applications where ink-jet techniques are used to build organs and body parts.

In the culinary sector, restaurants like Food Ink and Melisse use it as a unique selling factor to attract clients from all over the world. The fashion industry is also seeing wearable 3D printing clothes. The sole of the Adidas Futurecraft 4D is 3D printed. Many shoe designers use 3D printers to print the shoes they developed. As a result, 3D printer technology is becoming more and more widespread, although it takes its place in many sectors in our lives. With rapidly developing technologies and innovations brought by these technologies, our lives are made easier and we keep up with these technologies. As a matter of fact, not keeping up with this digital transformation and not taking advantage of the advantages it brings is unthinkable for both individuals and businesses.

## REFERENCES

- 3D & 4D Bioprinting Technology. (2020). Retrieved from <https://serendemir.medium.com/3d-4d-bioprinting-technology-98b20066900e>
- 3D Printer Teknolojileri Nelerdir, Nasıl Çalışır. (2018). Retrieved from <http://www.kaizen40.com/3d-printer-teknolojileri-nelerdir/>
- 3D Printing. (2010). Retrieved from <http://www.forbes.com/sites/davidnicholson/2014/05/30/3d-printing-approaching-critical-mass-in-an-8-billion-industry>
- 3D Printing. (2021). Retrieved from <https://www.britannica.com/technology/3D-printing>
- 3D Printing in Medicine: How Technology Will Save Your Life. (2013). Retrieved from <https://www.cgtrader.com/blog/3d-printing-in-medicine-how-technology-will-save-your-life>
- 3D Yazıcıların Otomotiv Sektöründe Kullanımı. (2020). Retrieved from <https://www.tridi.co/blog/3d-yazicilarin-otomotiv-sektorunde-kullanimi>
- 7 Things You Didn't Know About 3D Printing. (2013). Retrieved from <https://mashable.com/2013/12/03/3d-printing-brandspeak>
- Aldanmaz, E. A., & Sever, R. J. A. B. K., Aksaray Üniversitesi, Aksaray. (2017). Gidaların dizaynında 3 boyutlu yazıcı teknolojisi uygulamaları.
- All3DP. (2022). Retrieved from <https://all3dp.com/2/history-of-3d-printing-when-was-3d-printing-invented/>
- Anastasiou, A., Tsimpas, C., Rompas, A., Giokas, K., & Koutsouris, D. (2013). *3D printing: Basic concepts mathematics and technologies*. Paper presented at the 13th IEEE International Conference on BioInformatics and BioEngineering.
- BESKAN, U., ALADAĞ, S., & YAPAR, E. A. 3B YAZICI TEKNOLOJİSİNİN SAĞLIK ALANINDAKİ UYGULAMALARI.
- A Brief History of 3D Printing. (2021). Retrieved from <https://www.cadcrowd.com/blog/a-brief-history-of-3d-printing/>
- Building a house with a 3D printer. (2021). Retrieved from <https://moohii.com/blog/d-shape>
- Deksi, A. J. Y. Y. L. T., İstanbul Aydın Üniversitesi Mimarlık Anabilim Dalı, Mimarlık Programı. (2016). Olağanüstü Durumlarda Barınma İçin Yenilikçi Bir Yaklaşım Önerisi: 3D Yazıcı İle Uygulama.
- DLP 3D Printer for Jewellery. (2022). Retrieved from <https://www.indiamart.com/proddetail/dlp-3d-printer-for-jewellery-12833481655.html>
- Dodziuk, H. J. K. i. t. p. j. o. c.-t. s. (2016). Applications of 3D printing in health-care. *13(3)*, 283.

- Dünyada İlk Kez Biyo 3D Yazıcı Kullanılarak Pirzola Üretildi. (2021). Retrieved from <https://www.webteknolojileri.com/biyo-3d-yazici-ile-uretilen-pirzola-h106145.html>
- Düzgün, D. E., ÇETİNKAYA, K. J. I. J. o. D. P. T., & Industry, D. (2019). MODA ALANINDA 3 BOYUTLU BASKI TEKNOLOJİLERİ KULLANIMI. 3(1), 19-31.
- EmrE, Ş., Yolcu, M. B., & Celayır, S. J. Ç. C. D. (2015). Üç boyutlu yazıcılar ve çocuk cerrahisi. 29(3), 77-82.
- FELEK, S. Ö. J. I. J. o. D. P. T., & Industry, D. MİMARİ YAPILARDA 3 BOYUTLU YAZICILARIN KULLANIMI. 3(3), 289-296.
- Gebhardt, A., & Fateri, M. (2013). *3D printing and its applications*. Paper presented at the RTEjournal-Forum für Rapid Technologie.
- Godoi, F. C., Prakash, S., & Bhandari, B. R. J. J. o. F. E. (2016). 3d printing technologies applied for food design: Status and prospects. 179, 44-54.
- Ichida, Y. J. I. S. (2016). Current Status of 3D Printer Use among Automotive Suppliers: Can 3D Printed-parts Replace Cast Parts. 5, 69-82.
- Kara, N. J. E., & Magazine, t. M. (2013). Havacilikta katmanli imalat teknolojisinin kullanimi. (636).
- Kiraz, C., SEZER, H. K., Şahin, İ. J. I. J. o. D. P. T., & Industry, D. (2018). Kuyumculuk sektöründe 3b baski tasarim özgürlüğünden faydalanmaya ilişkin bir perspektif. 2(2), 46-58.
- Kökhan, S., & Özcan, U. J. B. E. S. v. T. D. (2018). 3D yazıcıların eğitimde kullanımını. 2(1), 80-85.
- Kreiger, M. A., MacAllister, B. A., Wilhoit, J. M., & Case, M. P. (2015). *The current state of 3D printing for use in construction*. Paper presented at the The Proceedings of the 2015 Conference on Autonomous and Robotic Construction of Infrastructure. Ames. Iowa.
- KÜRTÜNCÜ, M., ARSLAN, N., YAYLACI, B., EYÜPOĞLU, N. J. I. J. o. D. P. T., & Industry, D. (2018). SAĞLIKTA GELİŞEN TEKNOLOJİ: ÜÇ BOYUTLU YAZICILAR. 2(2), 99-110.
- McCarthy, K. (2012). Improving rapid prototyping through the installment of 3D printers in automotive companies.
- Metal Milestones in 3D Printing. (2020). Retrieved from <https://www.sme.org/technologies/articles/2020/march/metal-milestones-in-3d-printing/>
- Mills, D. J. o. (2015). Future Medicine: The Impact of 3D Printing. J Nanomater Mol Nanotechnol 4: 3. 3, 2.
- Mpofu, T. P., Mawere, C., & Mukosera, M. (2014). The impact and application of 3D printing technology.
- Negis, E. (2009). *A short history and applications of 3D printing technologies in Turkey*. Paper presented at the US-TURKEY Workshop On Rapid Technol-

ogies, September.

- Noor, N., Shapira, A., Edri, R., Gal, I., Wertheim, L., & Dvir, T. J. A. s. (2019). 3D printing of personalized thick and perfusable cardiac patches and hearts. *6(11)*, 1900344.
- Otomotiv Alanında 3d Baskı Kullanımı. (2019). Retrieved from <https://www.3dbaskıkitasarim.com/otomotiv-alaninda-3d-kullanimi>
- Özalp, F., Yılmaz, H. D., & Yaşar, Ş. 3D YAZICI TEKNOLOJİSİNE UYGUN SÜRDÜRÜLEBİLİR VE YENİLİKÇİ BETONLARIN GELİŞTİRİLMESİ.
- ÖZEL, Ş., ZEREN, M., ALP, N. Ç. J. I. J. o. D. P. T., & Industry, D. (2020). 3D YAZICILAR İLE KATMANLI İMALAT TEKNOLOJİSİNİN OTOMOTİV ENDÜSTRİSİNDE UYGULANMASI. *4(1)*, 18-31.
- Özsoy, K., Duman, B. J. I. J. o. D. P. T., & Industry, D. (2017). EKLEMELİ İMALAT (3 BOYUTLU BASKI) TEKNOLOJİLERİNİN EĞİTİMDE KULLANILABİLİRLİĞİ. *1(1)*, 36-48.
- Renishaw's STEM education programme goes virtual. (2020). Retrieved from <https://www.renishaw.com/en/renishaws-stem-education-programme-goes-virtual-45661>
- Roopavath, U. K., & Kalaskar, D. M. (2017). Introduction to 3D printing in medicine. In *3D printing in medicine* (pp. 1-20): Elsevier.
- Rungrojwittayakul, O., Kan, J. Y., Shiozaki, K., Swamidass, R. S., Goodacre, B. J., Goodacre, C. J., & Lozada, J. L. J. J. o. P. (2020). Accuracy of 3D printed models created by two technologies of printers with different designs of model base. *29(2)*, 124-128.
- Sakin, M., & Kiroglu, Y. C. J. E. P. (2017). 3D Printing of Buildings: Construction of the Sustainable Houses of the Future by BIM. *134*, 702-711.
- Shatornaya, A., Chislova, M., Drozdetskaya, M., & Ptuhina, I. J. S. s. U. n. Z. i. S. (2017). Efficiency of 3D printers in Civil Engineering. *(9)*, 22-30.
- Soto, E., Baez, O., & Sosa, S. (2010). *Modeling, design and construction of articulated hand for use in prosthetics, with adaptive control in neural networks based on mathematical model for finger*. Paper presented at the 2010 Ninth Mexican International Conference on Artificial Intelligence.
- Szulzyk-Cieplak, J., Duda, A., Sidor, B. J. A. i. S., & Journal, T. R. (2014). 3D printers—new possibilities in education. *8(24)*, 96–101.
- This Tiny 3D Printed Jet Engine Could Have Big Promise. (2021). Retrieved from <https://infocastinc.com/market-insights/tiny-3d-printed-jet-engine/>
- Vanderploeg, A., Lee, S.-E., Mamp, M. J. I. J. o. F. D., Technology, & Education. (2017). The application of 3D printing technology in the fashion industry. *10(2)*, 170-179.
- What is 3D printing? (2022). Retrieved from <https://3dprinting.com/>
- YILDIRAN, M. J. A.-e. S. D. (2016). Moda giyim sektöründe üç boyutlu yazıcılarla

tasarım ve üretim. 9(17), 155-172.

Zukas, V., & Zukas, J. A. (2015). *An introduction to 3D printing*: First Edition Design Pub.





## ***CHAPTER 4***

### **ANALYZING EFFECTS OF DIMENSIONS OF SUSTAINABILITY ON HUMANITARIAN LOGISTICS**

*Batin Latif AYLAK<sup>1</sup>*

---

<sup>1</sup> Assistant Professor, Turkish-German University, Faculty of Engineering,  
Department of Industrial Engineering, İstanbul, Türkiye, [batin.latif@tau.edu.tr](mailto:batin.latif@tau.edu.tr)  
Orcid ID: 0000-0003-0067-1835

## Introduction

Humanitarian Logistics is a broad term that deals with the procedures and systems that involve the mobilization of resources, expertise, and people for helping vulnerable communities. Humanitarian action is associated with giving protection to civilians and ensuring the facilitation of shelter, health services, food and water provision. Therefore, different constraints of humanitarian logistics result in response to both human-made disasters as well as natural made disasters. The impact is scrutiny and concern development by the governmental sector, global humanitarian organizations, policymakers and the public. It has been observed that almost 80% of an investment which is associated with disaster relief has been channeled for logistics operations. The estimation shows that approximately 35% of the funds that are associated to logistics associated to that of logistics gets wasted because of constraints associated with humanitarian logistics which includes effort duplication, lack of response to crisis associated with human resources, reduced financial support from potential donors, and hindrance in the efficient response to dealing with requirements of beneficiaries in case of occurrence of a disaster. The United Nations Office for the Coordination of Humanitarian Affairs (OCHA) asked for logistics support funds from the international community for supporting the global relief by getting funds of \$400 million. In contrast to that request, the funding made for the logistics support was only \$213 million for supporting logistics operations (Baffoe. B. O. K. et al., 2020).

The major role of humanitarian organizations is mitigation of suffering of those beneficiaries who are not having food, shelter, and health care. This objective has led attention of such organizations toward environmental sustainability, which is not limited to the region but rather stretches to the global level and focuses on complex humanitarian supply chains (HSCs) (Wichaisri S. et al., 2017). The humanitarian organizations have been responding to such types of threats by ensuring the provision of shelter food and health care to affected populations which are considered to be beneficiaries. Moreover, humanitarian organizations have been working together for the development of agencies and contribution to the societies in long term by having an engagement in different activities associated with disaster response such as reconstructing after the occurrence of disasters and providing relief development and rehabilitation (Zarei M. H. et al., 2019).

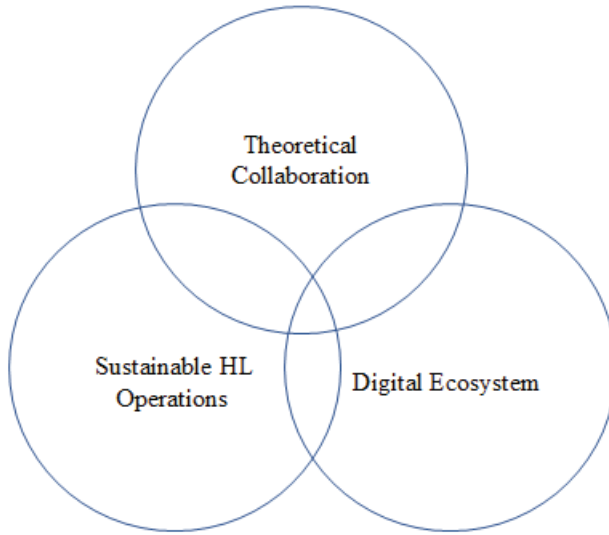
This research is organized into different sections. The first section is an introduction. The second section is a literature review in which the effects of sustainability on humanitarian logistics have been analyzed. The third section defines the methodology in which the methodology is proposed, and the cause and effects have been analyzed. Moreover, the theoretical framework has been developed and the impact of the proposed framework is realized.

The fourth section provides results and discussion related to the practical and theoretical implications of the findings. The last section is the conclusion section.

## **Literature Review**

Different researchers have worked on the sustainability of the environment in humanitarian logistics (HL). The study carried out by (Laguna L. S. et al., 2019) emphasized on the fact that the sustainability of an environment in terms of HL is considered to be a grant in terms of making decisions for which the sustainable framework was developed that would support the planning of HSC. The related factor to HSC is supply chain configuration (SSC) which is structured by different organizations. SSC deals with the development of the structure of organizations working in the supply chain sector, the relation among them and locations, the information flow and the products, and performance of logistic operations including transportation and management of inventory. The research covers the aspect of integrating SCC and environmental sustainability in commercial supply change which ranges from the problem of the location to the designing of the product, development of strategic design and closed-loop designing of supply chain system (Sreekumar V., 2018).

The conceptual framework has been defined by (Baffoe. B. O. K. et al., 2020), which axiological view as the sustainable framework tool for the development of a hybrid humanitarian business logistics system. The framework involves theoretical collaboration, defining HL and monitoring and the sustainability in its operations and implementation of technological tools to ensure sustainable growth in demands during the occurrence of disaster operations at the global level by having a digital business ecosystem. Figure 1 shows conceptual framework for the development of HL.



*Figure 1 Conceptual framework for the development of HL based Digital Business Ecosystem (Baffoe. B. O. K. et al., 2020)*

The increase in humanitarian issues on annual basis results in the occurrence of conflicts, prompting of natural disasters and implementation of preparative measures for saving assets and lives. The logistics prove to be the key element in providing relief to humanitarian operations while taking up huge funds for allocating alleviation. The HL aid workers have been facing challenges such as having reduced support from donors, availability of information, concerns related to coordination and transparency issues. This can be listed by the effect that different countries in the Middle East having conflict issues have been facing relief challenges because of reduced funds for supporting logistics movements related to supplies as well as securities of affected areas. Moreover, effort duplication, coordination issues related to logistics and reduced donor support were observed in the ocean tsunami in India in 2004, the earthquake in Haiti in 2010, the typhoon in Haiyan in 2013, and the earthquake in Nepal in 2015 all of which required worth looking for better future (Besiou M. et al., 2018).

For the improvement of logistics, standardization is necessary. The biggest challenge associated with humanitarian logistics is lacking the standards. It has been observed that the identification of research gaps in HL as well as management of supply chain results in the improvement of interoperability of the operations associated with HL. The framework developed for standards is divided into two main categories which are physical standards and organizational standards (Paciarotti C. et al., 2021). Similarly, the standards for operation in emergency conditions were observed, which also focused on information technology and training. the relation of standardization

with training and information technology was made to illustrate the fact that unawareness in IT and HSC results in an inefficient outcome, and overlap by humanitarian actors and organizations in their actions and applications (Ye Y. et al., 2020). The standards are provided in Table 1.

*Table 1 Classification of Logistics Standards (Paciarotti C. et al., 2021)*

<b>Standards</b>	<b>Services</b>	<b>Standards of Organizations</b>
Standardization of product	Service	Standardization of services
Standardization of packaging	Human resources	Training related to standardization
Standard relief item		Standardizing the language
Standardization of kits		Common standards for skill development
Selection of relieving products while maintaining standards		
Equipment standardization		The setting of standards and skills based on community
Standardization of infrastructure for management of commodity	Information systems	Development of standard structure for information
		Providing basic logistic information while maintaining standards
Warehouse standardization		Communication and sharing protocols
Standardization of telecommunication		Maintenance of track entries standard
		Standardizing information system
	Measurement of performance	Performance measurement and matrices using standard indicators
		Utilization of standard systems
		Maintenance of accountability standards
	Procedures practices, tools and processes	Standardization of operating procedures and process standards
		Standardization of humanitarian practices
		Standardization of quality
		Standardization of recruitment while considering ethics

All the standards and services are insured effectively when the transparency is maintained. what is required in the whole procedure is transparency in information sharing. The transparency ensures the achievement of accountability and increment of public trust in such organizations. The stakeholders, organizations and government demand efficiency, a high level of performance and effectiveness in humanitarian operations. The efficient HL operation results in the utilization of a minimum level of resource distribution till the last miles and satisfaction of victims. Whereas the effectiveness will measure the requirements of affectees or victims, resources to be utilized, trust-building flexible operation disclosure and innovations (Baffoe. B. O. K. et al., 2020).

Three main characteristics of the logistic services were developed by (Hirata E., 2019). The three most important variables which are essential for the achievement of customer satisfaction are associated with digitalization of the logistics operations, maintenance of quality and skills of personnel and staff working at organizations, and insurance of customer quality services. However, the coordination issues among the government, organizations and stakeholders are essential and can not achieve all the three characteristics without proper monitoring, audit and management (Sandra C. et al., 2018). When it comes to government, the authorities realize that NGOs is unable to deal with natural disasters without having the assistance of stakeholders (Fathalikhani et al., 2019).

## Methodology

The literature review shows that lack of the research on environmental sustainability associated with HL. Therefore, it is necessary to observe the causes having negatively impacted the environmental sustainability associated with HSCs. Additionally, the impact of SSC on the environmental sustainability of HSC has to be realized. The steps of this methodology are provided in the Figure 2.

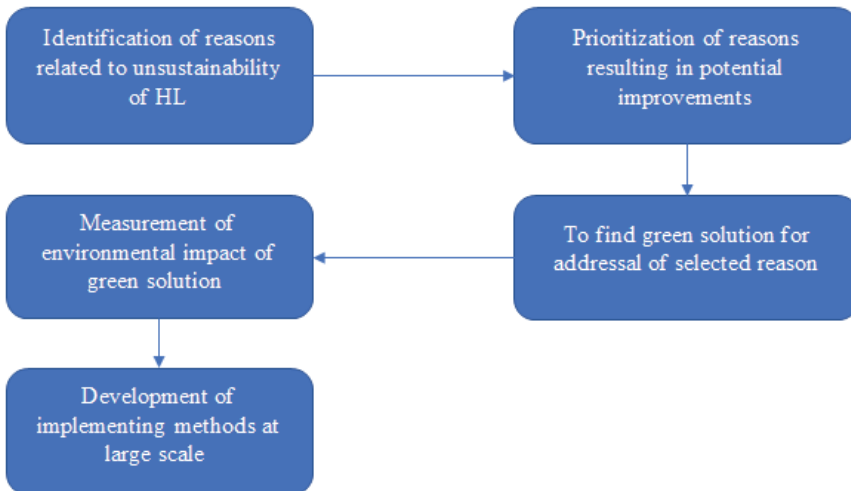


Figure 2 Proposing mixed method research (Zarei M. H. et al., 2019)

The research makes utilization of mixed methods research is a methodology which was defined by (Johnson et al., 2007) according to which “the type of research in which a researcher or team of researchers combines elements of quantitative and qualitative research approaches (e.g., issues of qualitative and quantitative viewpoints, data collection, analysis, interference techniques) for the broad purpose of breadth and depth of understanding and cooperation”.

## Cause and Effect diagram

The cause-and-effect diagram containing causes has been provided below for the identification as well as visualization of causes of problems and their effects. Figure 3 shows observation of cause and effects.

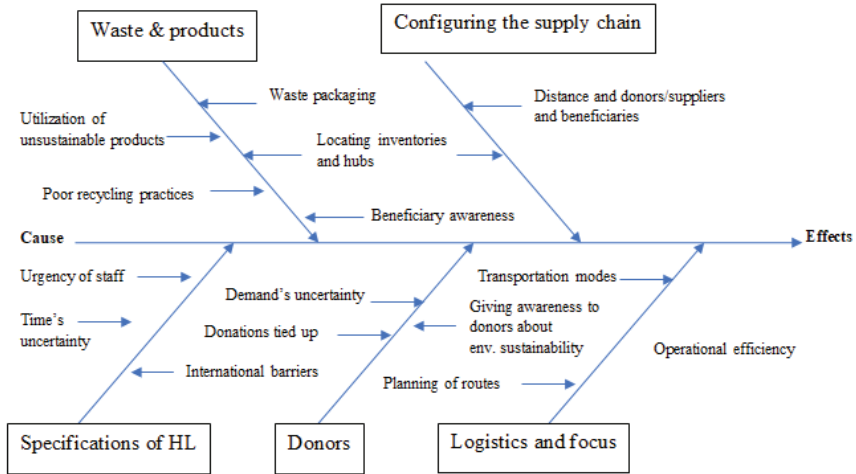


Figure 3 Observation of Cause and Effects

In a practical world scenario, the management of systems is considered to be different when compared to the management of their commercial counterparts. The main reason behind such differences is the variation of characteristics of demand. The commercial supply chains are based on forecasting techniques of demand based on a push production system or are initiated by the customer based on a full production system. In contrast to that, the humanitarian logistics are quite uncertain due to the intensity of disaster, location of disaster and timing of disaster, and the consequences unknown exact requirements to provide relief to the beneficiaries. Therefore, the attributes are provided (Nikabakhsh et al., 2011) below:

1. The objectives of nonprofit organizations are quite different (assurance of speedy as well as a lifesaving response rather than maximization of profits and reduction of costs) from conventional organizations that are focused on making profits.
2. Complications in the objectives increases because of the intervention of different entities such as governments donors, stakeholders, relief organizations and beneficiaries
3. Complexity in characteristics of demand may consist
  - a. Uncertainty in the features of demand such as quantity, location, type and time
  - b. Sudden occurrence of demand and shorter times for leading
  - c. Access to high stakes along with adequacy and delivery at a time

4. Complexity in operations increases which may be due to
  - a. Chaotic nature of an event after the occurrence of a disaster
  - b. Reduced resources such as medical supplies, equipment and vehicles
  - c. Professional and experience lacked by HR
  - d. Security lacks
5. Coordination among the organizations and their participation in relief operations may often lack
6. Involvement of politics in an environment hinders the humanitarian operations and their maintenance
7. The rules and regulations have not been devised for ineffective organizational behavior related to humanitarian logistics systems. The people being affected (until they are not dead) have no claim greater than their damages which get paid by government and insurance organizations. However, in the case of commercial supply chains, inefficient members will be paying for their inefficiencies.

### **Theoretical formulation of a Framework**

Based on the above factors the framework has to be formulated which must deal with

1. Big data analytics
2. Ecosystem platform
3. Law and governance
4. Crowdsourcing or outsourcing
5. Standardization
6. Investment and sustainability monitoring
7. Trust, transparency, information sharing, accountability and risk management

### **Big Data Analytics**

Big data analytics illustrates a positive impact or effect on HL as well as logistics operations at commercial scales. The strategic decision has to be taken for which the data has to be acquired which will be related to supply chains without having borders, autonomous vehicles transformation of business conduct while utilization of logistics operations and supply chain management, predictive analytics, and additive manufacturing (Rau H. et al., 2019). For this purpose, the data will be obtained from different resources which may include social media, the Global Positioning System, pattern preferences of customer buying and planning of resources by enterprises (Govindan K. et al., 2018).



## **Ecosystem Platform**

It is associated with cooperation between numerous actors of HSC ensuring a hybrid loop of opportunities as well as benefits that can be obtained from each other while carrying out humanitarian come business logistics. in spite of several ecosystems related to industry actions, businesses, and other sectors (Tsujimoto M. et al., 2018) made the addition of a multi-factor networking system to make a room for the creation of values for themselves. Therefore, a concept has been facilitated for merging different models of operations while considering the life-saving activities and making profits through humanitarian activities and business logistics. Therefore, the framework will be consisting of an ecosystem platform.

## **Law and Governance**

The lessons have been learned by the implementation of ecosystem platforms in the health industry, and Switzerland has got success in giving health care services to the patients by providing them with an electronic health record-based platform. The example shows that the ecosystem platform is helpful in eliminating the plication in efforts and information, operational optimization cost reduction and encouragement of information and communication technology (Pietro D. C. et al., 2018). However, without having legislative support all these factors neither can be considered nor can be met in an efficient way. Therefore, countries have been governing all these factors through government regimes public management and bureaucracy. Now, international laws, national laws at the country level and private as well as domestic laws have been governing the regulations associated with the HL which are applied to both business entities and non-business entities (Bugge M. et al., 2019).

## **Crowdsourcing or Outsourcing**

The response to challenges associated with meeting the demands of beneficiaries as well as consumers in both complex environments and dynamic environments prompts the firms and organizations for outsourcing their functions and operations to get stable solutions. In HL settings, the uncertainty in the achievement of adequate transport systems, logistics, and outsourcing capacity of an HR are different methods utilized by the HL actors who may require guidance from volunteers, service providers, organizations, military, and logistics regiments for providing the logistics services and meeting the transport demands of the users (Pollok P. et al., 2019).

## **Standardization**

The standards help in carrying out social economic and technological development while focusing on innovations and making the products smart.

Standards defined by governments private organizations and other groups ensure that the user will be enjoying the product, which will be relying on the solution will be provided by the manufacturer at the same time. different standardization bodies including International Organization for Standardization, (ISO), International Electrotechnical Commission (IEC), American National Standards Institute (ANSI) and other such organizations have been working on the reservation of interests of different groups and users while ensuring the satisfactory and efficient operations as well as conduct being obeyed at local and international levels. The logistics service providers and actors, donors and other organizations help in promoting the sustainability of HL. All the operations when executed while following the common standards will result in HL sustainability (Blind K. et al., 2018).

### **Investment and sustainability monitoring**

The United Nations has defined the importance of sustainability by incorporating humanitarian operations to the reduction of causalities and deaths during disasters. In addition to that, a long-term vision is that the sustainability efforts are put for the mitigation of disaster response, and improvement in terms of socio-economic perspective by the involvement of stakeholders in HL operations (Li c. et al., 2019).

### **Trust, transparency, information sharing, accountability, and risk management**

When the collaboration is made among the partners and organizations, the resource sharing as well as information in small, medium, and large enterprises is mandatory for creating value, risk management and protection (Ghita D. L., 2019). It is the duty of HL operators and actors to ensure transparency and accountability for meeting the humanitarian principles (Kreindler S. A. et al., 2019).

Based on above-mentioned factors, the developed framework is shown in Figure 4.

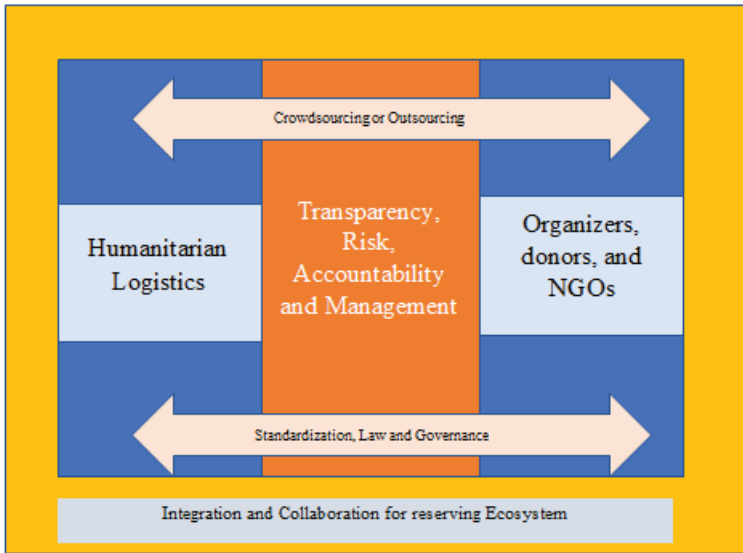
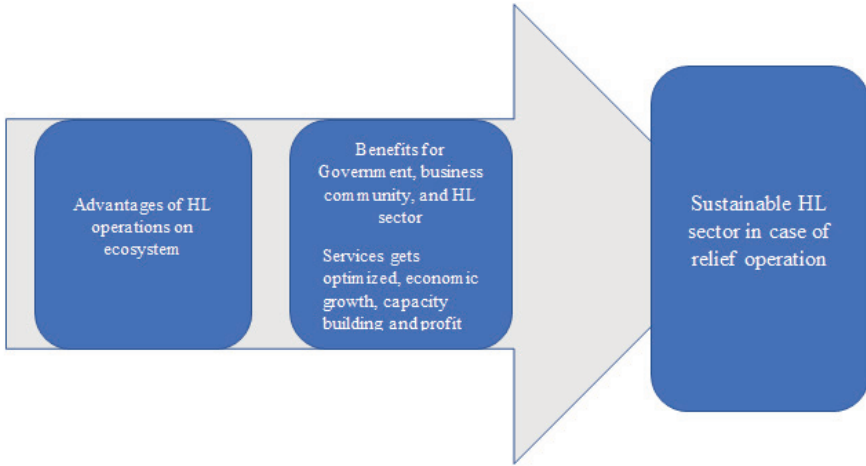


Figure 4 Proposing a framework

## Results and Discussion

After the careful analysis of different factors associated with HL, the framework has been proposed which ensures that the logistics operations are properly monitored and sustainable humanitarian endeavors. In addition to the challenges related to HL support, the framework developed will be helpful in diverting the attention to that self-resilience and self-reliance through the utilization of such schemes. The development and maintenance of such a framework will be resulting in the development of an ecosystem which will be dependent on analytics of data at an enhanced level. Therefore, partnerships with tech giants such as NASA, Google, Amazon, IBM and organizations like Gates Foundations will be kept in place. Such an ecosystem will be helpful in carrying out efficient HL operations. Lastly, the collaboration of the business section and HL will bring benefits to the zones and regions which have got affected by the disasters. Moreover, the third world countries will get the knowledge from such a framework which will boost their HL trends. However, the requirement will be the development of infrastructure which will be a challenging task. Some countries like Afghanistan, South Sudan and Yemen have been facing such issues that are more specifically associated with disasters and security concerns. The impact of the proposed framework has been provided which is shown in Figure 5.



*Figure 5 Impact of the designed framework*

## Conclusions

The humanitarian activities being associated with social reforms and the promotion of human welfare suffers because of different disasters associated with natural and human activities. The governments, organizations, stakeholders and business community play their roles in such situations. They ensure that the shelter, food and health care requirements of affectees are fulfilled. However, the hindrances associated with such activities result in reduction of efficiency in operations and meeting the demands of affectees. Therefore, a cause-and-effect diagram has been made to illustrate the causes which affect the operation of HSCs and HL. To deal with such a situation, a framework has been proposed which considers laws and governance, standardization, crowdsourcing and maintenance of transparency, accountancy and risk management. The impact has been realized which ensures business growth for stakeholders and the ecosystem while ensuring sustainable HL operation and relief for affectees.

## REFERENCES

- Baffoe. B. O. K. et al. (2020). Humanitarian Relief Sustainability: A Framework for Humanitarian Logistics Digital Business Ecosystem. *Transportation Research Procedia*, 48, 363-387. doi:10.1016/j.trpro.2020.08.032
- Besiou M. et al. (2018). OR applied to humanitarian operations. *European Journal of Operational Research*, 269(2), 397-405. doi:https://doi.org/10.1016/j.ejor.2018.02.046
- Blind K. et al. (2018). Publishing, patenting, and standardization: Motives and barriers of scientists. *Research Policy*, 47(7), 1185-1197. doi:https://doi.org/10.1016/j.respol.2018.03.011
- Bugge M. et al. (2019). Governance for system optimization and system change: The case of urban waste. *Research Policy*, 48(4), 4076-1090. doi:https://doi.org/10.1016/j.respol.2018.10.013
- Fathalikhani et al. (2019). Government intervention on cooperation, competition, and cooptation of humanitarian supply chains. *ocio-economic Planning Sciences*, 69(100715). doi:https://doi.org/10.1016/j.seps.2019.05.006
- Ghita D. L. (2019). Reconceptualizing the paradox of openness: How solvers navigate sharing-protecting tensions in crowdsourcing. *Research Policy*, 48, 1323-1339. doi:https://doi.org/10.1016/j.respol.2019.01.013
- Govindan K. et al. (2018). Big data analytics and application for logistics and supply chain management. *Transportation Research Part E: Logistics and Transportation Review*, 114, 343-349. doi:https://doi.org/10.1016/j.tre.2018.03.011
- Hirata E. (2019). Service characteristics and customer satisfaction in the container liner shipping industry. *The Asian Journal of Shipping and Logistics*, 35(1), 24-29. doi:https://doi.org/10.1016/j.ajsl.2019.03.004
- Johnson et al. (2007). Toward a Definition of Mixed Methods Research. *Sage Journals*. doi:https://doi.org/10.1177%2F1558689806298224
- Kreindler S. A. et al. (2019). Primary care reform in Manitoba, Canada, 2011–15: Balancing accountability and acceptability. *Health Policy*, 123(6), 532-537. doi:https://doi.org/10.1016/j.healthpol.2019.03.014
- Laguna L. S. et al. (2019). A multicriteria Master Planning DSS for a sustainable humanitarian supply chain. *Annals of Operations Research*, 283, 1303-1434. doi:https://doi.org/10.1007/s10479-018-2882-3
- Li c. et al. (2019). Organizational coordination in sustainable humanitarian supply chain: An evolutionary game approach. *Journal of Cleaner Production*, 291-303. doi:https://doi.org/10.1016/j.jclepro.2019.01.233
- Nikabakhsh et al. (2011). 15 - Humanitarian Logistics Planning in Disaster Relief Operations. In *Logistics Operations and Management* (pp. 291-332). Elsevier. doi:https://doi.org/10.1016/B978-0-12-385202-1.00015-3
- Paciarotti C. et al. (2021). Humanitarian logistics and supply chain standards. Liter-

ature review and view from practice. *Journal of Humanitarian Logistics and Supply Chain Management*, 3, 550-573.

- Pietro D. C. et al. (2018). E-health in Switzerland: The laborious adoption of the federal law on electronic health records (EHR) and health information exchange (HIE) networks. *Health Policy*, 122(2), 69-74. doi:<https://doi.org/10.1016/j.healthpol.2017.11.005>
- Pollok P. et al. (2019). Attracting solutions in crowdsourcing contests: The role of knowledge distance, identity disclosure, and seeker status. *Research Policy*, 48(1), 98-114. doi:<https://doi.org/10.1016/j.respol.2018.07.022>
- Rau H. et al. (2019). From invisibility to impact: Recognising the scientific and societal relevance of interdisciplinary sustainability research. *Research Policy*, 47(1), 266-276. doi:<https://doi.org/10.1016/j.respol.2017.11.005>
- Sandra C. et al. (2018). The role of humanitarian agencies in reconstruction and development of disaster affected communities in Japan and the Philippines. *Procedia Engineering*, 212, 606-613. doi:<https://doi.org/10.1016/j.pro-eng.2018.01.078>
- Sreekumar V. (2018). Supply chain strategy decisions for sustainable development using an integrated multi-criteria decision-making approach. *Sustainable Development*. doi:<https://doi.org/10.1002/sd.1861>
- Tsujimoto M. et al. (2018). A review of the ecosystem concept — Towards coherent ecosystem design. *Technological Forecasting and Social Change*, 136, 49-58. doi:<https://doi.org/10.1016/j.techfore.2017.06.032>
- Wichaisri S. et al. (2017). Trends and Future Directions in Sustainable Development. *Sustainable Development*. doi:<https://doi.org/10.1002/sd.1687>
- Ye Y. et al. (2020). Managing Relief Inventories Responding to Natural Disasters: Gaps Between Practice and Literature. *Production and Operations Management, Production and Operations Management Society*, 29(4), 807-832. doi:[10.1111/poms.13136](https://doi.org/10.1111/poms.13136)
- Zarei M. H. et al. (2019). On the role of regional hubs in the environmental sustainability of humanitarian supply chains. *Sustainable Development*, 1-14. doi:<https://doi.org/10.1002/sd.1945>



***CHAPTER 5***

**SUBJECTIVE WEAR TRIALS OF  
SPORTSWEAR**

*Esra Taştan Özkan<sup>1</sup>*

---

<sup>1</sup> Assist. Prof. Dr., Bitlis Eren University, Faculty of Fine Arts, Department of Traditional Turkish Arts, Bitlis , Turkey, e-mail: etastan@beu.edu.tr. (ORCID: 0000-0001-8950-6048)

## 1.1. Introduction

Sportswear is a product which we use during activity or when we want to feel comfortable in daily life. According to the statement made by the Sporting Goods Manufacturers Association, sportswear is defined as clothing purchased for use in active sportswear (Newber, 2009). Sportswear includes clothes used in outdoor conditions such as mountaineering and skiing, as well as T-shirts used in daily wear, clothes used in team sports such as football, and clothes that provide a certain pressure used in fitness. One of the most important topics in the sportswear industry is product renewals. The global market of sportswear is expected to climb from \$97 billion in 2015 to \$178 billion in 2019 (Url-1). While the sales size of sportswear was 160.61 million dollars in 2020, due to the effect of the COVID 19 pandemic, it could not achieve the expected growth according to the results of the analysis made in 2017-2019, and sales rates decreased by 10.6% in 2020. As a result of the decline in the pandemic, this value is expected to reach 267.61 billion dollars in 2028 from 170.94 billion dollars in 2021 (Url-2). The features expected from sportswear are versatility, performance, comfort and fashion. In this study, especially the comfort features of sportswear were emphasized and a detailed examination was made on wear trials, which is one of the thermal comfort measurement methods in dynamic conditions.

Comfort is a difficult term to define and some researchers defined it as being in a harmony with the thermal environment. There are different components of comfort, including tactile, thermal and physical comfort. Tactile comfort occurs by the contact of the fabric surface with the skin and the warning of sensory receptors on or near the skin surface. Therefore, the structure of the fabric surface, the type of fiber used and the fiber properties have a significant effect on the sensations experienced. One of the most important comfort parameters is thermal comfort because it ensures the survival of the person depending on the surrounding conditions. Generally, it is desired that winter clothes have high thermal comfort properties, which means high thermal resistance values. On the other hand, summer clothes are preferred with low thermal resistance value to throw away excess heat and moisture from the human skin. Physical or body motion comfort concepts related to the way the garment fits the body and allows body movement. Especially for athletes, it is a desired parameter that the physical comfort properties of the clothing they wear should be high. There are many ways to measure clothing thermal comfort in the wear situation. The first of these is to make wear trials and the other is to measure the thermal comfort properties of the clothes using a thermal manikin system. Detailed information will be given about the evaluation of sportswear by the wear trial method in this chapter.



## 1.2. Sport Garment and Comfort

Depending on the activity level of the person and the climatic conditions, the expectations of the sporters from the sports clothes also change. It is desirable that the thermal resistance and water vapour resistance of the clothes to be used in hot climatic conditions should be low. The reason for this is that the clothes make the person feel cool and it is possible to throw excess heat outside by perspiration. Because, during activity, especially in high temperature environments, the skin temperature of the people increases and after a certain point they need perspiration. Sportswear to be used in activities performed in cold climatic conditions must have high thermal resistance properties. These garments must also have a certain water vapour resistance value. Because even in cold weather conditions, people need sweating if they are active. If this sweat is not removed from the body, it accumulates in the layer between the skin and the clothing called microclimate and disturbs the person. So, the water vapour resistance of the clothes to be used under these conditions should not be too low. Because this situation causes the garment to lose too much heat. Slater defined comfort as the expression of psychological, physiological, neurophysiological and physical harmony between people and their environment and divided comfort into three headings (Slater, 1985). In this study, comfort was divided into three categories like tactile, thermal and physical comfort which are described below.

### 1.2.1. Tactile Comfort

Tactile comfort is a very important factor in clothing comfort. Because clothing is in direct contact with the human body, it is in continuous and dynamic interaction with the body in the case of clothing. This interaction includes thermal, mechanical and visual perceptions and is called tactile comfort.

Tactile comfort is the sense of comfort which is related to the responses of the nerve endings to outer stimulants such as heat, pressure and pain. These sensations are operated by the brain and transformed into sensory subjective perceptions. Thus, appropriate responses are given to these signals by regulating the blood flow rate, sweating rate and heat generation.

As the garment touch the skin, the garment handling characteristics affect the sensory comfort. Various psychological sensations such as hardness, softness, hot-cold, hot-cool, and wet-dry are perceived by the skin. Neurophysiology researchers stated that different sensations arising from the fabric-skin interaction can be classified into three categories. These; are pain, warmth and tactile sensations. During the fabric-skin interaction, the fabric puts pressure on the skin and stimulates the touch receptors by sending vibrations. Kawabata and Niwa (1996) divided the fabric handle into three

levels in their study. These; are mechanical properties, initial handle value and total handle value. According to ASTM D123 (2003), some concepts used when defining fabric handle properties were given in below:

- Flexibility
- Compressibility
- Elongation
- Density
- Surface friction
- Thermal properties.

***Fabric Prickle:*** It is the most disturbing feeling in the clothes worn on the skin surface. It varies from person to person depending on the wearing situation. When the person is exposed to this feeling for a long time, this discomfort causes itching. In particular, underwear made of wool causes itching and skin discomfort.

***Fabric Itch:*** Similar to a prickle sensation, it also occurs conclusion of the activation of some surface pain receptors. The presence of perception of itching in clothing is associated with the presence of perception of prickling. Li (1988), itching sensation; fiber diameter is related to fiber thickness at high and low pressure and fabric surface roughness.

***Fabric Roughness:*** Mechanical interaction of fabric and skin during contact, friction, hardness and roughness are the main factors that cause itching. These are influential factors in determining the tactile sensations of clothing that touches the skin. A garment that feels comfortable in a low humidity environment can cause a feeling of discomfort in a high humidity environment. Fabric stiffness and roughness relate to many objectively measurable physical properties. For example, hardness; friction, sinking, tearing and bending rigidity, thickness and area density.

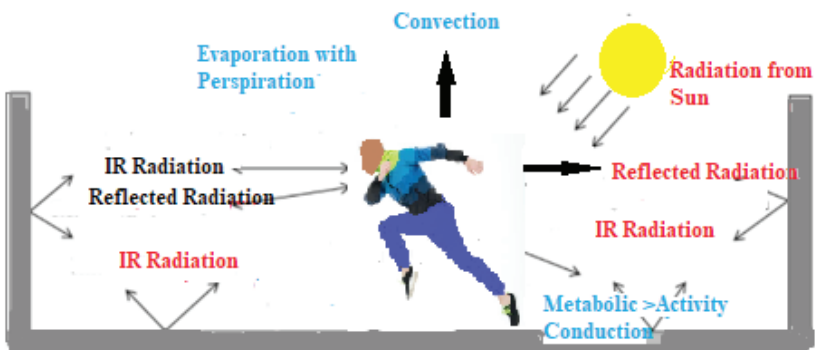
The most important perception that causes discomfort in clothes is the feeling of prickling and tingling. This feeling, caused by the fiber ends coming out of the fabric surface, manifests itself in the form of pain in the nerve endings. A diagram of the tingling sensation is given in Figure 1.



**Figure 1.** Representation of the tingling sensation caused by the fabric on the skin surface

### 1.2.2. Thermal Comfort

Thermal comfort is one of the crucial factors when designing a cloth. Because a clothing system fits one climatic condition may not be fit for another climatic condition. Clothes help maintain the thermal balance of the human body in different climatic conditions and provide a sense of comfort from heat reduction, skin temperature, air movement, and moisture on the body. Environmental conditions include ambient air temperature, relative air velocity and water vapour pressure. For example, expectations from a garment used in summer are that it can rapidly throw away sweat and its thermal resistance value must be low. Expectations from a winter garment are that it has a high thermal resistance value and it can make the person feel comfortable even in very cold climatic conditions. The figure of heat transfer from an athlete to the environment was given in Figure 2.



**Figure 2.** Heat transfer from an athlete to the environment

The human body is often not subjected to constant conditions, but rather to changing environment, clothing and activity conditions. The heat change between the body and the environment is significantly influenced by the dynamic responses of the garment. Thermal comfort of a garment system under dynamic conditions; the water vapour pressure change in the suit is determined by the surface temperature of the garment and the heat losses occurring in the body.

Body temperature is regulated by a dynamic balance between heat generation and heat loss mechanisms. Body internal temperature is tried to be kept at an average of  $37 \pm 1$  °C (within the limits of 36-38 °C). The rate of heat generation increases in mechanical work and exercise. Body internal temperature rises 1-2 °C above normal and is maintained between 38-39 °C (Yıldız and Arzuman 2009).

Especially during intensive activity, sportswear must enable the throw away excess heat and moisture from the human body. If excess heat and moisture are not removed from the body efficiently, heat stress occurs and the wearer's performance is adversely affected (Sawka and Young, 2000).

When designing sportswear, the most important parameter is functionality and this parameter is used together with style, color, production and design details. Depending on the climatic conditions to be used and the activity to be performed, waterproof and windproof properties are preferred, especially for winter sports clothes. The other important parameter is thermal resistance for winter clothes, the higher thermal resistance values were advantageous to preventing hypothermia. Hypothermia is a medical emergency that occurs when your body loses heat faster than it can produce heat, causing a dangerously low body temperature. On the other hand, in hot climatic conditions, breathable garments are preferred that quickly throw heat and water vapour out of the clothing and away from the body.

Comfort measurements can be made in two ways. The first of these is to conduct market research and reveal the characteristics of sports performance clothing of the products available in the market. The other way is to measure people's sense of comfort with subjective measurements such as quantitative comfort tests and wear trials.

The thermal resistance of clothing depends on many parameters such as fiber properties, structural parameters, thickness and covering factor. Some fibers like Cotton, Modal and Tencel were perceived as cool by consumers. On the other hand, Wool, Acrylic and Thermolite were perceived as hot by consumers during wear trials and forearm test results. The other important parameter is fabric construction and thickness which affect air permeability and water vapour resistance values.

The fiber structure, yarn structure, fabric construction and air permeability, which is a feature affected by the finishing processes of the fabric, are also in parallel with the thermal conductivity. Fabrics with good air permeability provide air circulation in the body, while fabrics with low air permeability prevent heat loss by interrupting air circulation and this can be affected by many features from fiber to fabric. Generally, the main parameters affecting the thermal properties of the fabrics are the thickness of the fabric, the amount of stagnant air in the fabric and the external air movement that occurs around the fabric. The most important parameter determining the still air amount is fabric porosity. The air surrounding the clothing materials consists of micro-layers located between the surfaces where the materials contact each other and the macro-layers located between the surfaces where the materials do not contact each other. The increase in any of these layers increases the thermal insulation. The heat transfer mechanism in fabrics occurs by conduction, convection and radiation by the air intervening with the conduction by the fibers, namely solid materials.

Water vapour permeability is one of the other important factor influencing the thermal comfort properties of clothing systems. Especially in hot environments and during intense activity, the excess amount of heat generated should be discharged to the outside in the form of sensible and non-sensible sweating. In these cases, the choice of clothes with high water vapour permeability facilitates the removal of sweat from the skin.

Fabrics with high water vapour permeability, that is, breathability, are especially preferred in areas where perspiration is high, such as active sportswear (Özkan and Kaplangiray, 2015). Because the human body discharges excess heat to the external through perspiration and evaporation under high activity and temperature conditions. Many researchers have stated that the amount of water vapour transferred from the textile surface to the external surrounding connected to the water vapour pressure difference between the microclimate and the external environment (Marolleau et al., 2020).

### **1.2.3. Physical Comfort**

Physical comfort or body motion comfort has not been studied as much as thermal comfort and tactile comfort. However, this comfort feature is at least as important as the others because people have to move by nature and clothes should be designed to allow these movements of people. The most important factor affecting freedom of movement is flexibility. The raw material that provides flexibility is the use of elastane in the yarn in fabric production. Depending on the thickness and percentage of the elastane used, the flexibility property changes. Hatch declared that the suitable interval of percent elongation for textile fabrics for tailored garments is between 15%–25%, for sports garments is between 20%–35%, for activewear is between

35%–50%, and for stretch garments are between 30%–40%. Joseph (1981) stated that the elongation amount is between 10% and 25% in daily clothes and between 35% and 50% in sportswear.

The design of the clothes used in daily life should be made according to the place of use and activity level. Especially with the emergence of Lycra and its place in clothing design, the popularity of snugly fitted clothes has increased. It can be said that the emergence of lycra has completely changed men's and women's fashion. In today's fashion, the clothes that fit the body are more preferred. Denton (1971) divides garments with elasticity into three categories: comfortable stretch garments do not stick to the body but will stretch and return to their original form with movement, tight-fitting leotards adhere to the body but do not exert any pressure, and pressurized stretch garments compress the body and apply pressure.

Sportswear with a compression function is very common, especially in endurance sports. Athletes want to increase their performance by wearing compression stockings, tights and tops. The expected benefits are better blood flow to the heart, faster recovery and less muscle release. Compression garments are used for the medical treatment of venous insufficiency. It affects the performance of athletes by affecting muscle shaking in sportswear and prevents injury during exercise. It has also been found to increase sprint performance by increasing the vertical jump height by reducing the swing of the thigh muscle during descending from the jump when wearing compression garments. It was developed as a second skin in 1996 and used in the London Olympics in 2012 and attracted a lot of attention. Today, compression garments are expected to be sold more widely, 5.3% from 2019 to 2024. In addition to large companies, there are other companies in this field (Kim and Baytar, 2020).

The impact of elastane linear density and loop length on the tensile, recovery and compression characteristics of weft knitted polyamide/elastane stretchable fabrics were investigated. To examine the stretch and recovery characteristics, the fabrics were tested under low power force and under cyclic loading under high tensile force. The pressure produced by the diverse PA/EL knitted sample clothing covers was measured with a Kikuhime pressure sensor. It was concluded that an increase in the elastane linear density, results in an increase in fabric layer density, area density, percentage recovery and compression (Umar et al., 2016).

### **1.3. Wear Trial Tests**

One of the most important ways to measure clothing comfort under dynamic conditions is to wear trials. Because thermal manikin systems, which are another way of measuring this, are very expensive. During the wear trials,

a selected group of subjects is exposed to a controlled environmental condition and the subjects are asked to follow a predetermined activity program. In the meantime, the subjects are asked to rate their comfort features with the help of the scales used. In cases where there is no physical equipment to objectively measure the thoughts and feelings of the user, the only way to measure subjective perceptions is to use psychological scales. Subjective tests are so named because their scoring is based on personal judgments or opinions of subjects. Slater (1986), investigated problems of subjective wear trial tests a) the measurements are dependent on the reliability of the subjects b) the variability of subjective perceptions requires numerous measurements to get a satisfying result c) the statistical analysis of subjective data is difficult d) psychological, physical, social and environmental factors cause inconsistencies in individuals responses. Despite these problems, wear trials are one of the important methods used to measure the effects of clothing on people.

People make judgments about tactile comfort by using their hands. But the vast majority of judgments about tactile comfort are made by other parts of the body. For this reason, it is necessary to use wear trial testing techniques in determining the sense of clothing comfort. The sense of clothing comfort is related to skin tactile systems and includes components such as visual, auditory, smell, taste and touch. Wear trials are performed in a certain environmental condition, where there are certain clothing and activity. Here, the perception of comfort; external stimuli (heat, humidity, wind, etc.) and mechanical stimuli applied by the fabric to the skin, physiological state (sweating), the material used in the garment, the body of the garment and the components of environmental conditions (temperature, humidity, air velocity) is affected.

Hollies (1984), worked on important properties of physiological scales:

- Measurement of generally known properties
- Using terms to describe features
- Using scales to determine the feature level
- A rubric for applying the rating scale to feature measurement
- Convenient data collection
- Checking of objective measurement outputs with psychological scales.

There are some works about wear trials in the literature:

The effectiveness of the ventilation systems of outdoor winter jackets was investigated and two jackets, one with PU coating and the other one with Teflon lamination, were produced and zippers were sewn from the armpits and arm parts. The experiments were carried out at  $20\pm 2^{\circ}\text{C}$  temperature and  $65\pm 5\%$  relative humidity, and six male subjects took part in the wear trials.



The subjective comfort perception was measured using a 4-point scale, the thermal perception was measured using a 9-point scale and humidity was measured using a 4-point scale. In both jacket types, it has been observed that creating openings on the garment significantly affects the skin temperature, and the faster cooling effect is more pronounced in the Teflon jacket (Ruckman and Murray, 1999). A wear trial was performed with three different clothing conditions semi-naked, synthetic garment and cotton garment, and eight male subjects were used in the experiments. It was compared to cotton and synthetic clothing, the skin temperature before exercise was lower, and there was no change in the main skin temperature and rectal temperature during and after exercise between these three clothing conditions in a semi-naked state. It was stated that neither the state of the garment nor the fabric properties of the garment had an effect on physiological, thermal balance, and comfort perception in moderately warm environmental conditions (Gavin et al., 2001). The effects of tight aerobic sportswear on physiological, psychological, thermal and moisture comfort were investigated. During wear trials, subjects were asked to rest for 30 minutes before dressing at  $29 \pm 2$  °C and 65% relative humidity, thus ensuring that their bodies were dry and cool. The subjects were asked to wear aerobic clothing that they chose randomly, and data were collected from 6 different parts of the body (chest, abdomen, inner thigh, outer thigh, back and waist) using temperature and humidity sensors during the 20-minute run (Wong and Li, 2004). The effects of using two different types of socks on foot skin temperature and whole body thermal balance were investigated and sixteen subjects took part in wear trials in a 30-minute training program on the treadmill. It was stated that the difference in sock type did not have a thermal or physiological effect during exercise, and in cases where subjective perception is more important than objective perception (Purvis and Tunstall, 2004).

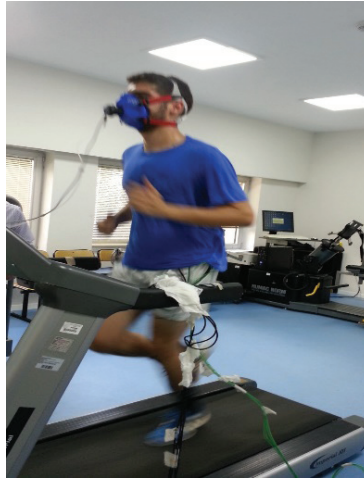
The comfort properties of a series of heat resistant workwear by making wear trials in a controlled environment investigated and found that air permeability, water vapor permeability and thermal resistance are not the determinative factors of human thermal comfort in single layer woven fabrics. It has been observed that the determining factors for tactile comfort are tactile responses such as softness, hardness, and stickiness, and liquid moisture management properties have significant effects on wearing comfort (Yoo and Barker, 2005). The effect of compression tights on oxygen consumption and subjective comfort evaluations in a submaximal exercise program were compared with classical clothing. Subjects were asked to score two different experimental conditions in terms of general comfort perception, sweating and thermal comfort. It has been observed that the use of compression tights during running exercise affects circulation and reduces muscle oscillation at a certain submaximal exercise speed, resulting in lower energy



consumption (Bringard et al., 2006). Two different phase-changing materials under two different operating conditions, one during surgery and the other in a warm environment were prepared. During the wear trials, metabolic rate, heart rate, skin temperature at thirteen points and body weight change were measured. In addition, thermal perception, thermal comfort, clothing and skin wetness were measured with the help of subjective scales. It was observed that thermal comfort was improved by decreasing thermal stress depending on the amount and distribution of PCM (Reinertsen et al., 2008). A study was conducted using different types of fabrics to achieve maximum thermal-wet comfort during exercise. For this purpose, wear trials of ten t-shirts made of ten kinds of hygroscopic fibers such as cotton, wool, lyocell, modal, soybean, bamboo and their blends were carried out in a standard environmental chamber. It has been seen that fiber type is one of the most important parameters affecting thermal-wet comfort during exercise (Wu et al., 2009). The effects of different types of fabric T-shirts on the physiological and psychological responses of subjects during and after intensive activity in a warm and humid environment were investigated with a wear trial. The experiments were carried out in an environment of 25 °C temperature and %60 relative humidity. Rectal temperature, skin temperature at eight points, heart rate, the weight of the shirt, thermal, wetness and sweating perception were measured before, during and after exercise. The results showed that polyester fabric causes sweating more than cotton but sweat is not collected in the garment (Brazaitis et al., 2010). In a study investigating the effects of T-shirt ventilative designs on thermoregulatory response during exercise, it was seen that ventilated clothing designs could affect the performance of heat and moisture transfer. It was observed that there was a significant difference in skin temperature, clothing microclimate temperature, oxygen uptake, respiratory exchange rate, sweat efficiency and comfort feeling between the control piece and the mesh fabric t-shirts in a windy environment during exercise (Xianghui and Jun, 2010).

The effect of carbon activated sports t-shirts on thermo-physiological comfort was investigated and a wear trial was performed in a controlled chamber with a 27 C° and %60 humidity level. The results showed that carbon affected PES fabric felt comfortable during moderate activity and rest periods. But this fabric felt less comfortable at the end of the physical activity (Splendore, 1986). The effect of wearing lower body compression garments on the performance of cycling sporters was investigated with a wear trial test. The difference between this study from previous studies was that the placebo effect was also taken into account (Galanville and Hamlin, 2012). The effects of phase-changing materials on thermophysiological comfort in men's workwear under hot ambient conditions were investigated under different physical activity and environmental conditions. Five differ-

ent men's workwear and three-layered clothing structures were used and five subjects of 22-23 ages took part in the wear trials. The results indicated that phase-changing materials (PCM) used in hot ambient conditions do not affect thermophysiological comfort very much, on the other hand, PCM and the clothing system have a small heating effect (Celcar, 2013). The effect of form fitted moisture wicking fabric T-shirts, promoted to have improved evaporative and ventilation properties, on physiological and psychological responses during exercise in the heat was investigated and found that a special t-shirt enables a significantly lower rectal temperature during the last 15 minutes of exercise (De Sousa et al., 2014). The performance properties of Viloft blended knitted fabrics were investigated with a wear trial. Eight different types of fabric were used in the experiments and the exercise protocol was composed of 45 minutes of exercise and 10 minutes rest period. The results showed that dampness sensation affects the performance of sportsman than hotness sensation during activity. It was declared that cotton fabrics are disadvantageous for high performance activities because it keeps moisture in cloth (Atasagun et al., 2015). The subjective clothing comfort and physiological parameters were tested with a wear trial. Five women subjects participated in wear trials and tried women's summer clothes. The results showed that there is a connection between subjectively and objectively measured properties (Grujic and Gersak, 2017). The comfort properties of commercially available cycling clothes were investigated with a wear trial. Tactile comfort, fit, and garment aesthetics properties were asked with a questionnaire. The results showed that tactile comfort was perceived more differently by the subjects than thermal comfort. Also, thermal comfort is affected by environmental conditions, activity level, and fabric constructional properties (Teyeme, 2020). The thermophysiological comfort of five different types of T-shirts was investigated after an activity period. Ten subjects performed a wear trial test and during the rest period, microclimate temperature and microclimate relative humidity values were recorded with a data logger sensor system. The results showed that TS coded Tencel single jersey fabric showed the lowest temperature values for all measured body locations. Also, abdomen microclimate temperature values increased in the relaxing period (Özkan et al., 2019). Figure 3 shows an example of a wear trial test with a treadmill. In the following sections, sensor systems used in microclimate temperature and relative humidity measurements in wear trials and subjective scales used in wear trials will be discussed in detail.



**Figure 3.** *An example of wear trial test with a treadmill (Özkan, 2018).*

### **1.3.1. Physiological measurements made during the wear trial**

Wear trials are carried out in a controlled environmental condition and this environmental condition must be suitable for the climatic condition in which the garment will be used later on. A certain activity program is applied to the subjects, especially during the application of the wear trial procedures of sportswear. This activity program includes the data obtained through the subjective perceptions and objective measurement methods that the person feels the first time the garment is worn, during the activity, and during the resting state. These data included such as skin surface temperature, microclimate temperature and microclimate relative humidity. The microclimate is a substantial factor for wear comfort and depends on properties, such as moisture and heat transport through the material, and on physiological and surrounding conditions (Zhong et al., 2006). Temperature and humidity sensors are used in microclimate temperature, microclimate relative humidity, and skin point temperature measurements. These sensors are connected to a data collector called a datalogger. Due to the datalogger, the data obtained from the subjects are recorded by a computer which means the data of the subjects can be followed instantly. In addition, by using thermal camera systems, surface temperature measurements can be made on the garment.

During the wear trials, subjective evaluations are made as well as objective measurements. For example, the person's perception of temperature, wetness and general comfort is measured with the help of subjective scales. Subjective rating scales used in clothing essays are arranged to focus on an aimed appearance of an object or a different appearance of an object to externalize a general attitude. The most well-known of these is the Likert

scale which is commonly used in different psychometric works and psychological evaluations to decide senses. The perceived comfort of activewear is vigorously influenced by five key characteristics: (a) physical, (b) psychological, (c) physiological, (d) psychophysical, and (e) psychophysiological characteristics (Liu and Little, 2009). Thermal properties, tactile properties, and pressure exerted by the garment on the body are important factors for sportswear users, and the perceived comfort level of users can be measured with the help of subjective scales.

In a previous study, the scales used in subjective measurements were divided into four groups:

- In nominal scales, numbers do not have superiority over each other when used to group objects.

- Ordinal scales are graded on the basis of their priorities relative to each other. Here, it can be stated that one feature has priority over the other, while the degree of priority is not specified.

- Interval scales allow the features to be ranked using numerical values. Finding the numerically equal distance between the categories shows that there are differences between the evaluated features at the same rate.

- In ratio scales, similar to interval scales, the relative importance of features can be stated proportionally (Li, 2001).

Scale selection can be made according to the work to be done and the desired rating. While most studies use a 5-point rating scale, there are also wear trial studies using 7- and 9-point scales (Wong et al., 2004). The effect of graduated compression stocking on the running performance of athletes was investigated with subjective scales used during the study. The rules of the wear trial were explained to participants so as to ensure they gave correct answers for subjective perception (Ali et al., 2011). The effects of garment openings on thermal comfort were measured during exercise, seven garments produced from different mesh styles and a 100% cotton garment were preferred as control garments. A seven-point scale was used to measure the thermal comfort perceptions of the subjects and a five-point scale was used to measure their humidity comfort perceptions (Xianghui and Jun, 2010). The comfort properties of double-sided fabrics used in tennis clothes were measured, six different T-shirts of the same model were created and 45 tennis players were selected for the wear trials of these clothes. With the questionnaire method used, properties such as thermal comfort, thermal perception, and personal tolerance were measured with the help of subjective scales (Suganthi and Senthilkumar, 2018). Wear trials of sportswear were carried out in an artificial climate room and examined by the method of thermal physiological response and subjective perception scales. In the subjec-

tive test performed in rainy conditions, it was observed that the feeling of discomfort increased due to raindrops falling on the skin, unlike the general conditions, the feeling of cold increased after exercise and the feeling of humidity reached its peak. In addition, the feeling of humidity was measured with the help of the subjective scales used (Kwon, 2000).

### 1.3.2. Sensor Systems Used in Wear Trials

There are many sensor systems produced by different companies to be used in wear trials in the market. The features that these sensors can be summarized as accuracy, proper storage of data and easy access to data, and 7/24 wearability. Due to the datalogger systems, the temperature and relative humidity of the area between the clothing and the body, called the microclimate, can be easily measured. The effect of the clothing on the athlete can be measured during the activity process with the datalogger system. Previously, these measurements were subjectively evaluated according to the results of the questionnaires made to the subjects, but these systems enable more accurate and online measurements.

A microclimate is a name given to the air layer between the human skin and clothing, which determines the feeling of comfort of the person. Microclimate temperature and microclimate relative humidity measurements were taken with the help of Datalogger (Figure 4). This datalogger device has 8 outputs and allows 8 humidity sensors to be connected to the device. Thus, temperature and humidity measurements can be made in at least eight parts of the body.



**Figure 4.** *An example of datalogger and measuring units (Özkan, 2018).*

Examples of studies using sensor systems are given below: the comfort properties of a group of sports garments with objective and subjective measurement methods were made with the help of subjective scales and a sensor system. Subjective feelings of subjects were asked like coolness, dampness and general comfort with a previous study. The subjects answered the questions according to used scales and after each activity period. Also, microclimate temperatures of the back and chest region were measured with a sensor system (Kaplan and Okur, 2012). The thermal and moisture comfort

properties of two different types of jumpers made of wool and acrylic were measured from their inner and outer surfaces by means of thermocouples used in an abrasion test. Subjective evaluation results showed that wool was warmer, drier and more comfortable than acrylic after getting wet (Li, 2005).

The effect of compression garments on thermoregulation during a team sports activity was investigated by twelve amateur hockey players who took part in wear trials. Intermittent shuttle tests which were composed of 4x15 minute with 6-12 day intervals were done in random and counterbalanced order. During wear trials, a wireless sensor system was used to measure skin temperatures (Houghton et al, 2009). Sensor systems can be used to measure the thermal performance of protective clothing as well as sportswear. For example, protective clothing worn by firefighters must not only provide thermal protection property but also provide thermal and moisture comfort. Since the comfort feature of protective clothing has a major effect on work productivity, it is necessary to search the heat and humidity comfort characteristics of these clothes under different temperature conditions. In a study, two different wear trials were carried out at 28°C (warm) and 15°C (cold) temperatures. The four thermal sensors made by RS Component Ltd., UK (accuracy  $\pm 0.01^\circ\text{C}$ ) were used in the measurements of skin temperature (Wang et al., 2013). Thermal simulation of close-fitting sports garments was investigated with a wear trial test. The skin temperature and wetness of subjects were measured with MSR 345 Datalogger which is used for recording the measured data. The temperature and humidity sensors were attached to the body of the subjects from nine different points. A spot-on system was used for temperature measurements and placed forehead of subjects (Awais et al., 2020). In a study on the thermal properties, physiological responses and environmental conditions of chemical protective clothing; skin temperature, heart rhythm and heat storage properties were measured using a sensor named Cor-Temp capsule temperature sensor (HQ Inc., Palmetto, FL). Skin temperatures (YSI409b, 4000A, YSI Inc., Dayton, America) were taken from eight body regions, such as the shoulder, chest, forearm, and hand, using skin temperature sensors (Zhang et al, 2021). Apart from the sensors that measure the microclimate temperature, there are also pressure sensors used to measure body movement comfort in the market. These are divided into four sections pneumatic pressure sensors, capacitive pressure sensors, piezoelectric pressure sensors and resistive pressure sensors (Lai and Li-Tsang, 2009). Since thermal comfort measurements are mostly mentioned in this study, detailed information about the sensors used in pressure measurement is not given in this chapter.

## CONCLUSION

As a result of sports becoming a lifestyle, sportswear types and expectations from sportswear have gradually increased. While previously only sports clothes in which one can move comfortably were preferred. Nowadays, clothes that provide heat and humidity comfort to the sporters, thermal resistance properties change according to used climate conditions and which apply a certain pressure to increase the athlete's range of motion are produced. The aim of this study is to give information about the wear trials that enable the research of the thermal comfort properties of sportswear before the user. Thus, the effects of these garments on the end user will be determined in advance, thanks to the previously tried clothes according to the activity condition in which they will be used. The information about previous studies on wear trials is given in this chapter. In addition, information is given about the sensor systems used in sportswear trials and the subjective scales used. As a result, this study will contribute to the literature about sportswear wear trials.

## REFERENCES

- Ali, A., Creasy, R.H., Edge, J.A. (2011). The effect of graduated compression stockings on running performance. *Journal of Strength and Conditioning Research*, 25(5), 1385-1392.
- Annual Book of American Standard Tests and Materials, 1997.
- Ataşgun, H.G., Öner, E., Okur, A., Beden, A.R. (2015). A comprehensive study on the general performance properties of Viloft-blended knitted fabrics. *The Journal of The Textile Institute*, 106(5), 523-535.
- Awais, M., Krzywinski, S., Wölfling, B.M., Classen, E. (2020). Thermal Simulation of Close-Fitting Sportswear. *Energies*, 13: 1-13.
- Brazaitis, M., Kamandulis, S., Skurvydas, A., Daniusevičiūtė, L. (2010). The effect of two kinds of T-shirts on physiological and psychological thermal responses during exercise and recovery. *Applied Ergonomics*, 42(1), 46-51.
- Bringard, A., Perrey, S., Belluye, N. (2006). Aerobic energy cost and sensation responses during submaximal running exercise-positive effects of wearing compression tight. *International Journal of Sports Medicine*, 27, 373-378.
- Celcar, D. (2013). Influence of phase-change materials on thermo-physiological comfort in warm environment. *Journal of Textiles*, 1-9.
- De Sousa, J., Cheatham, C., Wittbrodt, M. (2014). The effects of a moisture-wicking fabric shirt on the physiological and perceptual responses during acute exercise in the heat. *Applied ergonomics*, 45(6), 1447-1453.
- Denton, M. J. (1971). Fit stretch and comfort, in Proc Third Shirley International Seminar, 15-17 June, Manchester, England Cotton, Silk and Manmade Fibres Research Association, pp 1-11.
- Gavin, T., Babington, P., Harms, C., Ardelt, M., Tanner, D., Stager, J., (2001). Clothing fabric does not affect thermoregulation during exercise in moderate heat. *Med. Sci. Sports. Exerc.*, 33(12), 2124-2130.
- Glanville, K.M., Hamlin, M.J. (2012). Positive Effect of Lower Body Compression Garments on Subsequent 40-kM Cycling Time Trial Performance. *Journal of Strength and Conditioning Research the TM*, 26(2), 480-486.
- Grujic, D, Gersak, J. (2017). Examination of the relationships between subjective clothing comfort assessment and physiological parameters with wear trials. *Textile Research Journal*, 87(12), 1522-1537.
- Hatch, K.L. 1993. Comfort Properties, Textile Science. MN: West Publishing, 26-27.
- Hollies, N.R.S., Demartiono, R.M., Yoon, H.N., Buckley, A., Becker, C.L., Jackson, W. (1984). Improved comfort polyester, *Textile Research Journal*, 54(8), 447-458.
- Houghton, L.A., Dawson, B., Maloney, S.K. (2009). Effects of wearing compression



- garments on thermoregulation during simulated team sport activity in temperate environmental condition. *Journal of Science and Medicine in Sport*, 12, 303-309.
- Joseph, Marjory L. 1981. Introductory textile science. Holt, Rinehart, and Winston, p: 432.
- Kaplan, S., Okur, A. (2012). Thermal Comfort Performance of Sports Garments with Objective and Subjective Measurements. *Indian Journal of Fibre and Textile Research*, 36, 46-54.
- Kawabata, S., Niwa, M. (1996). Recent Progress in the Objective Measurement of Fabric Hand. In: Ito, Y., Okamura, S., Rånby, B. (eds) *Macromolecular Concept and Strategy for Humanity in Science, Technology and Industry*, Springer.
- Kim, Y., Baytar, F. Men's purchase behavior and fit preferences for compression sportswear for fitness. In *Proceedings of ITAA 2020*.
- Kwon, K. (2000). The Study on the Physiological Response in Wearing Sportswear in Two Different Environments. *Fashion & Textile Research Journal*, 2(5), 416-422.
- Lai, C. H. Y., Li-Tsang, C. W. P. (2009). Validation of the pliance X system in measuring interface pressure generated by pressure garment. *Burns*, 35(6), 845–851.
- Liu, R., Little, T.J. (2009). Optimizing 5Ps for compression athletic wear comfort in sports. *Journal of Fiber Bioengineering and Informatics*, 2(1), 44–55.
- Li, Y. (1988). The Objective Assessment of Comfort of Knitted Sportswear in Relation to Psycho-physiological Sensory Studies, in Department of Textile Industries, The University of Leeds, Leeds, p: 213.
- Li, Y. (2001). The Science of Clothing Comfort. Textile Institute Publications, Textile Progress, United Kingdom, 31 (1/2), p:138.
- Li, Y. (2005). Perceptions of temperature, moisture and comfort in clothing during environmental transients, *Ergonomics*, 48(3), 234- 248.
- Marolleau, A., Salaün, F., Dupont, D., Gidik, H., Ducept, S. (2020). A New Method for Measuring Water Vapour Transfers Through Fabrics. *Fibers and Polymers*, 21(3), 646-656.
- Newbery, M. (2009). Global Market Review of Active Sportswear and Athletic Footwear – Forecasts to 2016, Aroq Limited, Worcestershire.
- Özkan, E.T., Kaplangiray, B. (2015). Thermophysiological comfort properties of different knitted fabrics used in cycling clothes. *Textile Research Journal*, 85(1), 62-70.
- Özkan, E.T. (2018). Investigating thermophysiological and aerobic performance properties of different raw material and knitting sport clothes, Uludağ University PhD Thesis, Department of Textile Engineering, Bursa.

- Özkan, E.T., Kaplangiray, B., Şekir, U. (2019). Thermophysiological Comfort Properties of Different Clothes After an Activity Period. *Uludağ University Journal of The Faculty of Engineering*, 24(3), 1-12.
- Purvis, A., Tunstall, H. (2004). Effects of sock type on foot skin temperature and thermal demand during exercise. *Ergonomics*, 47(15), 1657-1668.
- Reinertsen, R.E., Færevik, H., Holbø, K. Nesbakken R. (2008). Optimizing the performance of phase-change materials in personal protective clothing systems. *International Journal of Occupational Safety and Ergonomics*, 14(1), 43-53.
- Ruckman, J.E., Murray, R. (1999). Engineering of clothing systems for improved thermophysiological comfort. *International Journal of Clothing Science and Technology*, 11(1), 37-52.
- Sawka, M.N and Young A J, (2000). Physical exercise in hot and cold climates. In William E, Garrett W Jr and Donald T K, ed. *Exercise and Sport Science*, Philadelphia, Lippincott Williams & Wilkins, p: 385-400.
- Slater, K. (1986). The assessment of comfort. *Journal of Textile Institute*, 77, 157-171.
- Splendore, R, Dotti, F., Cravello, B., Ferri, A. (1986). Thermo-physiological comfort of a PES fabric with incorporated activated carbon. *International Journal of Clothing Science and Technology*, 23(5), 283-293.
- Suganthi, T., Senthilkumar, P. (2018). Comfort properties of double face knitted fabrics for tennis sportswear. *Indian Journal of Fibre & Textile Research*, 3: 9-19.
- Teyeme, Y., Malengier, B., Tesfaye, T., Vasile, S., Langenhove, L.V. (2020). Comfort Evaluation of Cyclists Jerseys Using Wear Trial Test, *Tekstilec*, 63(4), 263-275.
- Umar, J., Hussain, T., Maqsood, M. (2015). Modeling the mechanical and compression properties of polyamide/elastane knitted fabrics used in compression sportswear. *The Journal of The Textile Institute*, 107(10), 1240-1252.
- Wang, Y., Zhang, Z., Li, J., Zhu, G. (2013). Effects of inner and outer clothing combinations on firefighter ensembles' thermal- and moisture-related comfort levels. *Journal of The Textile Institute*, 104(5), 530-540.
- Wong, A.S.W., Li, Y. (2004). Relationship between thermophysiological responses and psychological thermal perception during exercise wearing aerobic wear, *Journal of Thermal Biology*, 29, 791-796.
- Wu, H. Y., Li, J., Zhang, W. Y. (2009). Study on improving the thermal-wet comfort of clothing during exercise with an assembly of fabrics. *Fibres and Textiles in Eastern Europe*, 17(4), 46-51.
- Xianghui, Z., Jun, L. (2010). Effects of clothing ventilative designs on thermoregulatory responses during exercise. *Biomedical Engineering and Computer Science (ICBECS)*, 23-25 April, Wuhan.
- Yıldız, SA., Arzuman, P. (2009). Exercise in hot environment. *İstanbul Tabip Odası*

*Klinik Gelişim Dergisi*, 22, 10-15.

Yoo, S., Barker, R.L. (2005). Comfort properties of heat-resistant protective workwear in varying conditions of physical activity and environment. Part I: Thermophysical and sensorial properties of fabrics, *Textile Research Journal*, 75(7), 523-530.

Zhang, C., Chen, Y., Liang, G., Wang, X., Zheng, X., Ding, S. (2021). Heat strain in chemical protective clothing in hot-humid environment: Effects of clothing thermal properties, *Journal of Central South University*, 28(12), 3654-3665.

Zhong, W., Xing, M.M.Q., Pan, N., Maibach, H.I. (2006). Textiles and Human Skin, Microclimate, Cutaneous Reactions: An Overview. *Cutaneous and Ocular Toxicology*, 25(1): 23-39.

### **Website References**

Url-1< <https://www.businessoffashion.com/articles/intelligence/activewear-lululemon-nike-hm-sweaty-betty>> , date retrieved 12.05. 2014.

Url-2< <https://www.fortunebusinessinsights.com/sportswear-market-102571>> , date retrieved 12.05.2022.





## **CHAPTER 5**

# **INVESTIGATION OF MEDICINAL AND AROMATIC PLANT SPECIES IN COSMETICS**

*Ece Türedi<sup>1</sup>*

*Nil Acaraltı<sup>2</sup>*

---

1 Yildiz Technical University, Department of Chemical Engineering, Davutpasa Campus, 34210, Esenler-Istanbul, Turkey.

2 Yildiz Technical University, Department of Chemical Engineering, Davutpasa Campus, 34210, Esenler-Istanbul, Turkey. nilbaran@gmail.com

## INTRODUCTION

The increasing importance of concepts such as sustainability, recycling, naturalness, and healthy life brings with it the development of nature-friendly systems and products that do not endanger ecology and human health. Considering the health hazards of synthetic chemicals, the demand for natural products has increased, and the use of natural raw materials and plants has become widespread in many sectors. In this direction, appropriate research and development studies are carried out in many industrial fields from food to medicine, from paint to textile, from agriculture to cosmetics, and environmentally friendly products with high biological value are developed. Since ancient times, people have been using botanicals for many purposes such as curing ailments, adding flavor to foods, and developing natural cosmetic products. It is known that the essential oils and extracts obtained from various parts of plants as medicinal and aromatic, which provide lots of biological benefits, are widely used in fields such as aromatherapy and traditional medicine (Türedi, 2021).

Aromatic and medicinal plants can be defined as botanicals used for many years in the world, such as preventing human and animal diseases, adding flavor to foods, and protecting them, developing natural cosmetic products, and benefiting almost everyone. Plants grown from parts such as roots, seeds, branches, leaves, fruits, and tubers in the pharmaceutical industry for the purpose of curing and preventing diseases are called medicinal plants, and plants from which essential oils are obtained and used to give a good taste and smell are called aromatic plants (Mutlu, 2020). In Figure 1, sage, black cumin, lavender, and aloe vera are shown as examples of medicinal and aromatic plants.



**Figure 1.** Some examples for medicinal and aromatic plant species (Serencam, et al., 2018)

Besides the global spread of traditional medicine's popularity, another major trend is to develop new pharmaceutical products from valuable natural resources. This orientation, which is called phytotherapy in a way, is both a very old and successful practice. Although there are still largely unexplored aspects, historically plant-based natural products are constantly being researched as they give effective results in pharmaceutical (drug design) development, in this context, many scientists have found that chemical substances and plant extracts in plants have antimutagenic (substance that prevents the effect of the factor that causes genetic changes). working on its potential. In line with the studies, the antimutagenic activities of aromatic and medicinal plants have been tested and it has been proven that they prevent mutagenic and carcinogenic effects thanks to the bioactive compounds in their structure. However, it has been reported that such compounds show a wide variety of biological impacts such as antimicrobial, antioxidant, anti-allergic and anti-inflammatory and it has been determined that natural antimutagens obtained from medicinal and aromatic plants do not have undesirable toxic effects on living organisms (Ganaie, 2020).

Today, another tendency is the increase in the use of synthetic substances in many parts of the world due to their rapid and powerful effects. However, with these developments, less harmful compounds are now more preferred due to the reproduction of unwanted organisms, pollution of water resources, and negative effects on humans and animals. It has been seen as an attractive alternative because the metabolism of plants is in a structure that can cope with the harmful substances around it. Therefore, since various products obtained from plants have antimicrobial properties, some compounds and extracts are used directly to produce substances used as herb, insect, and plant pathogen protectors (Lubbe & Verpoorte, 2011). Besides the products related to food industry and human health, there is a need for antioxidants that protect product quality in the production of rubber, plastic, and paint, and in the design of better automobile fuels and oils. In this direction, studies on the production of plant-based antioxidants as an alternative to those on the market have begun to increase, and many data have been obtained on the antioxidant activity of essences getting from plants of various species, harvested in different places (Miquel, 2010).

There are research results based on the biological activity of the chemical compositions of essential oils obtained from medicinal and aromatic plants, whose geographical origin is affected by various factors such as environmental and agricultural conditions, and the inhibitory properties of these substances against the growth of some microorganisms and fungi. As a result of the antibacterial properties analysis carried out by a team of scientists on this subject, it was concluded that the oils of plants such as thyme, lavender, sage prevent the growth of all microorganisms (Piccaglia et al., 1993).

In classification of aromatic and medicinal plants, it is not possible to examine them under a single group due to the high number and diversity of plants, as well as the differences in the active substance content and mode of action of the plants. Although there is no standard and definite grouping in international and scientific context, the classifications made in general are a guide according to the sector, research, and institutions. In this context, medicinal and aromatic plants are classified in different ways as alphabetical, morphological, botanical, chemical, pharmacological, pharmacological, pharmacological (Atılabey et al., 2015; Aslan & Karakuş, 2019).

There are two main types of metabolites called primary and secondary metabolites in the biochemical structure of plants. Primary metabolites are substances produced during active cell proliferation, which are generally essential for life, essential for the formation and continuation of life (amino acids, vitamins, etc.), they are found in every plant variety. Secondary metabolites, on the other hand, can be defined as substances that play a role in the interaction of the organism with its environment, that the plant can maintain its vitality in case of its deficiency, that are found only in some plants and that give the plant a characteristic feature and that can be stored at certain amounts. In addition, it is usually found in plants as small compounds at low concentrations and secondary metabolite groups are used as criteria for botanical classification. Most of the secondary metabolites are generally multifunctional compounds, due to their ability to carry more than one pharmacologically active chemical group. It has been used by mankind for thousands of years as dyes, flavorings, fragrances (essential oils), stimulants (caffeine, nicotine), hallucinogens, insecticides, and most importantly, therapeutic agents. Given these industrial interests, the secondary metabolite of plants is in great demand and has great economic value (Van Wyk & Wink, 2017; Tong et al., 2021).

Secondary metabolites in plants are chemically divided into three groups;

- Terpenes
- Phenolic compounds
- Nitrogenous compounds

If plants used as medicinal and aromatic are evaluated in terms of usage areas, people have been trying to adopt a healthy lifestyle and eating habits, especially since the 21st century. Studies are carried out in various sectors for the development of products and foods that meet this demand. In this context, one of the most common areas of use is the food industry, due to the proven benefits of medicinal and aromatic plants on human health (Figure 2). Plants have been used as food and dietary supplements, food additives,



nutraceuticals, spices, and condiments in the kitchen from past to present. Plant nutraceuticals are currently internationally recognized substances that, when consumed regularly as part of a varied diet, offer potential solutions for the long-term prevention and treatment of inflammatory disorders and major chronic diseases, including cancer. But they are not considered drugs. These products are usually concentrated and consumed in liquid, capsule, powder, or pill form. The reason for the rapid growth of the market share of plant nutraceuticals day by day can be explained by the fact that consumers consume products with high nutritional value, preferably produced from natural sources, against standard diets. Therefore, it has great potential for the future (Taroncher et al., 2021).



**Figure 2.** Usage of plants as aromatic and medicinal in food industry (Aslan & Karakuş, 2019)

According to the World Health Organization, about 21,000 medicinal plant species are used for different medical applications (Giannenas et al., 2020). In the civilizations of the past and in many countries, especially in India, China, Egypt and Syria, herbal medicine has been applied and the origins of modern medicine, which has an important potential, have been created today. Medicinal and aromatic plants and essential oils obtained from them have been used in prevention of ailments and treatment, as they provide antioxidant, anti-inflammatory, anti-mutagenic, antimicrobial and many other biological benefits according to their active ingredients on human health. In this direction, today, related to the data of the World Health Organization, it is known that approximately 80% of the world's population tends to traditional medicine and phytotherapy applications based on scientific foundations. Also, the worldwide market of medicinal plants is getting stronger day by day and functional pharmaceutical products have attracted great interest in recent years. This is an indication that despite the increasing development and growth of the pharmaceutical industry, ethno-medicine is still relied upon to treat major ailments in the world (Saleem et al., 2021). Morphine (from opium poppy), quinine (from cinchona bark), digoxin (from foxglove), aspirin (from willow bark), allicin with its antidiabetic properties, nicotine, and caffeine useful for brain functions can be given as examples of

effective plant-based drugs (Giannenas et al., 2020). These and many other herbal raw materials containing drugs are being researched and developed especially by developing countries due to their minimal side effects against the human body. Therefore, besides the food sector, the use of herbal products and substances has an important place and market share in the pharmaceutical sector.

In the cosmetics sector, which is another important area of use, natural cosmetic products in general; it can be defined as a product group that does not contain chemically synthesized molecules that have a gentle effect on the skin, come from an environmentally friendly production process or are produced by a process that is not tested on animals. In these days, China, South Korea, Japan, and France are seen as the leading countries in the development of natural cosmetics (Faccio, 2020).

As stated, the development of cosmetic products that do not have a negative effect on health and the environment, have less toxic content and are not tested on animals, is a more conscious production effort based on sustainability values and clean formulas. In this direction, physicochemical analyzes and ethnobotanical studies on aromatic and medicinal plants create the potential to develop modern and sustainable cosmetic products (Figure 3). Surfactants, which are widely used in the formulation of cosmetic products, are the components responsible for the formation of emulsions (creams, etc.), foams, wetting capacity of products, cleaning properties and additionally antioxidant and antimicrobial activities. However, since most of the synthetic surfactants are petroleum-derived components, their residues in soil and groundwater pose a threat to human and environmental health, they are toxic and non-renewable. Therefore, surfactants derived from various microorganisms and plants are extensively studied and applied by many developers around the world, as well as seen as a commercial alternative, due to their low toxicity or non-toxicity, biodegradability, and sustainability. (Bezerra et al., 2021).



**Figure 3.** Usage of plants as aromatic and medicinal in cosmetic industry (Aslan & Karakuş, 2019)

The reason why herbal formulations are seen as an alternative to products with synthetic raw materials can be given as an example from the shampoos we frequently use in our daily life. The negative effects of adding synthetic surfactants to shampoos for foaming and cleaning functions are the fact that the hair dries out gradually, begins to fall out, and causes irritation to the scalp and eyes because of regular use. However, in addition to these negative effects, it is a difficult practice to formulate cosmetic products using completely natural raw materials (Badi & Khan, 2014).

Pesticides can be defined as a compound or mixture of ingredients developed to prevent, destroy, or mitigate the harmful effects of various organisms. Pests and the diseases they cause are responsible for most of the losses related to agricultural products in the field or in the warehouse. Pesticides used to prevent damage to the produced crop provide a more profitable harvest by protecting the products from insects and harmful organisms at the stages of harvest, crop growth and storage. It is common practice to produce plant-based products with a long history in many countries, especially in India, China, Egypt, and Greece, and used to protect crops from insects, weeds, and microbes. In the 20th century, the use of synthetic chemical pesticides became widespread and interest in plant-derived substances decreased relatively. The rapid and strong effects of synthetic pesticides on problems have increased crop yields in many parts of the world, as well as undesirable effects such as pollution of groundwater, acute and chronic poisonings on humans, and resistance of pest populations. Concerns over such problems in recent years have brought a solution to the ban or restriction of dangerous compounds, as well as the use of less harmful pesticides. Various pesticides obtained from plants are used to control weeds, insect pests and microbial pathogens. Examples of the best known are rotenone isolated from the roots of *Derris lanchocarpus*, pyrethrins extracted from *Tanacetum cinerariaefolium* achenes (dalmatian chamomile), and azadirachtins obtained from the seeds of the Indian neem tree. Among the reasons why plant-derived pesticides are preferred over synthetic ones to ensure efficiency in crop production while protecting consumer health, and to produce in a sustainable way; it can be shown that they are cheap, biodegradable, eliminate more specific problems with their mechanism of action, are environmentally friendly and therefore less dangerous to human and environmental health. Terpenes, phenolic and nitrogenous compounds, which are specified as the active ingredients of plants used as medicinal and aromatic, are also preferred as the raw material of these agricultural pesticides because they have bioactivity on insects and are seen as the most suitable alternative today (Souto et al., 2021; Lubbe & Verpoorte, 2011).

Ethnoveterinary medicine is a system that is based on traditional methods, people's beliefs, indigenous knowledge, skills, and practices for the

treatment of animal diseases and protection of animal health and has reached the present day by coming from thousands of years of history and passed down from generation to generation. Ethnoveterinary medicine is also a sustainable, environmentally friendly, cost-effective, and feasible method. It provides sustainable development, increasing animal productivity, and improving the living standard of small-scale farmers economically (Yipel & Yipel, 2014; Busari et al., 2021). Ethnoveterinary practices are applied in most of the developing countries in the world, including the East and Southeast Asian regions, and essential oils of plants which has aromatic and medicinal feature are used. Examples are the usage of pine oils against ectoparasites and for wound disinfection, the use of anise, cumin, and fennel to prevent gastrointestinal problems such as colic and bloating, and chamomile and yarrow to treat inflammations (Franz et al., 2009; Giannenas et al., 2020).

Until the 19th century, compounds extracted from plants were used as natural colorants or dyes. For example, dyeing was done using indigo for blue, turmeric, and saffron for yellow, chestnut for brown, and safflower and root dye for red. Later, the invention of the first synthetic dye by William Henry Perkin in 1856 changed the situation, and then such dyes were accepted more quickly due to different applications in various fields such as food, cosmetics, photodynamic therapy. The widespread use of synthetic dyes at the beginning of the 20th century, especially in the textile industry, provided dyeing convenience and a significant decrease in dyestuff costs per product was achieved. However, natural products have become popular again in the last few years due to the growing public awareness of the harmful environmental effects of the production of such dyes, the need for sustainable dye sources, their toxicity and non-biodegradable nature. Natural dyes in various chemical classes have been obtained from certain parts of plants and have quickly found use in other industries such as cosmetics, food, construction, paint, and varnish industry, as well as coloring natural fibers in textiles such as wool, cotton, linen, and hemp.

The advantages of using natural colorants can be listed as follows;

- Colorants of natural origin are environmentally friendly, safe for body contact in textile products, thus, besides not harming health, they sometimes function as a health care agent.
- They are obtained from renewable resources and contain the minimum possibility of chemical reactions during the production stages.
- Shades produced by natural dyes or colorants are generally soft, bright and have a soothing effect to the human eye.

However, natural dyes have not completely replaced synthetic dyes, but

they have their own place in the market (Lubbe & Verpoorte, 2011; Prabhu & Bhute, 2012).

Cosmetics, etymologically, is a concept that comes from the Greek word 'kosmetikos', meaning beautifying, regulating. cosmetic products by the European Regulation; It is defined as substances or mixtures whose main purpose is to clean, smell (perfume), change its appearance, protect, or keep it in good condition to be applied to exterior parts of body such as hair, external genitalia, teeth, hair, or mucous tissue in mouth (Bom et al., 2019). In the literature, there are many classification methods of cosmetic products based on the application area (face, body, hair, hair, nails, oral mucosa, teeth, genital area), purpose of use (cleanser, moisturizer, anti-wrinkle and stain, colorant, sunscreen etc.), structure of the product (solution, emulsion, suspension, gel, aerosol, paper, powder, etc.).

The use of plants is as old as human history and in the coming years, products containing natural oils, medicinal and aromatic plants will continue to be increasingly developed in many industries and markets. The personal care industry, on the other hand, is currently focusing more on herbal cosmetics, as it is a rapidly growing sector with a wide spectrum and a sustainable approach has become the focus. The purpose of using bioactive phytochemicals obtained from various botanicals in cosmetic products is to provide different essential oils, antioxidants, vitamins, proteins, terpenoids and other bioactive molecules. In addition, plant components can have the feature of supporting synthetic components such as preservatives, anti-pollution, whitening and sunscreen agents. In this direction, natural ingredients, aromatic plants and oils have many purposes such as to add a pleasant aroma to perfumes, to soften the skin in skin products, creams and lotions, to increase its elasticity, to positively affect its health and appearance, to add fragrance and shine to hair care products, to care for hair are included in finished products. Plants were once used as the primary source of products in all cosmetic classes, before methods and applications were discovered for artificially synthesizing such medicinal, biologically beneficial plant-like substances (Aburjai & Natsheh, 2003).

Turkey is advantageous in providing a variety of plants that can be used in cosmetic product formulations, thanks to its wide biodiversity and different climatic conditions. However, besides the fact that plants play an important role in natural cosmetics with increasing sales, the increasing demand and production of these natural cosmetic products also affects the distribution of plants and their chemicals, which threatens habitats and causes loss of species, damages the future due to climate change, causes loss of biodiversity globally. It is foreseen that they can create threats that affect rapidly. Therefore, plants under the threat of global warming and at risk of extinction should be considered when searching for content with new studies. Invest-

ment and improvement studies in ethnobotanical studies in industrialized countries can minimize the loss of information as a temporary solution (Faccio, 2020).

The raw materials used in cosmetics are developing day by day, and new ingredients are included in research and development studies. The basic raw material used in a cosmetic product is water. In addition, raw materials such as surfactants, emulsifiers, oils, extracts, essences, thickeners, back-lubricants, and pigments are used. Surfactants are substances that reduce the difference in surface tension between two substances in water or in aqueous solutions. From another point of view, they are agents that allow water to wet the material to be washed more easily and dissolve and remove oily dirt by emulsifying it (Lochhead, 2017; Tadros, 2005).

Apart from this, thickeners are used in the formulations of products such as creams and liquid soaps to provide the necessary rheology. In addition, essences that can be natural or synthetic to provide a pleasant smell, which is one of the most important features that make the product attractive, pH balancers, preservatives can be shown as raw materials used in cosmetics in general. As mentioned, because of investigations that are developing and changing every passing day, raw materials in cosmetic products are developed and produced by considering customer demand, human and environmental health. Expanding the synthetic raw material and product base not only contributes significantly to the cosmetic product range, but also consumer demand for natural and organic cosmetic products is increasing day by day. Cosmetics companies focus on such new technologies because they have high biological value and are environmentally friendly, and they especially search for alternative raw material sources with herbal extracts. The trends of the cosmetics industry require the use of ingredients of plant origin with multifunctional properties and long-lasting action. From retail to luxury stores, from online shopping to salons, there is a huge increase in interest and sales on products that include such features (Harhaun et al., 2020; Srinivasan & Antignac, 2011).

In addition to the use of plant extracts, especially medicinal and aromatic plants, in cosmetic products, studies have been carried out recently on the evaluation of agricultural wastes. For example, arbutin, one of the pruning wastes of Japanese pear trees, which is an important orchard crop in Japan, is commonly added to formulas for skin whitening and new cosmetics are developed. Successful commercialization of such products is important for the financial sustainability of the farmers and for the local environment. At the same time, it is important to identify the opinions, purchasing motives and perceptions of potential consumers in the cosmetics market, which is becoming more and more competitive with each passing day, to offer new products to the market, to create market opportunities and to analyze the situations.



In some marketing statistics made in this direction, it has been determined that products that do not contain fragrances/preservatives, do not contain irritants, contain only natural ingredients, are more preferred, and are seen as luxury products due to their high prices and limited availability, according to some consumer groups. However, in line with the adaptation of the concept of sustainability to every field, herbal and natural products have started to appeal to many segments of the public in terms of price (Yano et al., 2018).

## CONCLUSION

Medicinal and aromatic plants are plants that contain unique active ingredients for centuries in many industrial areas, can change physiological and pathological processes, and can be used to prevent or treat diseases, and have their own characteristic taste and odor properties. In this direction, the plants used as medicinal and aromatic, which are frequently used in areas such as cosmetics and food, and which have plant species that can exhibit different biological activities, gain even more importance with the concepts of increasing sustainability and nature-friendly products.

As personal care has a great place today as it was in the past, and consumers are becoming more and more conscious, cosmetic companies focus on new technologies with natural ingredients because they have high biological value and are eco-friendly, and they especially search for alternative raw material sources with herbal extracts. Accordingly, it is seen that many medicinal and aromatic plant essences have an important role in cosmetics, and it is known that people take place as a determining criterion in product selection.

In this study, medicinal and aromatic plant species that are widely used and grown in the world and in Turkey have been investigated, and research has been carried out on their classification, usage areas, active ingredients, and evaluation in the cosmetic sector.

## REFERENCES

- Aburjai, T. & Natsheh, F. M. (2003). Plants used in cosmetics. *Phytotherapy Research*, 35 (11), 987-1000.
- Aslan, R. & Karakuş, Z. (2019). Medicinal and aromatic plants from tradition to present. *Lakes Region Monthly Peer-Reviewed Economy and Culture Magazine*, 6 (73), 60-66.
- Atilabey, M. F., Yüksel, B., Uzunoğlu, T. & Oral, E. (2015). Medicinal and aromatic plants sector report, 11-31.
- Badi, K. A. & Khan, S. A. (2014). Formulation, evaluation, and comparison of the herbal shampoo with the commercial shampoos. *Beni-Suef University Journal of Basic and Applied Sciences*, 3 (4), 301-305.
- Bezerra, K. G. O., Silva, I. G. S., Almeida, F. C. G., Rufino, R. D. & Sarubbo, L. A. (2021). Plants-derived biosurfactants: Extraction, Characteristics and Properties for Application in Cosmetics. *Biocatalysis and Agricultural Biotechnology*, 34, 102036.
- Bom, S., Jorge, J., Ribeiro, H. M. & Marto, J. (2019). A step forward on sustainability in the cosmetics industry: A Review. *Journal of Cleaner Production*, 225, 270- 290.
- Busari, I. O., Soetan, K. O., Aiyelaagbe, O. O. & Babayemi, O. J. (2021). Ethnoveterinary study of plants used by fulani agropastoralists for treating livestock diseases in Ido agrarian community of Oyo State, Nigeria. *Acta Ecologica Sinica*, 41, 560-565.
- Faccio, G. (2020). Plant complexity and cosmetic innovation. *iScience*, 23 (8), 101358.
- Franz, C., Baser, K. H. C. & Windisch, W. (2009). Essential oils and aromatic plants in animal feeding- a european perspective. *Flavour and Fragrance Journal*, 25 (2), 327-340.
- Ganaie, H. A. (2020). Review of the active principles of medicinal and aromatic plants and their disease fighting properties. T. Aftab & K. R. Hakeem. (Ed.), *Medicinal and aromatic plants expanding their horizons though omics*, 1, 1-36. Academic Press: USA.
- Giannenas, I., Sidiropoulou, E., Bonos, E., Christaki, E. & Florouou-Paneri, P. (2020). The history of herbs, medicinal and aromatic plants, and their extracts: Past, current situation and future perspectives. P. Florou- Paneri, E. Christaki ve I. Giannenas, (Ed.), *Feed additives: Aromatic plants and herbs in animal nutrition and health*, 1-18. Academic Press: USA.
- Harhaun, R., Kunik, O., Saribekova, D. & Lazzara, G. (2020). Biologically active properties of plant extracts in cosmetic emulsions. *Microchemical Journal*, 154, 104543.
- Lochhead, R. Y. (2017). Basic physical sciences for the formulation of cosmetic



- products. *Cosmetic science and technology*, 1, 39-76. Elsevier: Hollanda.
- Lubbe, A. & Verpoorte, R. (2011). Cultivation of medicinal and aromatic plants for specialty industrial materials. *Industrial Crops and Products*, 34 (1), 785-801.
- Miquel, M. G. (2010). Antioxidant activity of medicinal and aromatic plants. *Flavour and Fragrance Journal*, 25 (5), 291-312.
- Mutlu, M. (2020). Development of Personalized Oral Care and Cosmetic Products Using Medicinal and Aromatic Plants. Duzce University, Graduate School of Natural and Applied Sciences, Duzce.
- Piccaglia, R., Marotti, M., Gioanelli, E., Deans, S. G. & Eaglesham, E. (1993). Antibacterial and antioxidant properties of mediterranean aromatic plants. *Industrial Crops and Products*, 2 (1), 47-50.
- Prabhu, K. H. & Bhute, A. S. (2012). Plant based natural dyes and mordants: A Review. *Journal of Natural Product and Plants Resources*, 2 (6), 649-664.
- Saleem, H., Khurshid, U., Sarfraz, M., Ahmad, I., Alamri, A., Anwar, S., Alamri, A. S., Locatelli, M., Tartaglia, A., Mahomoodally, M. F., Abidin, S. A. Z. & Ahemad, N. (2021). Investigation into the biological properties, secondary metabolites composition, and toxicity of aerial and root parts of *Capparis Spinosa L.*: An important medicinal food plant. *Food and Chemical Toxicology*, 155, 112404.
- Serencam, H., Gül, V., Gıdık, B. & Sefalı, A. (2018). Some *Salvia L.* species and essential oil contents. B. Gıdık, (Ed.), *Medicinal and Aromatic Plants: Essential Oil Plants*, 1, 5-21. İksad Publishing: Adıyaman.
- Souto, A. L., Sylvestre, M., Tölke, E. D., Tavares, J. F., Barbosa-Filho, J. M. & Cebrian-Torrejon, G. (2021). Plant-derived pesticides as an alternative to pest management and sustainable agricultural production: Prospects, applications, and challenges. *Molecules*, 26 (16), 4835, 1-34.
- Srinivasan, V. & Antignac, E. (2011). The safety assessment of plant-derived ingredients in cosmetics. N. Dayan & L. Kromidas, (Ed.), *Formulating, packaging, and marketing of natural cosmetic products*, 1, 123- 147. Wiley: New York.
- Tadros, T. F. (2005). Surfactants in personal care and cosmetics. *Applied surfactants: Principles and applications*, 1, 399-432. Wiley-VCH: Germany.
- Taroncher, M., Vila-Donat, P., Tolosa, J., Ruiz, M. J. & Carraso, Y. R. (2021). Biological activity and toxicity of plants nutraceuticals: An overview. *Current Opinion in Food Science*, 42, 113-118.
- Tong, W., Kerbler, M. S., Fernie, A. R. & Zhang, Y. (2021). Plant cell cultures as heterologous bio-factories for secondary metabolite production. *Plant Communications*, 2 (5), 1-12.
- Türedi, E. (2021). Evaluation of Medicinal Aromatic Plant Species in the Cosmetics Industry. Yildiz Technical University, Undergraduate Thesis, Istanbul.
- Van Wyk, B. E. & Wink, M. (2017). Traditional Chinese medicine. *Medicinal plants*

*of the world*, 2, 9-14. CABI Publishing: UK.

Yano, Y., Kato, E., Ohe, Y. & Blandford, D. (2018). Examining the opinions of potential consumers about plant- derived cosmetics: An approach combining word association, co- occurrence network, and multivariate probit analysis. *Journal of Sensory Studies*, 34 (2), e12484.

Yipel, F. A. & Yipel, M. (2014). Ethnoveterinary Medicine. *Journal of the Turkish Veterinary Medicine Association*, 14 (1-2), 79-82.



**CHAPTER 7**

**DESIGN OPTIMIZATION OF DISCONE  
ANTENNA USING META-HEURISTIC  
OPTIMIZATION**

*Serdal KARAHAN<sup>1</sup>  
Peyman MAHOUTI<sup>2</sup>*

---

1 Assist. Prof., İstanbul university Cerrahpaşa, Department of electronic and Automation

2 Assoc. Prof., Yıldız Technical university, Department of Avionics Orcid ID: 0000-0002-3351-4433

## Introduction

Thanks to the developing technology, the world has become a place that is interconnected within itself. When the data transfer is done with a cable, the overall data transfer becomes more difficult and the cost increases accordingly between long distances. In addition, pulling long cable lines requires good protection from environmental factors, and requires a regular maintenance which would significantly increase the cost of the data transfer operation. Today, antennas have become a subject that needs to be studied due to the need for communication and the importance of transmission speed with high speed and low cost. They are produced in different sizes and shapes according to the desired purpose and the characteristics of the location. The main purpose of the antenna design is to transmit the signal to the receiver without any loss. Therefore, the design of the antenna stage is an important study case which must be handled with respect to the requirements of application such as distance of the transmission, operation frequency and additional requirements such as size and dimensions [1].

Wideband (WB) and Ultra-Wideband (UWB) antennas play an important role in modern wireless communication [2-10]. However, WB antennas have gradually started to be replaced by UWB antennas due to their relatively large size. The wide frequency range of UWB antennas provides convenience in multi-channel system applications, and this has increased the interest in UWB antenna designs. However, design of such antenna stages requires an expert knowledge on the determination of design variables where variation in any of the design variables can create an impact on the overall performance of antenna stage either in a good or bad way. Furthermore, although variation in a single variable might improve one of the antenna characteristics such as operation band, it might also significantly drop another performance characteristics such as directivity for the same or another operation frequency. Thus, this leads designer to a Pareto-front problem where designer must make a choice to achieve an overall optimal design variable sets to achieve all the requirements of the antenna design. This problem can be defined as a multi-objective multi dimension optimization problem.

Meta-heuristic optimization algorithms, had shown great potential in the last decades for design optimization of many different multi-objective multi dimensions problems [11-14]. The unique features of these algorithms that usually is inspired from the behaviour of animals, insect or other creatures creates an efficient search protocol for mentioned problems. One of the research fields that use meta-heuristic optimization algorithms to obtain high performance designs is microwave and RF engineering. For the last decades, meta-heuristics algorithms had been used for design optimization of different microwave and RF stages such as Dipole antenna, Microstrip

antenna, Antenna arrays such as reflectarrays, microwave filter, matching networks and etc [15-18].

Herein, discone antenna, which is a one of the commonly used UWB antenna types is taken under study to be optimally designed using meta-heuristic optimization algorithms. For this work a population based meta-heuristic optimization algorithm is taken under study. Honey Bee Mating (HBMO) [19-22]: which is a meta-heuristic search protocol that is inspired from the mating of honey bees. The Queen of the Bee colony lays eggs as a result of mating flight with drone bees to increase the population of the colony. The new born female members of the hive are taken care by the nurse bees and in case of a new born with better fertility potential than the current Queen bee, this new born becomes the Queen of the hive in order to give birth to members with better fitness due to its better potential than the previous Queen.

The flow diagram of the proposed design optimization of Discone antenna with meta-heuristics optimizers is presented in Fig. 1. For calculation of EM performance of antenna stage, full wave EM simulation tools is used. In the next section the overall design of the Discone antenna will be discussed after that in section III, the design optimization process and its simulated results will be presented. Finally the work ends with a brief conclusion in section IV.

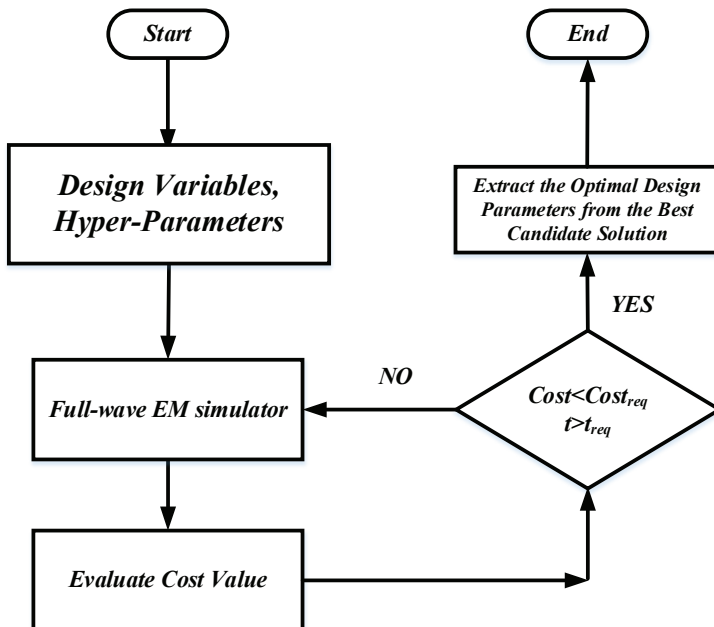


Fig. 1. Flow chart of the optimization process for Discone antenna.

## Discone Anten

In recent years, with the development of Ultra-Wide Band (UWB) system technology, there has been an increase in studies in the field of communication. With the allocation of the 3.1 GHz and 10.6 GHz frequency ranges by the United States regulatory agency (Federal Communication Commission-FCC) for the use of Ultra-Wide Band systems, UWB studies have also gained a momentum. Again, in the statement made by the same organization, the definition of UWB is explained as “the situation where the frequency bandwidth where  $S_{11}(\text{dB}) < -10\text{dB}$  is more than 25% to the center frequency” [2]. In addition to working in wide frequency ranges, UWB antennas are designed with linear phase response, allow high speed data transfer with minimum distortion, low power requirement and low production costs have made UWB antennas popular in military and civilian areas [3]. Discone antennas have become the most studied and researched antenna in UWB systems due to their relatively small size omnidirectional radiation characteristic [4]. Discone antennas are frequently preferred in the GSM (Global System for Mobile Communications) sector today due to their ability to radiate at different angles [5]. The discone antenna generally consists of a disk placed horizontally on a cone. These two main components can be designed in various shapes and sizes and can also be used with additional fasteners. The disc and cone part are usually produced from a metal part, but this production can cause difficulties in places where the wind load is intense, so these two parts can also be designed using metal rods [6].

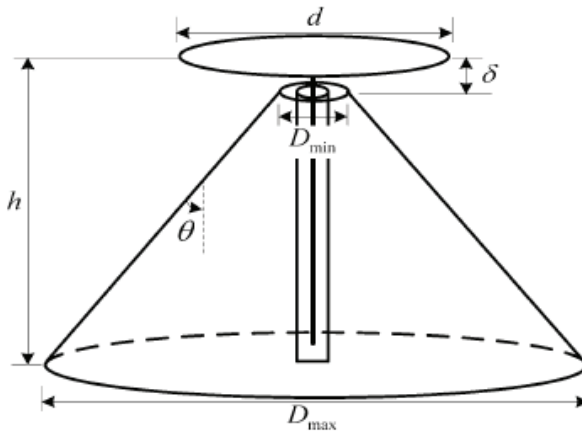


Figure 2. Parts of a discone antenna [7]

Since the primary usage areas of Discone antennas are commercial and military areas, there may be various changes in the structure according to the needs. However, these applications require an antenna structure with a high gain. Therefore, in order to improve the structure (to create a new Wide

Bant antenna), it is necessary to make new additions to the antenna. If large size reductions are required, the following three features should be added to the antenna to avoid wavelength reduction: 1. Adding a back cavity surrounding the cone. 2. Putting a short-circuit metal layer between the base (or ground) of the cone and the circle. 3. Adding a new circular layer to the top circular layer. If it is desired to reduce the dimensions of the discone antenna without using additional elements, it is necessary to change the parameters as little as possible, otherwise there will be a decrease in the bandwidth [7]. Many studies have been carried out on different models of Discone antennas. Figure 1. The discone antenna, seen in (a) and operating in the 200MHz-447MHz frequency band, is designed to take up less space in places with small volumes, and the above-mentioned “3” parameter has been added to the antenna since the size has been reduced [7]. A double cylindrical wire discone antenna(b), designed in the 180MHz-18GHz operating frequency range, is considered to be operating in the 12GHz frequency band with omni-directional radiation characteristics and is used for UWB frequency scanning [4]. A discone antenna(c), whose disc part is spirally designed, is designed for indoor GSM communication in two different frequency ranges (650MHz-3GHz, 1.27GHz-3GHz) [8]. The skeletal discone antenna seen in Figure 1.(d) has omni-directional radiation characteristics and operates in the frequency range of 1.47 GHz to 16.48 GHz [9].

### Study Case

In Fig. 3, the schematic and 3D view of the Discone antenna is presented. Here it should be noted that following criteria's can be considered to obtain an optimal Discone antenna design with respect to the required performance criteria's. To increase the operating frequency, the dimensions of design can be reduced, to reduce the ripple in the reflection coefficient, the flare angle should be increased, and with reducing the minimum cone diameter and feed gap the input impedance can be improved. The design variables presented in Figs. 3 (a)-(b) are defined in a search space defined in Table 1. The HBMO algorithm is used to make a search in the defined search space to obtain optimal geometrical design values to satisfy the following cost function that is defined in Eqs. (1-3)

$$\mathbf{x}^* = \arg \min_{\mathbf{x}} [w_1 C_1(\mathbf{x}) + w_2 C_2(\mathbf{x})] \quad (1)$$

$$C_1(\mathbf{x}) = \max \{ f \in [f_{c1}, f_{c2}] : |S_{11}(\mathbf{x}, f)| \} \quad (2)$$

$$C_2(\mathbf{x}) = \max \{ f \in [f_{c1}, f_{c2}] : Directivity(\mathbf{x}, f) \} \quad (3)$$

Here  $C_i$  is the cost function terms for scattering parameter and directivity separately,  $x$  is the input vector for design variables,  $fc1$  and  $fc2$  denote the lower and upper frequency determining the target operating band.  $w1$  (0.7) &  $w2$  (0.3) are weighing coefficient of each terms. The balance of the coefficient should be taken with extra care due to the possibly huge difference between  $S_{11}$ , and directivity in means of their max magnitude values.

In Table II, optimally determined Discone Antenna's design variables using HBMO search protocol parameters are given. These values are obtained after 20 iterations with following hyper-parameters, Number of Drone bees=25, and Royal jelly step size =  $\pm 0.1$  using HBMO optimization [30]. Here, the main aim of optimization is to obtain an ultra-wide band performance over the frequency range of 1.5 to 10 GHz with a highest possible radiation gain over the mentioned operation range. The simulated performance results of the optimally designed Discone antenna is presented in Fig. 4.

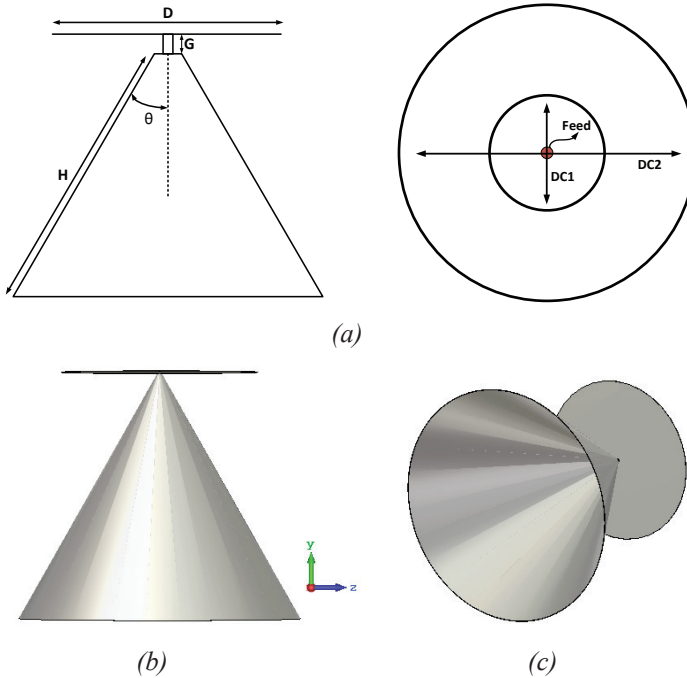


Figure 3. (a) Schematic, (b) side, (c) perspective, view of the studied Discone antenna

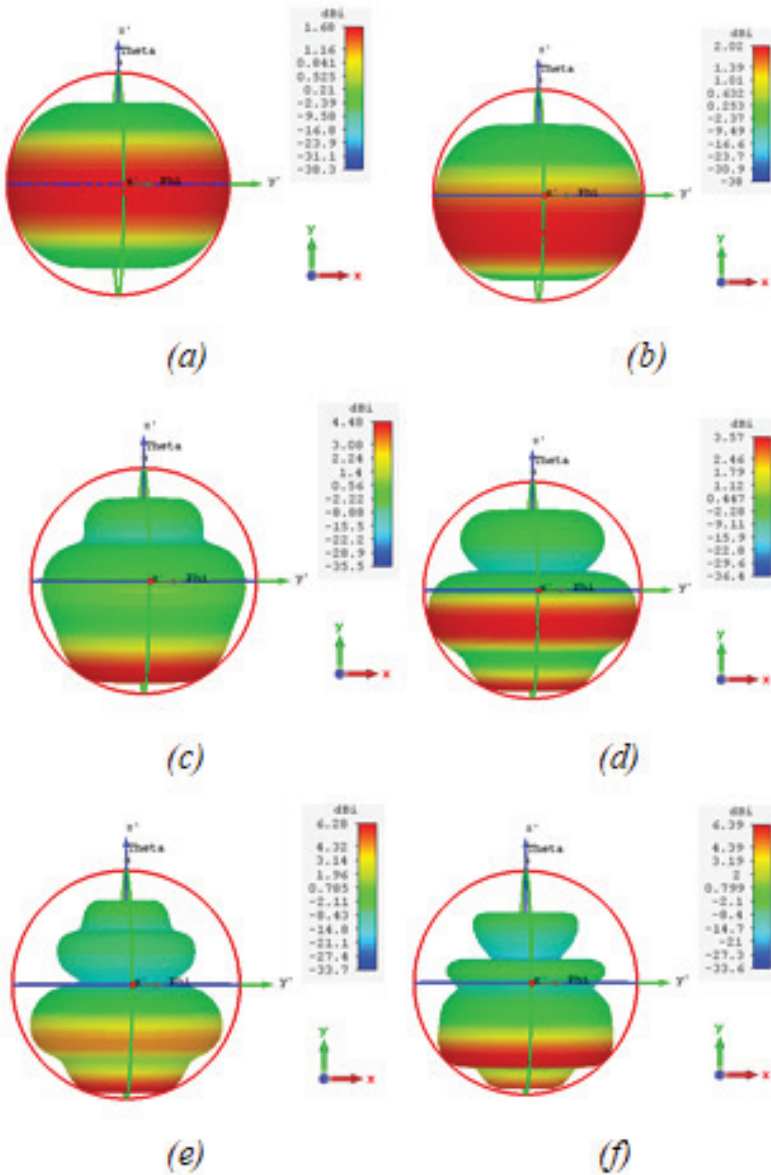
Table 1. Defined search space of Discone antenna's design variables [Minimum - Maximum limits]

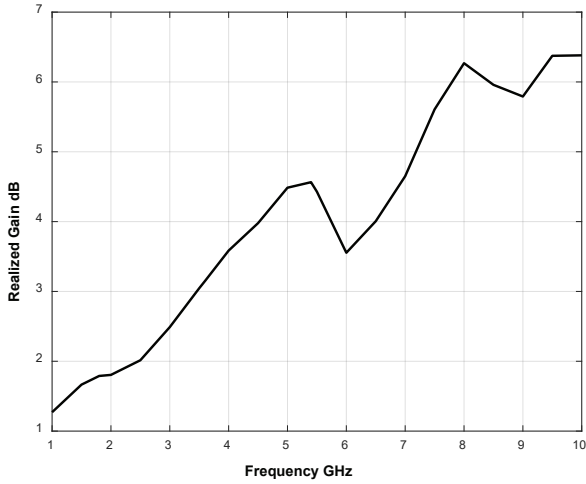
$DC1$ [mm]	20-50	$H$ [mm]	10-1003
$DC2$ [mm]	40-80	Theta [Degree]	10-80
$D$ [mm]	10-80	$G$ [mm]	0.1-1.5



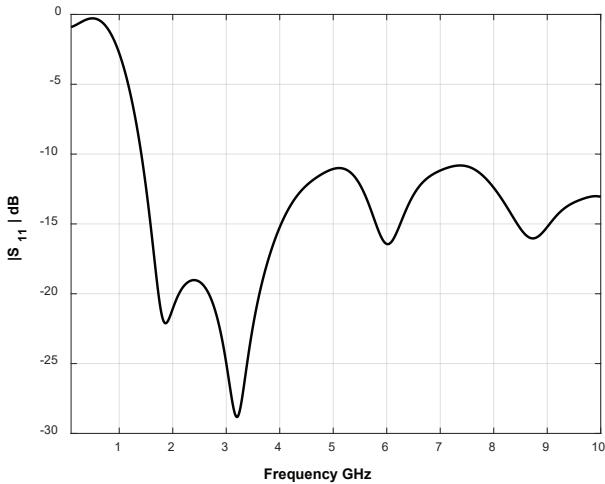
Table 2. Optimally determined Discone Antenna's design variables using HBMO search protocol

$DC1$ [mm]	41.4	$H$ [mm]	59.3
$DC2$ [mm]	59.2	$\theta$ [Degree]	29
$D$ [mm]	41.4	$G$ [mm]	0.3





(g)



(h)

Figure 4. Simulated radiation pattern characteristics of the optimally designed discone antenna at (a) 1.5 GHz, (b) 2.5 GHz, (c) 5 GHz, (d) 6 GHz, (e) 8GHz, (f) 10 GHz, simulated (g) gain, and (h), scattering performance over the frequency.

As it can be seen from simulated results in Fig. 4, the obtained geometrical design parameters in Table 2, via the HBMO search protocol, had achieved the requested performance criteria's where an overall high radiation performance which are shown in Figs. 4 (a-g) both in 3D far field radiation and max gain variation over the frequency range, alongside of the simulated scattering parameter that achieves S11 characteristic of less than -10 dB over the aimed operation range of 1.5-10 GHz.

## Conclusion

As it mentioned before, Ultra-Wideband (UWB) antennas play an important role in modern wireless communication. However, design of such antenna stages requires an expert knowledge on the determination of design variables where variation in any of the design variables can create an impact on the overall performance of antenna stage either in a good or bad way which leads designer to a Pareto-front problem where designer must make a choice to achieve an overall optimal design variable sets to achieve all the requirements of the antenna design. This problem can be defined as a multi-objective multi dimension optimization problem. Herein, Honey Bee Mating (HBMO) a meta-heuristic search protocol that is inspired from the mating of honey bees is used for optimal determination of design variables of Discone antenna with help of a full-wave EM simulation tool.

As it can be seen from simulated results, the obtained geometrical design parameters using HBMO search protocol, had achieved a very good performance results for the studied antenna design even for the challenging design optimization problem of an ultra-wide band antenna with high gain performance. Thus, it can be concluded that application of Meta-Heuristic optimization algorithms for design optimization of UWB band and high gain antenna with the help of Full-wave EM simulators is an efficient method for these problems. In future works it is aimed to further improve the computation efficiency of this process via the use of Deep Learning algorithms to create a data driven surrogate models of full-wave EM simulators to reduce the overall optimization duration.

## Acknowledgment

We would like to express our special thanks of gratitude to the Aktif Nesor Elektronik and DataRobot, for providing researcher licenses for CST and DataRobot.

## REFERENCES

- [1] Mahouti, Peyman. "Design optimization of a pattern reconfigurable microstrip antenna using differential evolution and 3D EM simulation-based neural network model." *International Journal of RF and Microwave Computer-Aided Engineering* 29, no. 8 (2019): e21796.
- [2] Kuşulay İ. Toktaş A. (2019) C ve X-Bant Uygulamaları İçin Kompakt Ultra Geniş Bant Dirgen Şekilli Mikroşerit Anten Tasarımı Conference Paper 2019:405
- [3] Qing X. Chen Z. ve Chia M. (2005) UWB Characteristics of Disc Cone Antenna Institute for HFOCOTNM Research IWAT 2005. IEEE International Workshop on Antenna Technology 2005:97
- [4] Kim K. Kim J.ve Park S. (2005) An Ultrawide-Band Double Discone Antenna With the Tapered Cylindrical Wires Ieee Transactions on Antennas and Propagation, vol. 53, no. 10, 2005:3403
- [5] Zhang Y. ve Brown A.K. (2006) The Discone Antenna in a BPSK Direct-Sequence Indoor UWB Communication System Ieee Transactions on Microwave Theory and Techniques, vol. 54, no. 4 2006:1675
- [6] Wei Y. Ai-xin C. Tie-hua J. (2010) Design of UHF miniature discone antenna Proceedings of the 9th International Symposium on Antennas, Propagation and EM Theory 2010:356
- [7] Chen A. Tiehua Jiang T. Chen Z. Su D. Wei W. ve Zhang Y. A Wideband (2011) VHF/UHF Discone-Based Antenna Ieee Antennas and Wireless Propagation Letters, vol. 10. 2011:450
- [8] Januszkiewicu L. Hausman S. Combined Spiral-Discone Broadband Antenna For Indoor Applications (2004) IEEE 15th International Symposium on Personal, Indoor and Mobile Radio Communications
- [9] Yuanqing Z. ve Wei W. Design of a Novel Broadband Skeletal Discone Antennawith a Compact Configuration (2014) IEEE Antennas and Wireless Propagation Letters 2014:1725
- [10] Sevinç A. A., Mahouti P., Belen M. A., "yapay sinir ağı kullanılarak discone anten tasarımı", *Mühendislik Alanında Teori ve Araştırmalar, Gece Kitaplığı*, 2020.
- [11] Tafakkori, K., Tavakkoli-Moghaddam, R., & Siadat, A. (2022). Sustainable negotiation-based nesting and scheduling in additive manufacturing systems: A case study and multi-objective meta-heuristic algorithms. *Engineering Applications of Artificial Intelligence*, 112, 104836.
- [12] Abbaszadeh Shahri, Abbas, Mohammad Khorsand Zak, and Hossein Abbaszadeh Shahri. "A modified firefly algorithm applying on multi-objective radial-based function for blasting." *Neural Computing and Applications* 34, no. 3 (2022): 2455-2471.

- [13] Samarthrao, Kadam Vikas, and Vandana M. Rohokale. "A hybrid meta-heuristic-based multi-objective feature selection with adaptive capsule network for automated email spam detection." *International Journal of Intelligent Robotics and Applications* (2022): 1-25.
- [14] Tilva, Surbhi, and Jayesh Dhodiya. "Developing a Meta-Heuristic Method for Solving Multi-objective COTS Selection Problems." In *Mathematical Modeling, Computational Intelligence Techniques and Renewable Energy*, pp. 285-297. Springer, Singapore, 2022.
- [15] Belen, A., Tari, O., Mahouti, P., Belen, M. A., & Çalışkan, A. (2022). Surrogate-Based Design Optimization of Multi-Band Antenna. *The Applied Computational Electromagnetics Society Journal (ACES)*, 34-40.
- [16] Misra, B., & Mahanti, G. K. (2022). Meta-heuristic optimization algorithms for synthesis of reconfigurable hexagonal array antenna in two principle vertical planes. *International Journal of Microwave and Wireless Technologies*, 14(2), 158-165.
- [17] Singh, Rashwinder, and Ranjit Kaur. "A Novel Archimedes Optimization Algorithm with Levy Flight for Designing Microstrip Patch Antenna." *Arabian Journal for Science and Engineering* 47, no. 3 (2022): 3683-3706.
- [18] Çalışkan, Alper, and Filiz Güneş. "3D EM data-driven artificial network-based design optimization of circular reflectarray antenna with semi-elliptic rings for X-band applications." *Microwave and Optical Technology Letters* 64, no. 3 (2022): 537-543.
- [19] Fathian, M., Amiri, B., & Maroosi, A. (2007). Application of honey-bee mating optimization algorithm on clustering. *Applied Mathematics and Computation*, 190(2), 1502-1513.
- [20] Afshar, Abbas, O. Bozorg Haddad, Miguel A. Mariño, and Barry J. Adams. "Honey-bee mating optimization (HBMO) algorithm for optimal reservoir operation." *Journal of the Franklin Institute* 344, no. 5 (2007): 452-462.
- [21] Güneş, Filiz, Salih Demirel, and Peyman Mahouti. "Design of a front-end amplifier for the maximum power delivery and required noise by HBMO with support vector microstrip model." *Radioengineering* 23, no. 1 (2014): 134-143.
- [22] Güneş, F., Demirel, S., & Mahouti, P. (2016). A simple and efficient honey bee mating optimization approach to performance characterization of a microwave transistor for the maximum power delivery and required noise. *International Journal of Numerical Modelling: Electronic Networks, Devices and Fields*, 29(1), 4-20.





## ***CHAPTER 8***

### **APPLICATION OF HEAT TREATMENT PROCESS TO AISI 2080 STEEL**

*Halil Ibrahim KURT<sup>1</sup>  
Hatice Ozge ALAGOZ<sup>2</sup>,  
Hanim KAYA<sup>3</sup>  
Utku Berk AKYUZ<sup>4</sup>,  
Damra Nisa DAL<sup>5</sup>  
Okan SERT<sup>6</sup>*

---

1 Aerospace Engineering, Faculty of Aeronautics and Astronautics, University of Samsun, Turkey 0000-0002-5992-8853

2 Department of Metallurgical and Materials Engineering, Engineering Faculty, Gaziantep University, Turkey ozggealagoz@gmail.com

3 Department of Metallurgical and Materials Engineering, Engineering Faculty, Gaziantep University, Turkey

4 Department of Metallurgical and Materials Engineering, Engineering Faculty, Gaziantep University, Turkey

5 Department of Metallurgical and Materials Engineering, Engineering Faculty, Gaziantep University, Turkey

6 Department of Metallurgical and Materials Engineering, Engineering Faculty, Gaziantep University, Turkey

## 1. Introduction

### 1.1. Overview

Iron like many metals is found in the earth's crust only in the form of ores combined with other elements such as oxygen and sulfur. Among the minerals contained in standard iron, there are iron oxide ( $\text{Fe}_2\text{O}_3$ ) which is a mineral sprout consisting of natural iron oxide that has a dark color and  $\text{FeS}_2$  pyrite. Iron is removed from the ore by removing oxygen and combining it with carbon the chemically preferred partner of the ore. This process is first applied to metals with low melting points, such as tin (approximately melting point  $250\text{ }^\circ\text{C}$  ( $482\text{ }^\circ\text{F}$ )) and copper (approximately melting point  $1.000\text{ }^\circ\text{C}$  ( $1.830\text{ }^\circ\text{F}$ )) and is known as the mine liquidation process. If a comparison is made, it can be seen that cast iron melts at about  $1.370\text{ }^\circ\text{C}$  ( $2.500\text{ }^\circ\text{F}$ ). It is possible to reach all these temperatures using the old methods applied since the Bronze Age. Since the oxygen rate itself quickly increases to around  $800\text{ }^\circ\text{C}$ , it is important that the mine liquidation process takes place in a low oxygen environment. Liquid iron, unlike copper and copper, easily dissolves carbon. The mine liquidation process results in a high carbon-containing alloy called steel as pig iron. The excess carbon and other additives are removed in the next step. Although steel is produced by various ineffective methods long before the Renaissance, Its use became widespread after more effective productions invented in the XIII century. In the middle of the XIX century, with the invention of the Bessemer modifier, steel began to become an inexpensive mass-production material. Improvements such as steelmaking with basic oxygen added in the process of progress have reduced the cost of production and improved the quality of the metal (Bugayev, Tretyakov, & Savin, 2001).

Steel is an alloy consisting of the composition of the element iron and the amount of carbon, which usually varies from 0.02 to 2.1 wt.%. The amount of C in the steel alloy plays an important key in the steel grading. Although C is the alloying element of iron, various elements like Mg, Cr, and V can also be used. The C and other elements play the role of a hardening element by avoiding the crystal laths in the atom from sliding and passing each other. It controls properties such as hardness, ductility and stress point in steel consisting of varying amounts of the elements in the lattices and the forms that they are present (solute elements, precipitation stage). Steels with a high amount of carbon have a high hardness and are stronger than iron, they are less ductile. Two distinctive factors also increase the rust resistance of steels and provide better weldability. Today, with a production of 1300 million tons every year, steel is one of the most used common materials in the world. It is the main material in buildings, infrastructure production, tools, ships, cars, machinery, accessories and weapons. Modern steel is classified according



to various specifications by various standards organizations. There are four main groups of steel alloys. These are

- **Carbon Steel**
- **Tool Steel**
- **Alloy Steel**
- **Stainless Steel**

Steel is very widely used due to its specific material properties and relatively low cost. Compared to many other construction and tool-making materials (such as wood, stone, concrete or cast iron), steel alloys have the excellent properties like hardness, toughness, yield strength, tensile strength, malleability and ductility (Russell & Vaughn, 2013).

### **1.2. The 2080 steel**

The 2080 steel (1.2080; CP10V; D3) is a cold work tool steel with a 12% chromium and a ledeburitic structure. The steel is a highly wear-resistant tool steel that can be hardened in oil, containing high carbon and chromium. It is also a material with high strength and capable of taking hardness in depth. It is resistant to corrosive and adhesive abrasion due to the presence of dense hard carbide in it. Due to its resistance to tensile stresses and low toughness, it has been replaced by other steels according to its field of use. For example, CPW (2436) and CPR steels can be considered if wear resistance is at the forefront, and CPPU (2379) and WP7V steels can be considered if toughness is also required. The steel can be used in industrial knives, cutting tools, cold forging molds, wood cutting knives, roll form molds, rolling rollers, gauge tools and measuring tools (Nayar, 2000).

### **2. Heat Treatment**

Heat treatment is called a series of heating and cooling processes by applying a certain temperature to change the properties and internal structure of a material and change the properties and chemical structure of that material to make it suitable for the process in which it will be used (Prabhudev, 1988).

In terms of heat treatment properties, it can be divided into two classes as annealing and hardening. The properties of steel materials are given characteristics depending on the carbon and uptake rates contained in them and the area of use of the material (Totten & Howes, 1997). These features;

- Elimination of internal tensions,
- Hardening and tempering,
- High strength,

- Machinability,
- Compatible to the environment,
- Chemical durability,
- Provides electrical and magnetic properties.

Since steels are used more in industry than other metals and their alloys, the heat treatment of steels has a separate importance. In order to understand the heat treatment of steels, it is necessary to know the Iron-Cementite equilibrium diagram. The part of the Iron-Cementite phase diagram up to 2% C composition is the steel part. The desired structure to be obtained in a steel with a certain carbon composition, therefore, the property that the steel will acquire, is the ability to use the steel for different heat treatments in the steel part of the Iron- Cementite diagram. It is obtained by removing it to different temperature zones, holding it for a certain time and cooling it in the appropriate cooling environment. The heat treatment of steel is mainly applied for the following purposes:

1. Improves machinability (grain coarsening)
2. Strength increase, reduction (hardening, normalization, tempering)
3. Destroying the cold forming effect (recrystallization)
4. Elimination of micro-segregation (homogenization)
5. Grain size control (normalization, recrystallization, grain coarsening)
6. Internal stress relief (stress relief)
7. Changes in the internal structure (normalization, tempering, hardening)

### **2.1. Hardening**

Hardening is the annealing of materials to predetermined hardening temperatures, followed by cooling and making the hard tissue suitable for use. In the hardening process, it is desirable that the material has the highest possible degree of hardness and high strength

### **2.2. Tempering**

Heat treatment, which changes the physical and chemical properties of a material, reducing its hardness and making it more workable, is called annealing. It involves heating a material above the recrystallization temperature and maintaining the appropriate temperature for a while, followed by cooling. After forming applications (such as rolling, forging and cold forming), metals need an annealing process.

### **2.3. Softening Annealing:**

For easy processing of materials that have not been heat treated, their

hardness must be softened. It is especially important to reduce stiffness for replacement processes that are not like plastic. For this reason, softening annealing is performed on the materials to soften the materials.

#### **2.4. Stress Relief Annealing:**

In cases such as overheating or cooling of the material, welding, high stress may occur in the material. For this reason, stress relief annealing is performed in order to eliminate the brittleness of the parts and reduce the internal stresses.

#### **2.5. Recrystallization Annealing:**

The annealing is carried out in order to bring the properties of the material that has gained hardness during cold forming to the initial level. By this method, the material is recrystallized in a solid state without deterioration and the hardness formed during cold forming is eliminated.

#### **2.6. Normalization Annealing:**

As a result of the influence of high temperatures on the forged, rolled and welded parts, coarse-grained grains are formed. For this reason, fine-grained structure is the method applied to return the materials to their former state.

### **3. Heat Treatment of 2080 Steel**

The ability to process of the steel is 25% harder than carbon steels, but the raw material can be easily processed with ordinary tools.

#### **3.1. Softening Annealing**

The material is heated to 800-840 °C, cooled slowly. After this procedure, it is lowered to a maximum hardness of 250 HB.

#### **3.2. Stress Relief Annealing**

The purpose of stress relief annealing is to remove the stress carried by the parts that have been subjected to intensive mechanical treatment. The part is heated to 650 °C and left at this temperature for about 1 hour depending on the size, and then allowed to cool in the air. Thanks to this operation, distortions that may occur during heat treatment are also prevented.

#### **3.3 Hardening**

The first stage of the hardening process is heated to a temperature of 940-980 °C, and then cooled to 400 °C in an oil bath or hot bath. After

pre-hardening, the hardness reaches up to 63-65 HRC values. The pre-hardening temperature is 960-1000 °C for parts up to 30mm, and then it is cooled in air to reach a hardness of 63-65HRC.

### 3.4. Final Annealing

The tempering temperature in the range of 150-400 °C according to the desired hardness value and measurement variables.

## 4. Materials and Method

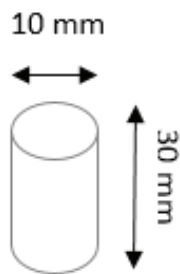
As the material, 2080 (CP10V) steel, which is a ledeburitic structured cold work tool steel containing 12% chromium, is used. The composition and some properties of the steel is given in Table 1 and Table 2. The material has a diameter of 10 mm and a height of 30 mm as shown in Fig. 1.

**Table 1.** *The chemical composition of 2080 steel*

Mat. No	AISI/SAE	C	Si	Mn	Cr	Fe
1.2080	D3	2.05	0.25	030	11.50	Rem.

**Table 2.** *The some properties of 2080 steel*

Young's Modulus	210 [1000 x N/mm <sup>2</sup> ]
Density	7.67 [g/cm <sup>3</sup> ]
Thermal conductivity	20 [W/m.K]
Electrical resistivity	0.65 [Ohm.mm <sup>2</sup> /m]
Specific heat capacity	0.46 [J/g.K]
Hardness	64-66 HRC after quenching



**Fig 1.** *The schematic drawing of samples*

The specimens are homogenized at 800 °C for 2 h in the furnace demonstrated in Fig. 2 and then quenched in the mixture of oil and water (50wt.%+50wt.%). After, the samples are tempered at 100, 200 and 300 °C for 1, 2 and 3 h. Table 3. indicates the experimental process detail.



**Fig 2.** Heat treatment furnace

**Table 3.** The experimental design

Code	Homogenization (°C)	Time (h)	Tempering (°C)	Time (h)
Sample 1	800	2	F	-
Sample 2	800	2	100	1
Sample 3	800	2	200	2
Sample 4	800	2	300	3

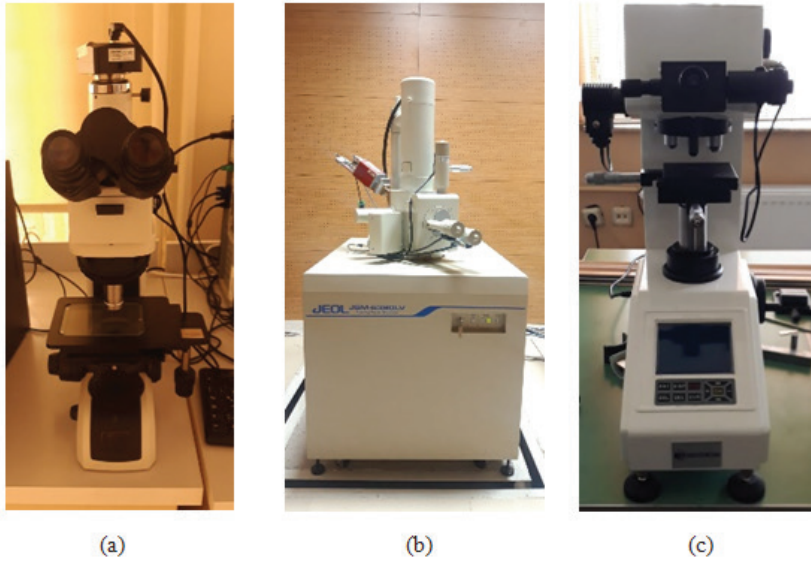
The heat treated samples are subjected to standard sanding and polishing process. Figure 3 represents the grinding and polishing device. The polished samples are etched in 1ml HNO<sub>3</sub> - 2ml HCl - 3ml glycerol solution for 25 minutes.



**Fig 3.** Grinding and polishing device

Microstructures are examined using the optics in Figure 4a and the scanning electron microscope in Figure 4b. The mechanical properties of

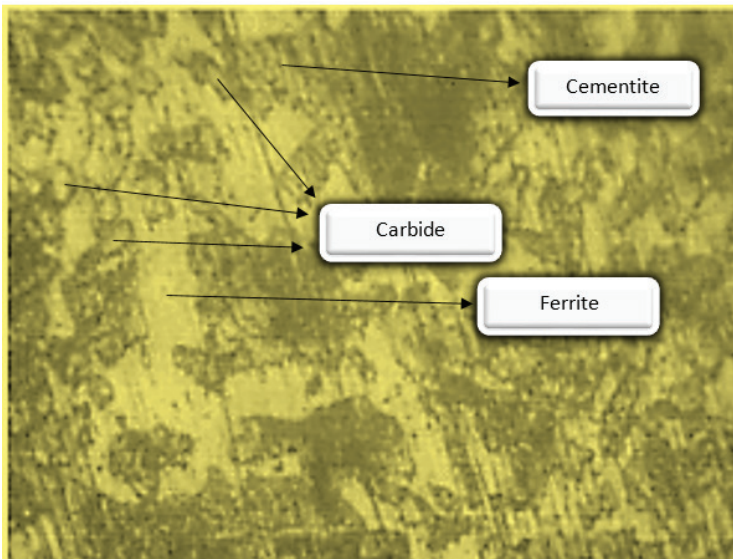
the samples are researched using the Vicker hardness test in Figure 4c. The Vickers hardness test is taken under a load of 1 kg with a 10 s loading time and the average of the 3 readings is presented.



**Fig 4.** a) *Optical microscope, b) SEM and c) Vickers hardness device*

## 5. Results

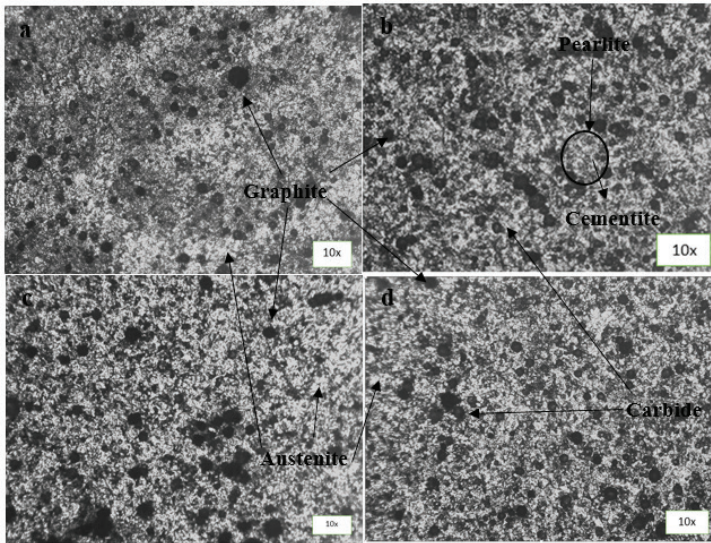
Fig. 5 shows the initial structure of 2080 steel. It is clear that the microstructure consists of chromium carbides and cementite in ferritic matrix.



**Fig. 5.** *Optical microscope image of untreated sample*

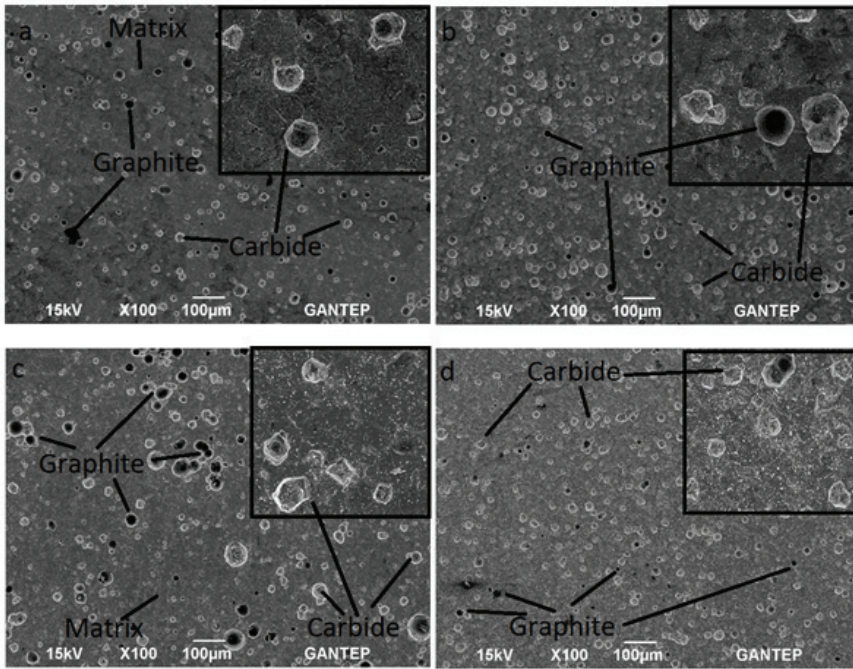


The optical microstructures and SEM images of heat treated samples are depicted in Figs. 6 and 7. Metallographic analysis revealed that the structure after heat treatment process consisted of globular grains of metastable phases surrounded by carbides and fine eutectics in ferritic matrix (Neslušan, Minárik, Čilliková, Kolařík, & Rubešová, 2019). The graphite's and carbides in SEM images can be easily seen. It is clear that the morphology of carbides changed after heat treatment process. The graphite's and carbides are observed to be spherical form and homogenous distribution in the matrix.

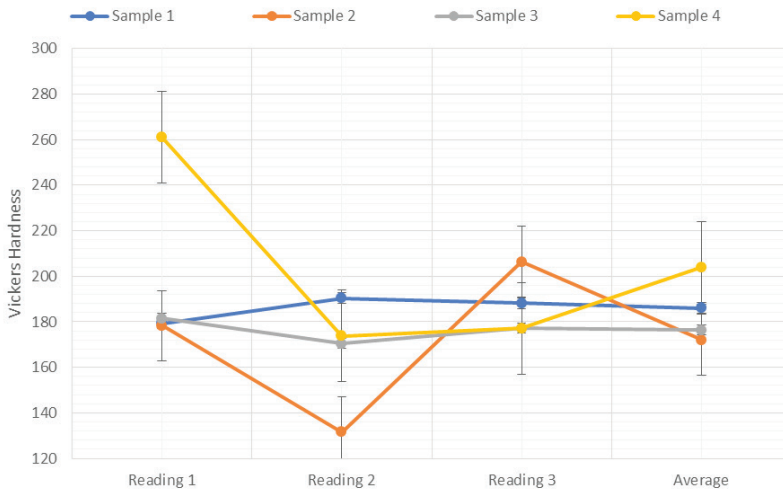


**Fig. 6.** Optical microscope images of a) sample 1 b) sample 2 c) sample 3 d) sample 4

Vickers hardness values of specimens are illustrated in Fig. 8. The averages of hardness values for samples 1, 2, 3 and 4 are 185, 172, 176 and 204, respectively. The maximum hardness is obtained at sample 4. In the figure, it can be seen a high hardness value for specimen 4 which can be attributed to hard carbide particles. Same results are also reported in literature (Geng, Li, Zhou, Wang, & Jiang, 2020).



**Fig. 7.** SEM images of a) sample1 b) sample 2 c) sample 3 d) sample 4



**Fig 8.** Vickers hardness of a) sample1 b) sample 2 c) sample 3 d) sample 4

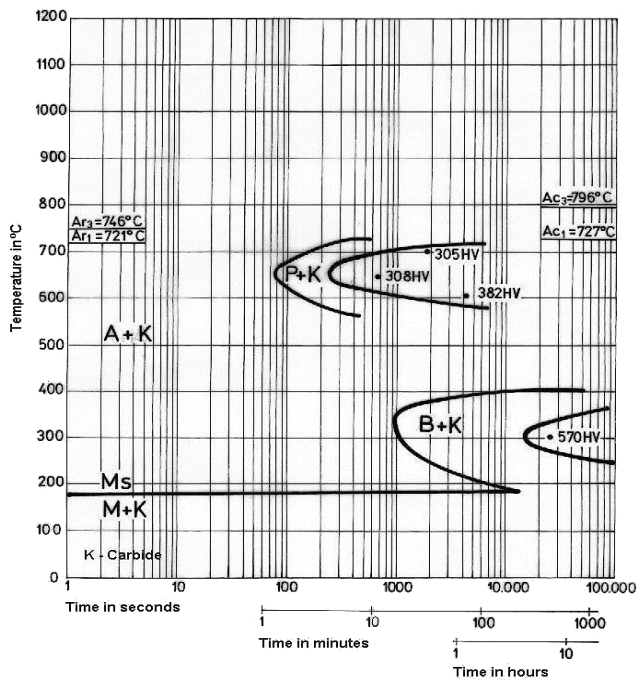
## 6. Discussion

In the microstructure of the untreated steel, non-uniform distribution



and longitudinal carbides and thin cementite's can be seen. Thanks to the heat treatment, non-homogeneous structure and distribution are homogenized and distributed. The homogeneous distribution of carbides contributed to hardness values of sample.

According to TTT diagram of 2080 steel in the given Fig. 9,  $A_{c3}$  temperature is  $796^{\circ}\text{C}$  ("Data Sheet," 2022). In this work, the temperature is exceed to carry out the homogenization process. After the process, the specimens are quenched in furnace and the mixture of oil and water (50wt.%+50wt.%). The microstructure is made up of cementite, pearlite pre-eutectic and carbides because full austenization is not achieved.



**Fig 9.** TTT diagram of C210Cr12 steel

According to CCT diagram of 2080 steel in the given Fig. 10,  $A_{c3}$  temperature is  $796^{\circ}\text{C}$ . In this work, the temperature is exceed to carry out the homogenization process. After the process, the specimens are quenched in furnace and the mixture of oil and water when samples are quenched from 800 degrees, the microstructure forms from pearlite pre-eutectic and carbides due to partial austenization. The wording A + C in this figure shows that a certain amount of carbides is always present. Also in the case of hyper-eutectoid steel, the alloying elements, as well as the increase in austenization

time and/or austenization temperature cause a shift to the right and bottom of the T.T.T. and C.C.T. diagrams, i.e. a delay in the austenite transformation (“Data Sheet,” 2022).

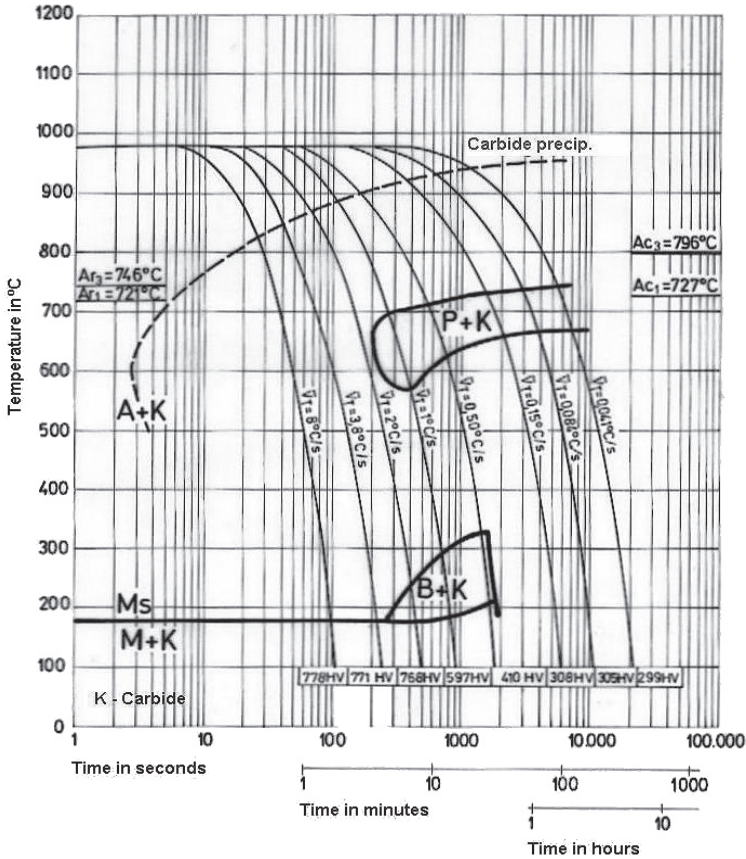
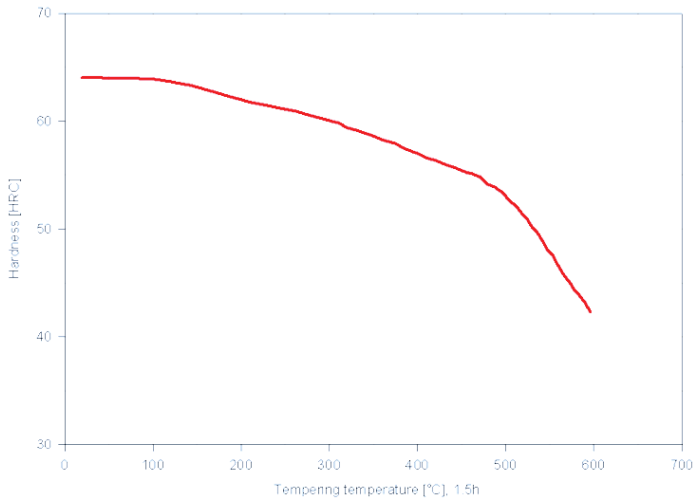


Fig 10. CCT diagram of C210Cr12 steel

The results corresponds to the high thermal stability of metastable phases in rapidly solidified powder particles from a Cr–Mo–V tool steel of ledeburite type prepared by nitrogen gas atomization (Grgac et al., 2004). The effects of tempering temperature on hardness is indicated in Fig. 11. The hardness value reduces with the increasing of the temperature. As seen in this work, the increase in tempering temperature affected the hardness value.



**Fig 11.** *Tempering-Hardness relationship*

## 7. Conclusion

In this study, 2080 steel is heat treated under the given condition. The structure and hardness results are researched and discussed. From obtained results, it is possible to declare the following conclusions;

Heat treatment process changed the microstructure and hardness values.

Carbides and graphite flakes displayed the homogenous distribution.

Sample 4 with about 204 Vickers hardness exhibited the maximum hardness in all specimens.

Summary of microstructure of 2080 steel

Heat treatments→Microstructure changes

Untreated →Carbides and pearlite in ferrite matrix

Annealed→Graphite and carbides flakes in austenite matrix

Tempered →Graphite and carbides flakes with homogenous distribution, pre-eutectic austenite, cementite and ferrite in pearlite

## References

- Bugayev, K., Tretyakov, E., & Savin, I. V. (2001). *Iron and Steel Production: Books for Business*.
- Data Sheet. (2022). Retrieved 2022, 2022, from <https://steelselector.sj.si/data/pdf/OCR12.pdf>
- Geng, B., Li, Y., Zhou, R., Wang, Q., & Jiang, Y. (2020). Formation mechanism of stacking faults and its effect on hardness in M7C3 carbides. *Materials Characterization*, 170, 110691. doi: <https://doi.org/10.1016/j.matchar.2020.110691>
- Grgac, P., Moravcik, R., Kusy, M., Toth, I., Miglierini, M., & Illekova, E. (2004). Thermal stability of metastable austenite in rapidly solidified chromium–molybdenum–vanadium tool steel powder. *Materials Science and Engineering: A*, 375, 581-584.
- Nayar, A. (2000). *The Steel Handbook*: Tata McGraw-Hill.
- Neslušán, M., Minárik, P., Čilliková, M., Kolařík, K., & Rubešová, K. (2019). Barkhausen noise emission in tool steel X210Cr12 after semi-solid processing. *Materials Characterization*, 157, 109891. doi: <https://doi.org/10.1016/j.matchar.2019.109891>
- Prabhudev, K. H. (1988). *Handbook of Heat Treatment of Steels*: Tata McGraw-Hill.
- Russell, C. S., & Vaughn, W. J. (2013). *Steel Production: Processes, Products, and Residuals*: Taylor & Francis.
- Totten, G. E., & Howes, M. A. H. (1997). *Steel Heat Treatment Handbook*: Taylor & Francis.



## ***CHAPTER 9***

### **USE OF THE ELECTROMAGNETIC SPECTRUM IN THE MEDICAL FIELD**

*Yasin DOĞANŞAH<sup>1</sup>*

*Murat KOKLU<sup>2</sup>*

---

1 Selcuk University, The Graduate School of Natural and Applied, Science, Computer Engineering, ydogansah@gmail.com, ORCID ID: 0000-0002-8153-2687

2 Selcuk University, Faculty of Technology, Computer Engineering, mkoklu@selcuk.edu.tr, ORCID ID: 0000-0002-2737-2360

## 1. ELECTROMAGNETIC SPECTRUM

### 1.1. What is Light?

Light is the phenomenon that allows radiation to be seen as a result of hitting objects or directly reflecting after it comes out of the source. Electromagnetic waves that the human eye can detect are called visible light. The wavelength range of visible light is 380 nm-760 nm.

**Light Sources:** It is divided into two as natural light sources and artificial light sources. Sources that emit light spontaneously in nature are called natural light sources. Artificial light sources, on the other hand, are the human-made light-emitting sources. The sun is the major source of natural light. Lamp, fluorescent, and fire are the examples of artificial light sources.

**Speed of Light:** The speed of light is often denoted by the letter “c”. It is a constant used in most fields of physics. The exact value of the light speed is 299,792,458 m/s. This value was finalized in 1975 and defined in the International System of Units in 1983 [Larson, 2013].

**Frequency:** Frequency, also called vibration number, is the numerical measure of how often and how many times an event is repeated in one second (unit time). It is denoted by the letter “f”.

**Period:** Being the inverse of the frequency with respect to multiplication, period expresses the time it takes for a full wave to occur. Frequency is inversely proportional to time. It is denoted by the letter “T”.

$$f = \frac{1}{T}$$

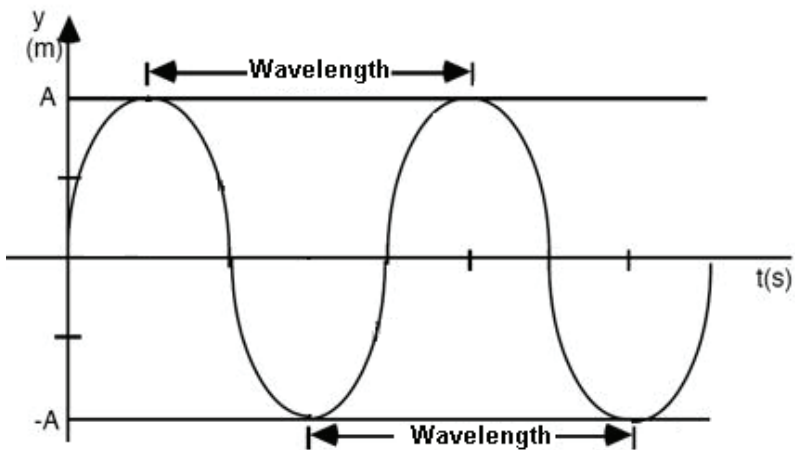
The frequency of an event is obtained by dividing the number of occurrences of the event in a given time period divided by the time

interval. In the International System of Units, the unit of frequency, hertz, is denoted by Hz.

Hertz indicates how many times an event is repeated per second. That an event has a frequency of 2 Hertz means the event repeats twice per second. Measuring the time elapsed between occurrences of the event is another way of measuring frequency. The frequency can be obtained indirectly since the measured time is based on the multiplication [Anonymous, 2021].

**Wavelength:** The time elapsed between two units of a wave pattern is called wavelength. The wavelength is usually denoted by the Greek letter lambda ( $\lambda$ ).

In Figure 1, the graph of wavelength is shown.



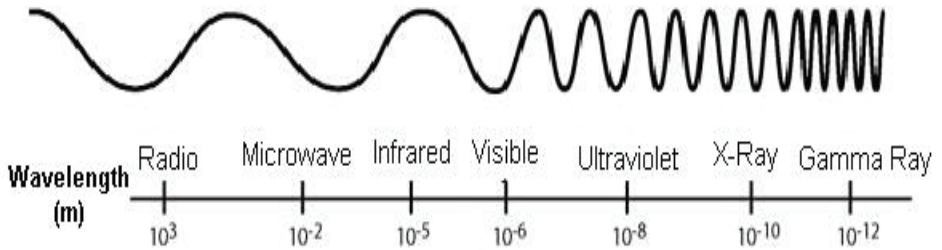
*Figure 1 Wavelength [Anonymous, 2022]*

## 1.2. Electromagnetic spectrum (EMS)

The electromagnetic spectrum (EMS) is a measure that expresses the electromagnetic radiation in any part of the universe and the relative places of different radiation derivatives in this spectrum according to their wavelengths or frequencies. The EMS of an object refers to the specific net electromagnetic radiation emitted by that object to its surroundings. The electromagnetic spectrum (EMS) includes many different radiations, starting from subatomic ( $10^{-12}$ ) values according to

their wavelengths to radio waves thousands of kilometers long [Anonymous, 2021].

Figure 2 shows different wavelengths of light and their ranges.



*Figure 2 Names of Light at Different Wavelengths [AYDIN, 2020]*

**Electromagnetic radiation;** consists of gamma rays, X-rays, ultraviolet (UV) rays, visible light, infrared rays, microwaves, and radio waves.

Figure 3 gives the spectrum ranges of light.

The electromagnetic spectrum (EMS) is ordered from long to short wavelength as follows.

Radio wave ( $10^3$  □ □

Microwave ( $10^{-2}$ ),

Infrared rays ( $10^{-5}$ ),

Visible light ( $10^{-6}$ ),

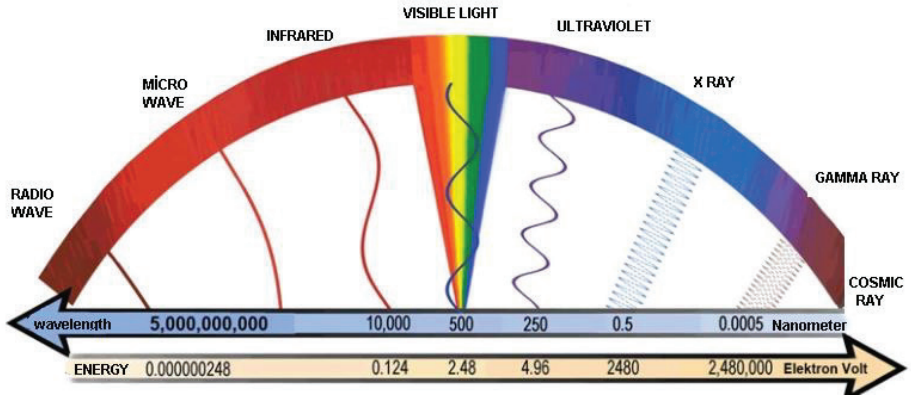
Ultraviolet ( $10^{-8}$ ),

X-rays ( $10^{-10}$ ),

Gamma rays ( $10^{-12}$ ).



The radiation energy increases as the wavelength of the electromagnetic spectrum decreases. The main source of electromagnetic radiation is the sun and it constantly affects our world.



*Figure 3 Spectrum [Anonymous, 2022]*

The wavelength exceeds 760 nm, it is called infrared, microwave, and radio wave, respectively, while it is called UV rays, X-rays, Gamma-Rays, and cosmic lights when it decreases below. Besides visible light, other rays are also used in the field of medicine, diagnosis, and treatment. While X-rays are used for diagnosis in medical imaging, infrared rays are used for therapeutic purposes in physical therapy.

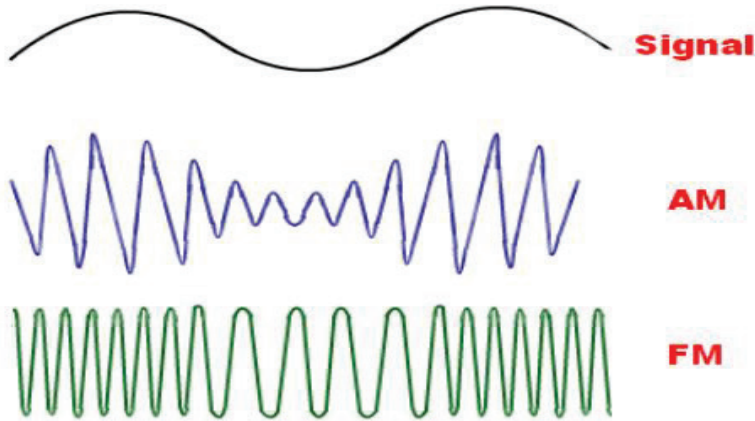
## 2. USE AREAS OF ELECTROMAGNETIC SPECTRUM

### 2.1. Radio Waves

Being used in radars, radios, and televisions, radio waves ( $10^3$ ) have the longest wavelength. The wavelength of radio waves ranges from 1 mm to 10 km.

**Frequency modulation (FM):** Denoting by the abbreviation FM, frequency modulation is a type of modulation used in communication. It was discovered by the American engineer E. Howard Armstrong in 1933.

**Amplitude modulation (AM):** Amplitude modulation, which is denoted by the abbreviation AM, is a type of modulation used in communication and broadcasting. It was developed by Canadian engineer Reginald Fessenden in 1906 [Alkadhim, 2020]. Figure 4. shows the FM and AM equivalents of any signal.

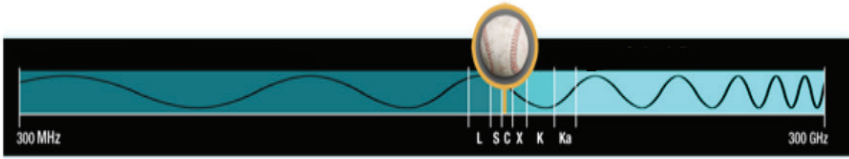


*Figure 4 FM and Signals [Açıl, 2018]*

## 2.2. Microwave

With a wavelength that varies between 1 mm and 1 meter, the microwave has the longest wavelength after radio waves. Emitting in the form of electromagnetic waves, microwaves are used in radars, microwave ovens, cell phones, and wireless internet access.

The term "microwave" describes frequencies where the wavelength is less than 1 meter. If the wavelength is shorter than 1 cm, the millimetric wave expression is used, while the wavelengths shorter than 1 mm are called submillimetric waves. Microwaves consist of L band, S band, C band, X band, and K band. In figure 5, wavelengths of microwave classes are given.



*Figure 5 Sub-spectra of microwave in practice [Haliki, 2016]*

L band is used for Global Positioning System GPS,

S band is used for microwave ovens,

C band is used for long-range communication,

and sub-spectra of X and K bands are used to send signals to satellites on the ground.

Since they are not affected by factors such as dust, smoke, clouds, rain, and snow, microwaves are widely used in satellite communication and monitoring the Earth from space [Haliki, 2016]

### **2.3. Infrared Wave**

Infrared rays are the rays that remain in the region between the visible region and the microwave in EMS. Infrared rays, whose wavelength ranges from 700 nm to 1 mm, have lower energy and longer wavelengths than radio waves and microwaves. When infrared rays are absorbed by molecules, atoms accelerate and their temperature increases. Infrared rays are widely used in daily life. In remote controls, heaters, and thermometers, infrared rays are used. Infrared rays, which are invisible to the naked eye, can be seen with cameras or specially designed tools.

In the early 19th century, W. Herschel conducted a study to measure the temperature differences between colors. It was observed that the temperature increased when the color approached red, thanks to the thermometers placed in the areas where the colors were clearly seen. This is how infrared light was discovered.

All objects emit radiation at all wavelengths due to their temperature. However, some objects emit light in the visible region. Infrared rays can create a heating effect on molecules. Such rays can be seen in infrared heaters. Similarly, objects that are not very hot emit radiation in the infrared region. These rays can be detected by cameras and thermometers [Anonymous, 2021].

Observing celestial bodies and understanding their structures, detecting heat sources such as forest fires and lava movements from satellites are some of the areas where infrared rays are used [Haliki & Kayali, 2021].

Infrared light act on the power generation center, mitochondria, for the production of ATP, which provides cellular energy. Furthermore, the respiratory enzyme Calledcytochrome C is also affected by infrared radiation [Sommer et al., 2015].

## 2.4. Ultraviolet Rays

Ultraviolet (UV) rays are electromagnetic radiation with a wavelength shorter than visible light and longer than the X-ray (approximately 10-400 nm).

UV rays are divided into two according to their wavelength ranges;

- Far Ultraviolet 10-200 nm,
- Near Ultraviolet 200-380 nm,

**Table 1** *Ultraviolet (UVA, UVB, UVC)* [Ozkutuk, 2007].

Near Ultraviolet			Far Ultraviolet
Ultraviolet (UV A)	Ultraviolet (UV B)	Ultraviolet (UV C)	10-200 nm
315-400 nm,	280-315 nm	200-280 nm	

By considering their impacts on the environment and the human health, near ultraviolet is divided into three as:

- Ultraviolet A (UV A) 315-400 nm,
- Ultraviolet B (UV B) 280-315 nm
- Ultraviolet C (UV C) 200-280 nm.

Ultraviolet rays may kill all kinds of microorganisms due to their high energy and short wavelength. 250-260 nm (253.7 nm) is the wavelength region where ultraviolet rays can kill microorganisms the most. This is also the wavelength level at which deoxyribose nucleic acid is most absorbed by DNA [Ozkutuk, 2007].

Sterilization is the destruction of all microorganisms such as viruses and bacteria on an object or in the environment. Generally, physical or chemical methods are utilized in sterilization. UV rays are used in the sterilization of materials that are not resistant to heat and moisture. It is especially preferred in medical equipment used in the health sector, in areas where invasive interventions are made, and in the water sterilization [Akyuz et al., 2018].

## **2.5. X-Rays**

X-rays are electromagnetic rays in the energy range of 0.125-125 keV or the corresponding wavelength range of 10 nm-0.01 nm.

Research on the human body is as old as humanity. Medical interventions that started with Imhotep, an Egyptian who lived in the 2600s BC and is known as the author of the first medical book, followed by Hippocrates, who lived in 460-370 BC, were introduced to the medical image in 1895, with the X-ray film by W. Rontgen, in which he imaged his wife's hand by using X-rays (Image 1) [Yuksel, 2008; Anonymous, 2021].



***Image 1** The First X-ray Film (Print of one of the first X-rays of the left hand of Anna Bertha Ludwig, wife of Wilhelm Röntgen (1845–1923). Presented to Professor Ludwig Zehender from the Institute of Physics at the University of Freiburg on 1 January.)*

A hundred years ago, invasive procedures were the only way to look inside the human body. After W. Rontgen's discovery of X-ray imaging, the need for three-dimensional imaging arose. In 1914, Mayer proposed the idea of X-ray tomography. Bocage, Grossman, and Vallebona further developed the tomography idea and designed their own equipment. Damadian and Lauterbur produced the first low-quality images with the Magnetic Resonance (MR) [Seynaeve & Broos, 1995].

## **2.6. Gamma Rays**

Gamma rays are electromagnetic spectra with a specific vibration created by the interaction of subatomic particles. They are usually formed as a result of nuclear reactions in space. Gamma rays lie between the X-rays and beta rays.

Gamma rays, first noticed by the French chemist-physicist Paul Villard while working with radium, have the lowest wavelength and highest frequency of electromagnetic rays. They damage cells due to their energy level [Anonymous, 2021].

The source of gamma rays is the atomic nucleus. The rays arise from the difference in energy levels. Gamma rays are penetrating rays and have higher energy than beta rays [T.A.E.K., 2021].

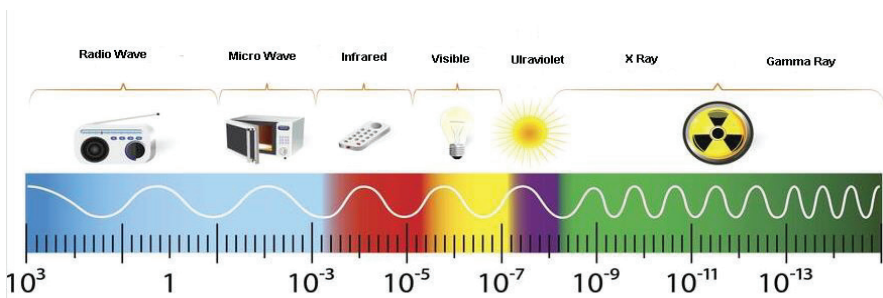
The gamma rays emitted by cobalt-60, the radioactive isotope of cobalt, are used in cancer treatment by converting into X-rays. These rays are given to the highest outer layer of the cancerous tissue in the lowest dose in order to contribute to the treatment [Anonymous, 2021].

**Cosmic Rays:** Cosmic rays are high-energy particle rain and the particles reaching the Earth's surface create secondary cosmic ray showers. In 2013, the results of the studies carried out with space telescopes showed that the major part of the cosmic rays is caused by stellar supernova explosions [Sharma, 2004].

The majority of cosmic rays occur as a result of supernova explosions. There are celestial bodies in space that emit high and low cosmic energy. In these, the sun produces low-energy cosmic rays, while the celestial body Cygnus X-3 produces very high-energy cosmic rays [Nave, 2015].

## 2.7. Visible Light

Visible light consists of electromagnetic waves that the human eye can detect. Its electromagnetic spectrum wavelength is in the range of 386 nm-760 nm. In Figure 6, visible colors and wavelengths are given.



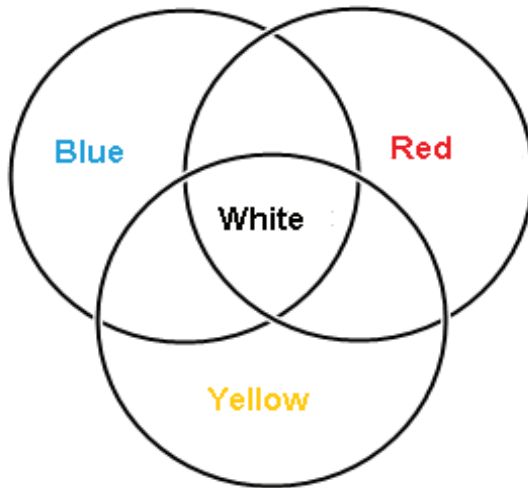
*Figure 6 Visible Light [Ocak, 2015]*

**Color:** Color is defined as the effect of light on the eye after it hits an object. It can also be defined as the form of reaction aroused in our brain by the light that hits the objects and reaches the eye. Colors are divided into two as primary colors and secondary colors.

**Primary colors:** Yellow, blue, and red are the primary colors. These colors are not a mixture of any color, but their main source. In other words, these colors cannot be obtained by mixing several colors. However, all colors except these colors are obtained by mixing primary colors in certain proportions.

**Secondary colors:** Secondary colors emerge as a result of mixing primary colors. For example, the color orange is obtained by mixing yellow and red colors in certain proportions. The desired color is obtained by mixing the main colors in certain proportions [Guler, 2015].

According to Figure 7, the combination of all colors gives the color white. Table 2 gives the wavelength ranges and the frequency ranges of visible colors.



*Figure 7 White color formation*



**Table 2** Wavelength and frequency ranges of colors

Color	Wavelength range	Frequency range
Red	~ 700–635 nm	~ 430–480 THz
Orange	~ 635–590 nm	~ 480–510 THz
Yellow	~ 590–560 nm	~ 510–540 THz
Green	~ 560–490 nm	~ 540–610 THz
Blue	~ 490–450 nm	~ 610–670 THz
Purple	~ 450–400 nm	~ 670–750 THz

Figure 8 shows the prism experiment performed by Isaac Newton in 1665. In Newton's experiment, it is seen that the prism bends visible light and each color is refracted at a slightly different angle depending on the wavelength

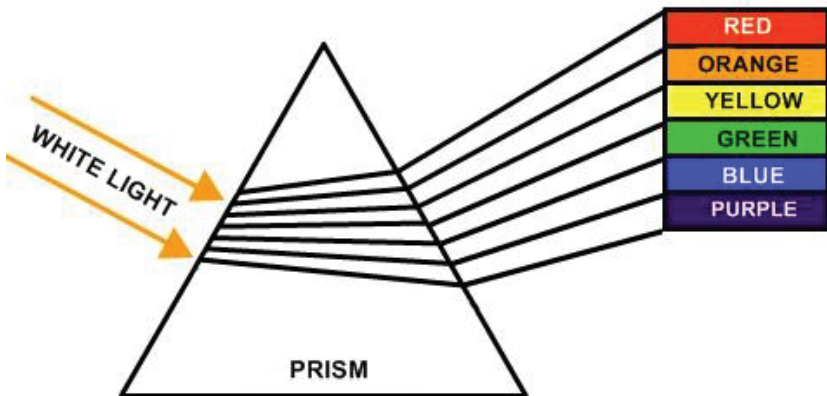
**Figure 8** White Color [Anonymous, 2022]

Table 3 gives the known secondary colors obtained from the mixture of these primary colors, except the other primary colors perceived by the eye.

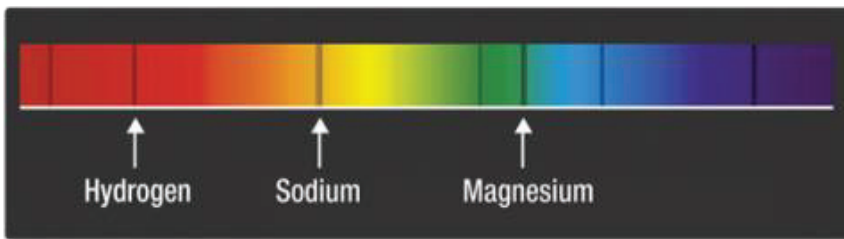
*Table 3 Mixture of Color*

Primary color	Primary color	Mixture
Yellow	Red	Orange
Yellow	Blue	Green
Red	Blue	Purple

**Color and Temperature:** As objects heat up, they emit energy within the shorter wavelengths and change color. When the fire heats up more, it changes from red to blue.

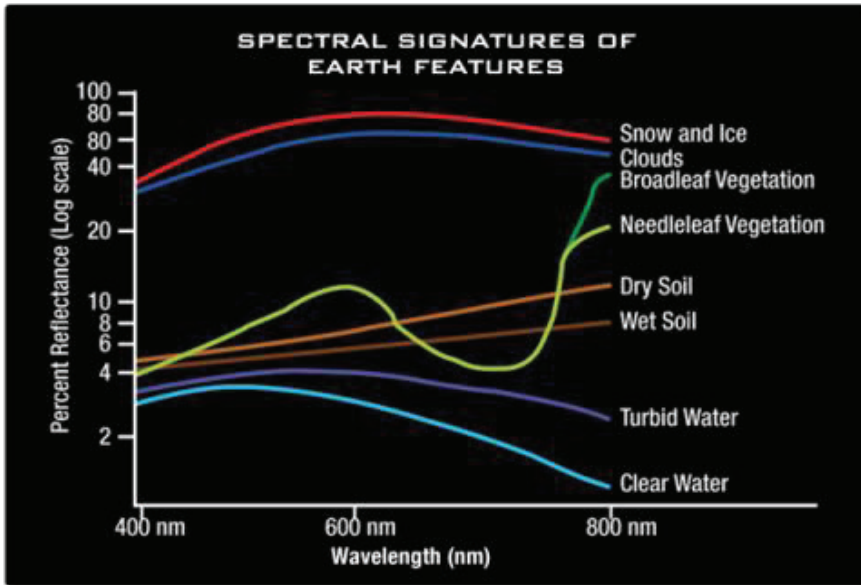
Since the surface temperature of the sun is 5,500 °C, it is seen in yellow color. If the Sun were colder, for example around 2,500 °C, it would appear reddish, or if it were warmer, e.g. 10,000 °C, it would appear blue [NASA, 2010].

**Spectra and Spectral Signatures:** As a result of the examination of the lights coming from the Sun and other celestial bodies, lines called absorption lines are encountered. While the lines form a model, these models reveal the hidden properties of objects [NASA, 2010]. Figure 9 gives the spectral signatures of some chemical elements.



*Figure 9 Traces of the Elements in Light [NASA, 2016]*

Elements in the atmosphere absorb some colors of light. These light absorptions unique to the elements function as fingerprints for atoms and molecules [NASA, 2021] (Figure 10).



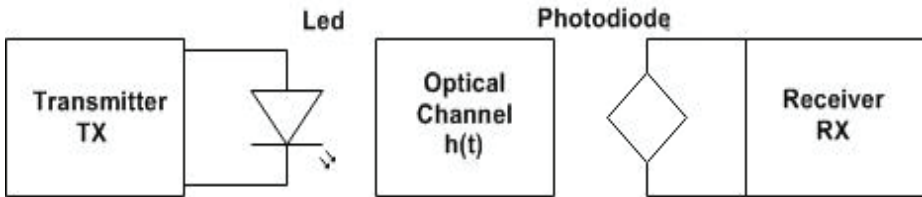
*Figure 10 Elements and spectral signature [NASA, 2016]*

**Active Remote Sensing – Altimetry Color:** The laser altimeter is a remote sensing system that uses visible light. Ice, cloud, and land height information are obtained with the laser altimeter system, which is also used by NASA. It also provides information about the height of the Earth's polar ice caps, the peak of forest vegetation, and forest structures [NASA, 2010].

**Visible Light Communication:** VLC (Visible Light Communication) employs LED lights in the visible light wavelength range of 375 nm-780 nm. It has a bandwidth of approximately 400 THz.

VLC is more advantageous in terms of service and bandwidth compared to IR and RF communication. Low power consumption and easy availability of resources also make VLC more advantageous. For this reason, it has succeeded in replacing RF technology in indoor spaces. In Figure 11, the block diagram of communication with light is given.

- Transport and Transportation,
- Hospitals and Healthcare,
- Locating in Indoor Environments,
- Defense and Security Applications,
- Aviation,
- Smart Lighting,
- Underwater Communication (Anonymous, 2021) can be given as example to the areas where VLC is used.



*Figure 11 Communication with Light [Durbayev, 2016]*

In 2011, Dr. Haas succeeded in transferring data through VLC. Thanks to this new technology called Li-Fi, it became possible to transfer data at a speed of 224 GB per second. In this study, Dr. Haas showed that too much data would be transferred in the blink of an eye [HAAS et al., 2016].

### 3. USING OF VISIBLE LIGHT IN THE MEDICAL FIELD

Light and lighting have a significant impact on human physiology and psychology in the working life [Gurel, 2001].

In dental treatment, polymerization with visible light is used as a transmission. In addition to the previously used halogen light sources, second-generation LED light sources are also used in the polymerization of the material in the dental treatment [Cekic & Ergun, 2007].

Observing that animals tend to go to areas where there is sunlight, Dr. Finsen thought that sunlight could also be beneficial to humans. With this determination, Finsen succeeded in treating Lupus Vulgaris, a skin disease, with red and blue light, and was awarded the Nobel Prize in

Medicine in 1903 with this achievement [Anders et al., 2015; Anonymus, 2021].

### **3.1. Bright Light and Day Light**

Bright light therapy is a treatment method that helps people to regulate moods, improves sleep quality, and increases the effect of drugs used for depression treatment. This treatment method has also been studied for the treatment of Alzheimer's, rhythm and eating disorders, attention deficit, hyperactivity, and behavior disorder, and it has been seen that the side effects of the treatment are temporary [Ozdemir et al., 2017].

According to Tracy Bedrosian, life on Earth has adapted to the 24-hour solar cycle. Since the invention of artificial light, people have been exposed to artificial light for longer periods as a result of working the night shift. The brain, which is exposed to artificial light at night, receives messages that it should not receive and his situation results in mood disorders such as depression.

The visual effect of the lights used in the workplaces on the product presentation is known. The employee has continued to work under the spotlights without seeing the daylight since the beginning of the working hour. In addition to the fact that the employees do not experience the "day" concept because of this situation, working under the same spectrum level of light all the time causes psychological disturbances and low productivity.

### **3.2. Violet Light within the wavelength of 10-400 nm**

#### **Sterilization with Ultraviolet**

Sterilization with UV rays is the destruction of all microorganisms such as viruses and bacteria in environments and materials that are not resistant to heat and humidity with ultraviolet light. This method is especially used for sterilizing medical materials used in the health sector, areas where invasive interventions are made, and water [Akyuz et al., 2018].

Operating rooms and surgical equipment in healthcare centers where surgical procedures are performed are sterilized in this way and prepared for reuse. As well as the healthcare field, devices used in food technology, coolers, and personal care centers are also sterilized with ultraviolet rays due to their short sterilization period.

### **Synthesis of Vitamin D by Ultraviolet**

Vitamin D deficiency causes growth retardation and rickets in children, while it increases the risk of osteoporosis, susceptibility to bone fractures, cardiovascular diseases, autoimmune diseases, and infectious diseases in adults. Sunlight is the best source of vitamin D intake. With exposure to sunlight, ultraviolet B photons in the sun enter the skin and synthesize vitamin D [Holick, 2008].

### **3.3. Blue Light within the wavelength of 450-470 nm**

It is used in antibiotic therapy or in the treatment of bacterial infections with resistance in the body. In addition to these treatments, the efficacy of the treatment has been increased by using blue laser light, especially for the prevention of *Pseudomonas aeruginosa* infections [Rupel, 2019].

### **3.4. Blue Light Phototherapy**

#### **3.4.1. Neonatal Jaundice**

The probability of neonatal jaundice in our country and in the world is 60% in born mature (40 weeks and later) and 80% in preterm delivery (40 weeks and before) [Kilic, 2021].

Neonatal jaundice, a type of jaundice that results from increased bilirubin levels in newborn infants, appears within 48 to 96 hours following birth and usually heals spontaneously within 1-2 weeks. In neonatal jaundice, unconjugated bilirubin, which occurs with the destruction of red blood cells, cannot be eliminated and accumulates in the skin, resulting in the waste product [Woodgate & Jardine, 2015; Tan et al., 2012].

In order to remove this unconjugated bilirubin accumulated in the skin, blue light is given to the newborn in the wavelength range of 425 nm-460 nm. This process is called phototherapy in the literature. Lights in other wavelength ranges are also known to reduce bilirubin levels. However, the most effective wavelength is between 425 nm and 460 nm. With this treatment, the unconjugated bilirubin accumulated in the liver is converted into water-soluble isomers and excreted from the body, so the bilirubin level is lowered [Stokowski, 2006].

Depending on the level of bilirubin in the infants' blood, there may be yellowing in body parts. If this level is between

5 and 8 mg/dl, the yellowing occurs in the head and neck region,

8 and 10 mg/dl, the yellowing occurs in the upper part of the body,

10 and 13 mg/dl, the yellowing occurs in the lower part of the body,

13 and 16 mg/dl the yellowing occurs in the arms and legs,

and if it is around 20 mg/dl, the yellowing occurs on the hands and feet. [Kilic, 2021].

Whether to start phototherapy or the duration of treatment is determined by the physician by looking at the bilirubin level in the blood. In cases where the bilirubin level in the blood rises to 15mg/dl and above, the newborn infant should receive phototherapy.

The treatment of jaundice with visible light can also be carried out with white or green light. However, it was observed that bilirubin was absorbed by interacting better with blue light in the wavelength range of 450-460 nm. Since blue light provided more effective results, blue light treatment is generally preferred in jaundice cases [Cetinkaya et al., 2006]

### **3.4.2. Crigner Najjar Syndrome**

Crigner Najjar Syndrome (CNS) Type I and Type II are genetic diseases. The glucuronic enzyme in the body is responsible for removing bilirubin. Because the bilirubin cannot be dissolved in water directly. Glucuronic acid is required for bilirubin to dissolve in water. In case of

insufficiency of this enzyme, Crigler Najjar Type I develops, while its deficiency leads to Crigler Najjar Type II disease [Kumar et al., 2017].

Crigler Najjar Type I syndrome is a recessive inherited disorder. For the treatment of Crigler Najjar syndrome, which is caused by the substance bilirubin in the blood, phototherapy should be implied to the whole body of patients for 14-16 hours daily. Although phototherapy treatment reduces the bilirubin level of patients, this level increase again after the treatment. For this reason, patients with CNS should receive continuous phototherapy. On the other hand, it is considered that the only definitive treatment for CNS is liver transplantation [Fox et al., 1998; Guven et al., 2002].

### **3.5. Green Light with 532 nm Wavelength**

About a century ago, Ciamician et al. realized that green light, which is a large and continuously renewable source of energy, is effective in chemical reactions [Narayanam & Stephenson, 2011].

#### **Greenlight**

Greenlight with a wavelength of 532 nm is used in the treatment of the prostate. While this treatment called GreenLight XPS had been carried out with the photo-selective evaporation method using 60-80 W energy in the early 2000s, this interval increased up to 120 W-180 W with the recent technological developments today [Ruszat, 2008].

### **3.6. Red Light within the Wavelength Range of 635-700 nm**

Mentioning that working at night causes mental disorders, Dr. Nelson put forward that the negative effects of mood disorders caused by night working environments can be avoided thanks to red lights. The results of the research published in The Journal of Neuroscience in August 2013 revealed that the light in the environment perceived by the eye contributes to the proper functioning of the body's biological clock, called the circadian clock [Navara & Nelson, 2007; Gurdilek, 2021].

According to Dr. Randy Nelson, Neurology and Psychology Professor; the ipRGC cell in the eye, which is sensitive to electromagnetic spectra, is most sensitive to blue light, while it is less



sensitive to red light, with less scattered and has long wavelengths [Navara & Nelson, 2007; Bedrosian & Nelson, 2013; Gurdilek, 2021].

Red light changes the physical features of water, which in turn turbocharges the chemical reactions that provide the cell's energy. About 40 years ago, the result of the LED research by German researcher Andrei Sommer, revealed the effect of light with a wavelength of 670 nm. Sleep deprivation, waking up tired, and sleep apnea are the main sleep problems. The underlying cause of these problems is the decrease in the amount of oxygen in the blood and, accordingly, the decrease in sleep quality. Sleeping in red light may enhance the sleep quality sleep by increasing the oxygen level in the blood and contributing to blood circulation.

Raymond et al., applied low-level red laser therapy (LLLT) to the balding area in men aged 18-60 years with hair loss and achieved a significant increase in hair strands in the related area [Lanzafame, 2014].

It was determined that red and near infrared light have a number of physiological impacts on animal and human tissues, such as reducing inflammation, healing wounds, and reducing pain. This therapy, known as photo-biomodulation (PBM), has been used as low-level laser therapy since the late 1960s [Heiskanen & Hamblin, 2018].

Red light with a wavelength of 632.8 nm contributes to the healing of skin wounds by providing the repair of tissues [Ribeiro, 2004].

## REFERENCES

- Carniol, P. and N.S. Sadick, *Clinical procedures in laser skin rejuvenation*. 2007: CRC Press.
- Roelandts, R., *A new light on Niels Finsen, a century after his Nobel Prize*. 2005, Wiley Online Library.
- Honigsmann, H., *History of phototherapy in dermatology*. Photochemical & photobiological sciences, 2013. **12**(1): p. 16-21.
- Yurdakok M., *Light and drug therapy in hyperbilirubinemia*. Contribution Pediatri Magazine, (In Turkish) **1995** (5): p. 725-733.
- Perincek, S.D., K. Duran, A.E. KORLU, and M.I. Bahtiyari, *Ultraviolet technology*. Textile and apparel, (In Turkish) 2007. **17**(4): p. 219-223.
- Tan, I., O. Salihoglu, Y. Demirelli, and S. Hatipoglu, *Clinical and laboratory characteristics and associated risk factors of infants admitted to the neonatal unit due to indirect hyperbilirubinemia* (In Turkish) . J Clin Exp Invest [www.jceionline.org](http://www.jceionline.org) Vol, 2012. **3**(1).
- Cetinkaya, M., N. KOKSAL, and H. OZKAN, *Treatment approach in neonatal jaundice*. Current Pediatrics, (In Turkish) 2006. **4**(1): p. 118-123.
- Kilic, I. *What is newborn jaundice?* (In Turkish) 2020 04.04.2021]; Available from: <https://www.florence.com.tr/yenidogan-sariligi>.
- Unalan, F., *Microwave and Ultraviolet's effectiveness in sterilization*. Sterilization Disinfection Hospital Infections, (In Turkish) 2002.
- Akyuz, A.O., I. Onur, K. Kumas, D. Temiz, and F. Yoldas, *UV Sterilization Unit Design for Biomedical Departments of Vocational Schools and Engineering Faculties*. Journal of Technical Sciences, (In Turkish) 2018. **8**(2): p. 1-4.
- Haliki E., O.K. *Electromagnetic Waves: What is Infrared?* (In Turkish) 2021 16.04.2021]; Available from: <https://rasyonalist.org/yazi/kizilotesi-infrared/>.
- Ozkutuk, N., *Use of ultraviolet lamps*. National Sterilization Disinfection Congress. (In Turkish) April, 2007: p. 4-8.
- Yüksel, A., *Division of bone tissue in X-ray hand images*. 2008, Institute of Science. (In Turkish)
- Seynaeve, P. and J. Broos, *The history of tomography*. Journal belge de radiologie, 1995. **78**(5): p. 284-288.

- NASA, S.M.D. *Visible Light*. 2010 [20.04.2021]; Available from: [http://science.nasa.gov/ems/09\\_visiblelight](http://science.nasa.gov/ems/09_visiblelight).
- Haas, H., L. Yin, Y. Wang, and C. Chen, *What is LiFi?* Journal of Lightwave Technology, 2016. **34**(6): p. 1533-1544, doi:10.1109/JLT.2015.2510021.
- Ozdemir, P. G., YILMAZ E., SELVI, Y., BOYSAN M., Current Approaches in Psychiatry 2017;9(2):177-188 doi:10.18863/pgy.281382
- Larson, R., *Elementary and Intermediate Algebra: Algebra Within Reach*. 2013: Cengage Learning.
- Ruszat, R., et al., *GreenLight laser vaporization of the prostate: single-center experience and long-term results after 500 procedures*. european urology, 2008. **54**(4): p. 893-901.
- Navara, K.J. and R.J. Nelson, *The dark side of light at night: physiological, epidemiological, and ecological consequences*. Journal of pineal research, 2007. **43**(3): p. 215-224.
- University, O.S. *What color is your night light? It may affect your mood*. ScienceDaily 2013 [27.04.2021]; Available from: [www.sciencedaily.com/releases/2013/08/130806203150.htm](http://www.sciencedaily.com/releases/2013/08/130806203150.htm).
- Bedrosian, T.A. and R.J. Nelson, *Influence of the modern light environment on mood*. Molecular psychiatry, 2013. **18**(7): p. 751-757.
- Sommer, A.P., M.K. Haddad, and H.-J. Fecht, *Light effect on water viscosity: implication for ATP biosynthesis*. Scientific reports, 2015. **5**(1): p. 1-6.
- Gurel, E., *The importance of light and lighting in working life*. (In Turkish) MUGLA University Journal of Institute of Social Sciences, 2001(5).
- Narayanam, J.M. and C.R. Stephenson, *Visible light photoredox catalysis: applications in organic synthesis*. Chemical Society Reviews, 2011. **40**(1): p. 102-113.
- Cekic, I. and G. Ergun, *Visible light sources used in dentistry*. Gazi University Faculty of Dentistry Journal, (In Turkish) 2007. **24**(2): p. 131-136.
- Lanzafame, R.J., R.R. Blanche, R.P. Chiacchierini, E.R. Kazmirek, and J.A. Sklar, *The growth of human scalp hair in females using visible red light laser and LED sources*. Lasers in surgery and medicine, 2014. **46**(8): p. 601-607.

- Kolar, J., M. Strlic, S. Pentzien, and W. Kautek, *Near-UV, visible and IR pulsed laser light interaction with cellulose*. Applied Physics A, 2000. **71**(1): p. 87-90.
- Heiskanen, V. and M.R. Hamblin, *Photobiomodulation: lasers vs. light emitting diodes?* Photochemical & Photobiological Sciences, 2018. **17**(8): p. 1003-1017.
- Ribeiro, M.S., et al., *Effects of low-intensity polarized visible laser radiation on skin burns: a light microscopy study*. Journal of clinical laser medicine & surgery, 2004. **22**(1): p. 59-66.
- Anders, J.J., R.J. Lanza fame, and P.R. Arany, *Low-level light/laser therapy versus photobiomodulation therapy*. 2015, Mary Ann Liebert, Inc. 140 Huguenot Street, 3rd Floor New Rochelle, NY 10801 USA.
- Anonymous. *Niels Ryberg Finsen Biographical*. 2021 [12.04.2021]; Available from:  
<https://www.nobelprize.org/prizes/medicine/1903/finsen/biographical/>.
- Amat, A., J. Rigau, R.W. Waynant, I.K. Ilev, J. Tomas, and J.J. Anders, *Modification of the intrinsic fluorescence and the biochemical behavior of ATP after irradiation with visible and near-infrared laser light*. Journal of Photochemistry and Photobiology B: Biology, 2005. **81**(1): p. 26-32.
- Rupel, K., et al., *Blue laser light inhibits biofilm formation in vitro and in vivo by inducing oxidative stress*. NPJ biofilms and microbiomes, 2019. **5**(1): p. 1-11.
- Anonymous. *Frequency*. 25.04.2021]; Available from:  
<https://tr.wikipedia.org/wiki/Frekans>.
- Anonymous. *Electromagnetic spectrum*. 25.04.2021]; Available from:  
[https://tr.wikipedia.org/wiki/Elektromanyetik\\_spektrum](https://tr.wikipedia.org/wiki/Elektromanyetik_spektrum).
- Alkadhim, S.A.S., *Generation Of Amplitude Modulated Signals*. 2020.
- Anonymous. *Electromagnetic Spectrum*. 22.04.2021]; Available from:  
<https://physics.info/em-spectrum/>.
- Anonymous. *Medical imaging*. 22.04.2021]; Available from:  
[https://en.wikipedia.org/wiki/Medical\\_imaging](https://en.wikipedia.org/wiki/Medical_imaging).
- Sneitz, N., Bakker, C. T., de Knecht, R. J., Halley, D. J., Finel, M., & Bosma, P. J. (2010). Crigler-Najjar syndrome in The Netherlands: identification of four

- novel UGT1A1 alleles, genotype-phenotype correlation, and functional analysis of 10 missense mutants. *Human mutation*, 31(1), 52–59. <https://doi.org/10.1002/humu.21133>
- Anonymous. *Gamma Rays*. (In Turkish) 21.03.2021]; Available from: [https://tr.wikipedia.org/wiki/Gama\\_%C4%B1%C5%9F%C4%B1n%C4%B1](https://tr.wikipedia.org/wiki/Gama_%C4%B1%C5%9F%C4%B1n%C4%B1) 1.
- Institution, T.A.E. *Gamma Rays*. (In Turkish) 01.02.2021]; Available from: [http://www.taek.gov.tr/bilgi/elkitabi\\_brosur/radyasyonvebiz/r07.htm](http://www.taek.gov.tr/bilgi/elkitabi_brosur/radyasyonvebiz/r07.htm).
- Sharma, S.K., *Atomic and nuclear physics*. 2004: Pearson Education India.
- Nave, C.R., *Cosmic rays*. Hyper Physics Concepts, Georgia State University, Retrieved, 2015. 17.
- Guler, A., *Color names in Turkish language*. (In Turkish) Hëna e Plote “Bedër” Universty 2015
- Allen, J. 22.02.2021]; Available from: [http://missionscience.nasa.gov/ems/09\\_visiblelight.html](http://missionscience.nasa.gov/ems/09_visiblelight.html).
- Gurdilek, R. *Red Night Lamp Healthy*. (In Turkish) 2016 11.04.2021]; Available from: <https://kurious.ku.edu.tr/haberler/kirmizi-gece-lambasi-saglikli/>.
- Haliki E Electromagnetic Waves: Microwave (In Turkish) 2016 Available From: <https://rasyonalist.org/yazi/elektromanyetik-dalgalar-mikrodalga/>
- Anonymous. *Wavelength* 24.05.2022]; Available from: <https://diyot.net/dalga-boyu/>
- Ocak, M.E. What is the Light Spectrum? (In Turkish) 12/01/2015 Available from: <https://bilimgenc.tubitak.gov.tr/makale/isik-tayfi-nedir?> Erişim Tarihi:10.03.2022
- Anonymous. Color Spectrum. (In Turkish) 01.03.2022]; Available from: <http://bilgioloji.com/pages/fen/fizik/optik/isik-renk-tayfi-nedir/>
- Holick M. F. (2008). Sunlight, UV-radiation, vitamin D and skin cancer: how much sunlight do we need?. *Advances in experimental medicine and biology*, 624, 1–15. [https://doi.org/10.1007/978-0-387-77574-6\\_1](https://doi.org/10.1007/978-0-387-77574-6_1)
- NASA, Science Mission Directorate. (2010). Visible Light. Retrieved [insert date - e.g. August 10, 2016], from NASA Science website: [http://science.nasa.gov/ems/09\\_visiblelight](http://science.nasa.gov/ems/09_visiblelight).

Udomuksorn, W., Elliot, D. J., Lewis, B. C., Mackenzie, P. I., Yoovathaworn, K., & Miners, J. O. (2007). Influence of mutations associated with Gilbert and Crigler-Najjar type II syndromes on the glucuronidation kinetics of bilirubin and other UDP-glucuronosyltransferase 1A substrates. *Pharmacogenetics and genomics*, *17*(12), 1017–1029. <https://doi.org/10.1097/FPC.0b013e328256b1b6>



**CHAPTER 10**

**NEW CONCEPTS OF ADDITIVE  
MANUFACTURING TECHNIQUES: 5D AND  
6D PRINTING**

*Meltem ERYILDIZ<sup>1</sup>*

---

<sup>1</sup> <sup>\*</sup>Department of Mechanical Engineering, Beykent University, Istanbul, Turkey ,  
meltemeryildiz@beykent.edu.tr , <https://orcid.org/0000-0002-2683-560X>

## 1. INTRODUCTION

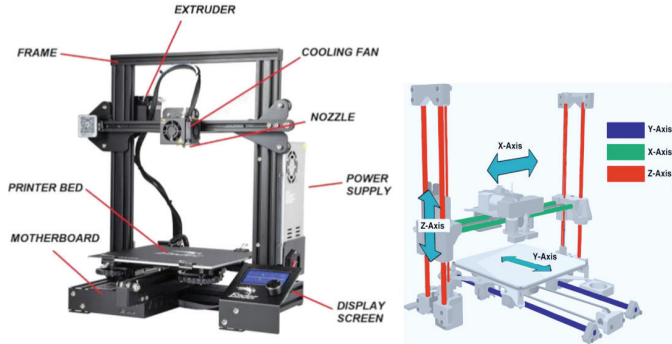
For quite some time, three-dimensional (3D) printing has been a well-established additive manufacturing technique in the industry. While new applications, materials, and 3D printers are continually being developed in the additive manufacturing industry, new technologies are being researched. A new type of additive manufacturing is five-dimensional (5D) printing and six-dimensional (6D) printing which are currently being considered and tested. 5D printing provides the capacity to print in a five-axis, allowing the layers to be printed in any desired layers and curves. 6D printing is the capacity to modify the form of 5D printed things over time. The final part will be built using five degrees of freedom in the printing process, and the final fabricated part will be smart/intelligent. Due to its interaction with environmental stimuli, the final fabricated part will be able to change its shape or properties. The basics, current applications, and future potential of the most recent additive manufacturing technologies (5D and 6D printing) are reviewed and summarized in this study.

Additive manufacturing (AM), often known as three-dimensional (3D) printing, has attracted the interest of the academic and industrial sector in recent years, and it is becoming increasingly important as part of Industry 4.0. This technology is described as follows: “A process of joining materials to create objects from 3D model data, usually layer upon layer” (Auffray et al., 2022). Varied AM techniques such as material extrusion, directed energy deposition, binder jetting, vat photo polymerization, powder bed fusion, material jetting, sheet lamination have been developed over the years (Mandala et al., 2022). Material extrusion based fused deposition modeling (FDM) is one of the most affirmative AM techniques of all the known approaches. Researchers, industrialists, and academia have embraced FDM as the most prevalent method due to its simple manufacturing process, durability, dimensional stability, minimal maintenance, and price in the creation of high-precise components (Mandala et al., 2022; Zharylkassyn et al., 2021). In FDM, a spool of filament is pulled through the extruder. The filament is heated to a semi-molten state by the extruder head. As seen in Figure 1, semi-molten filament is extruded through a nozzle and deposited in thin layers parallel to the XY plane on the platform. Following the layer assembling, either the platform or the nozzle head is moved along the Z-axis, precisely following one layer thickness. Because the material is semi-molten, surrounding layers can fuse together to produce the 3D solid component layer by layer (Mandala et al., 2022; Kumaresan et al., 2021).

Some 3D objects may have overhangs, requiring the usage of a support structure during the printing process. On the FDM printer, the support structure can be printed in a more fragile form that can be snipped off after printing is complete. Besides, some printers use a second nozzle



that uses a different material to print the support structure simultaneously with the main object. The support structure material can be soluble and can be removed from the object after the printing is finished (Gobbato, 2019; Gordelier et al., 2019).



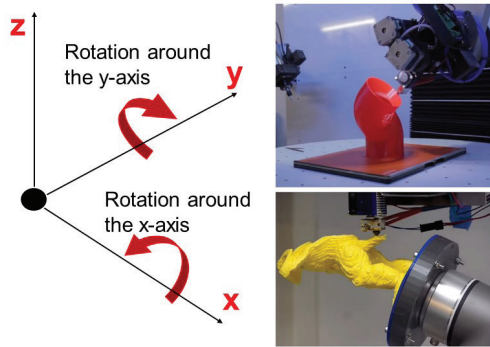
**Figure 1.** Three-dimensional printing technology and axis movements (Gobbato, 2019)

Five-dimensional (5D) and six-dimensional (6D) printing technology are new types of additive manufacturing. They are only the most recent roots to emerge from additive manufacturing, but there will undoubtedly be more in the future. The goal of this research is to review the 5D printing and 6D printing processes and to evaluate their current and potential application areas.

## 2. 5D PRINTING TECHNOLOGY AND ITS POTENTIAL APPLICATIONS

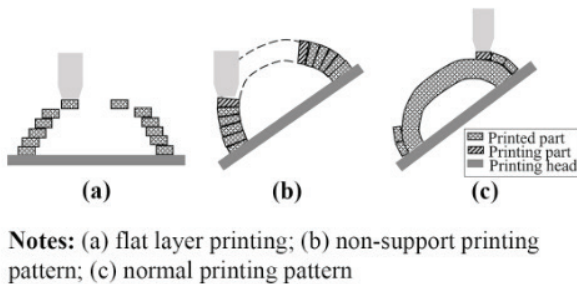
In 2016, American institutions introduced the notion of 5D printing. Mitsubishi Electric Research Labs (MERL) is now implementing it through William Yerazunis, a senior principal research scientist (Haleem et al., 2019).

The extruder head and the printed item both have five degrees of freedom with this technology. The 5D printing method can create curved layers instead of flat layers. This method employs a five-axis printing process to create objects in multiple dimensions, rather than the three axes used in 3D printing. Aside from the X, Y, and Z-axes of 3D printing, the print bed or nozzle head may move back and forth on two axes in this five-axis printing. Thus, rather than advancing through a straight layer as 3D printers do printing follows the printed part's curve path. As a result, when compared to 3D-printed parts, this technique is capable of manufacturing a part with a curved layer that is far stronger (Anas et al., 2021; Haleem and Javaid, 2019a; Haleem and Javaid, 2019b).



**Figure 2.** *Five-dimensional printing technology axis movements*

The mesostructure, which is determined by printing conditions and the distribution of layers, has a significant impact on the mechanical properties of printed parts. To improve mechanical properties, flat-layered deposition was used with an orthogonal infill pattern and a lower layer thickness. However, because of extreme anisotropy caused by the reduced adhesive strength between layers, these approaches are ineffective for shell-like elements. In this case, curved layer deposition as seen in Figure 3 can be applied and anisotropy can be decreased (Feng et al., 2021).



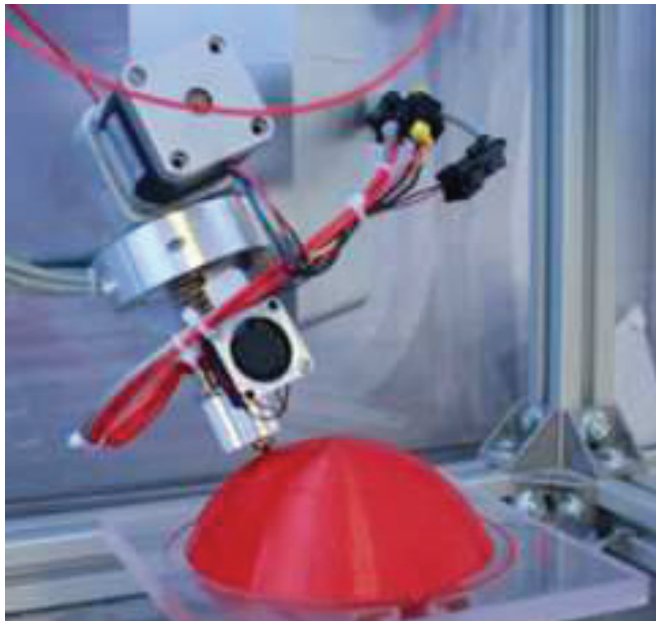
**Figure 3.** *a) flat layer printing, b) non-support printing (Feng et al., 2021).*

To manufacture artificial bone for surgery, a 5D printed model can be employed. Since bones have curved surfaces instead of flat surfaces, artificial bones must be manufactured using five-dimensional printing to ensure that these bone implants are extremely strong. 3D printing is not very suitable for making complex curved orthopedic implants because it employs flat layers. Table 1 summarizes recent breakthroughs in 5D printing applications (Haleem et al., 2019; Anas et al., 2021; Haleem and Javaid, 2019a; Haleem and Javaid, 2019a; Haleem and Javaid, 2019b).

**Table 1.** *Expected applications of 5D printing*

Surgical instruments	Surgical instruments such as monopolar diathermy, DeBaKey forceps, mosquito forceps, and so on.
Prosthetics	Artificial body parts with complicated geometries (the lower jaw, hand, and teeth) require a lot of strength.
Bone traction	Buttress plates, medical pipes, medical fasteners, etc.
Construction and Automobile	Building houses with complicated and curved shapes, producing a precise prototype of a section of a vehicle compound.
Food	Food structures that are complex and curved can be made with less material and with increased strength to keep their characteristic shape throughout transportation.

Additive manufacturing can create parts with complicated geometry that are impossible to achieve with subtractive manufacturing. In this technique, layer-by-layer deposition is often used. Recent research examines the advantages of curved layers (rather than flat ones) for locating print paths and compares them to planar slicing which is still a popular method for building parts. However, it can cause stair-stepping in the printed object and poor mechanical properties (Gunpinar and Cam, 2022). A concave cap, for example, is an object with a complicated design because it requires a lot of support, it cannot be 3D printed. 5D printing facilitates printing by allowing for the generation of curved layers. An example of a 5D printed concave cap is shown in Figure 4, and it is easy to see how it is not feasible to produce using 3D printing (Reddy and Devi, 2018).

**Figure 4.** *Five-dimensional printing of a concave cap (Reddy and Devi, 2018)*

Merl's Laboratory conducted a case study comparing two technologies, according to the results, objects printed in 5D were 3-5 times more durable than those printed in 3D. It has also been determined that a 5D printed cap is four times stronger than a 3D printed cap and can withstand four times more pressure. This technology has a lot of potential to meet this major need (Haleem et al., 2019; Anas et al., 2021; Haleem and Javaid, 2019a; Haleem and Javaid, 2019a; Haleem and Javaid, 2019b; Reddy and Devi, 2018).

Other significant benefit of this new method is that it needs 25% less material than traditional 3D printing. There is a material force that emerges during the printing of curved layers, which makes the printed parts stronger. As a result, compared to 3D printing, less raw material is used to make implants of the same strength (Haleem et al., 2019; Anas et al., 2021; Haleem and Javaid, 2019a; Haleem and Javaid, 2019a; Haleem and Javaid, 2019b).

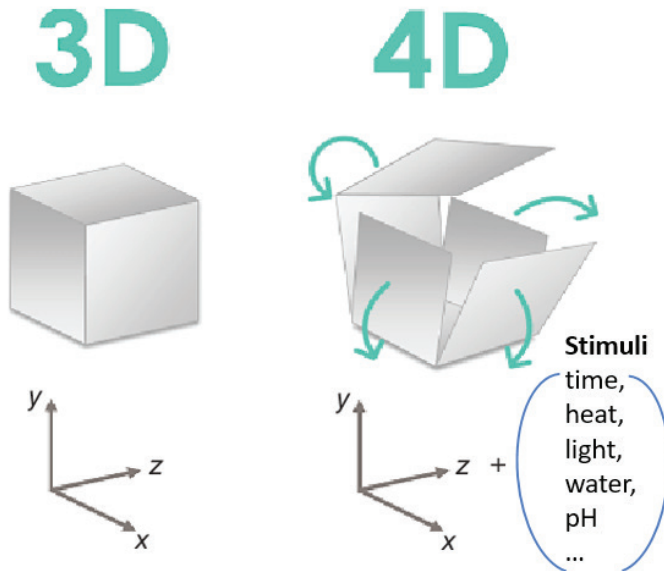
In the food field, food components can be manufactured with any form of infill and density using 5D printing while keeping the product's form, which is useful for fabricating food products with a variety of textures to appeal to a wide range of consumer tastes. Furthermore, 5D printing's ability to rotate the print bed and extruder head allows for the creation of food products with smooth and curved edges, making them more appealing to customers. Additionally, equipment for transportation and handling of agricultural products frequently requires the development of complicated forms that fit the product's shape. Thus, in these cases, 5D printing could be a viable option (Ghazal et al., 2022).

With 5D printing, buildings with curved and complex designs and an exact prototype of a vehicle compound section can be fabricated (Haleem and Javaid, 2019b; Reddy and Devi, 2018; Ghazal et al., 2022).

The expense of the two extra axes of print bed motion is the fundamental problem and constraint of 5D printing technology. 5D printing technology, like 3D printing, has the potential to generate incredible advancements and advances in a multitude of areas in the near future, including engineering, dentistry, orthopedics, medical, food, and more.

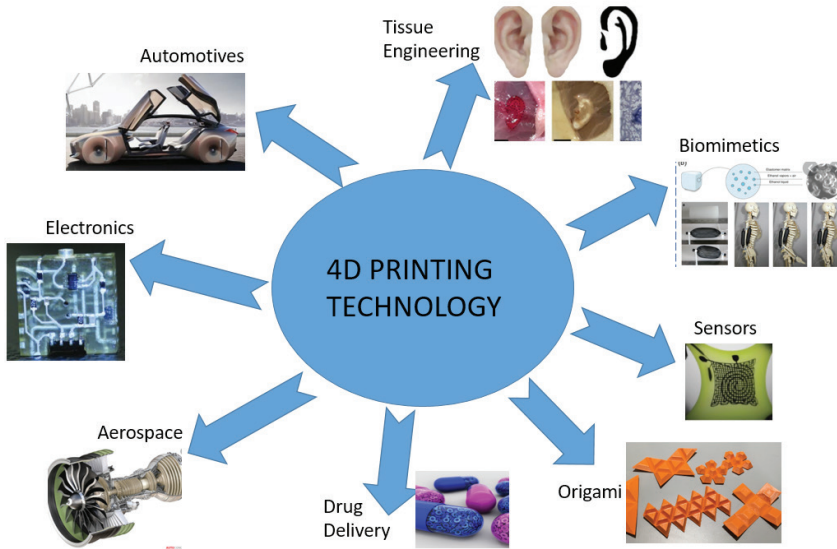
### **3. 6D PRINTING TECHNOLOGY AND ITS EXPECTED APPLICATIONS**

When objects are removed from a 3D printer, they change shape, which is known as 4D printing. Due to the chemical interaction of the materials utilized, these items self-assemble when exposed to water, heat, and air, among other things. As shown in Figure 5, 4D printing is a mix of a 3D printer, intelligent material, and a well-programmed design (Ahmed et al., 2021).



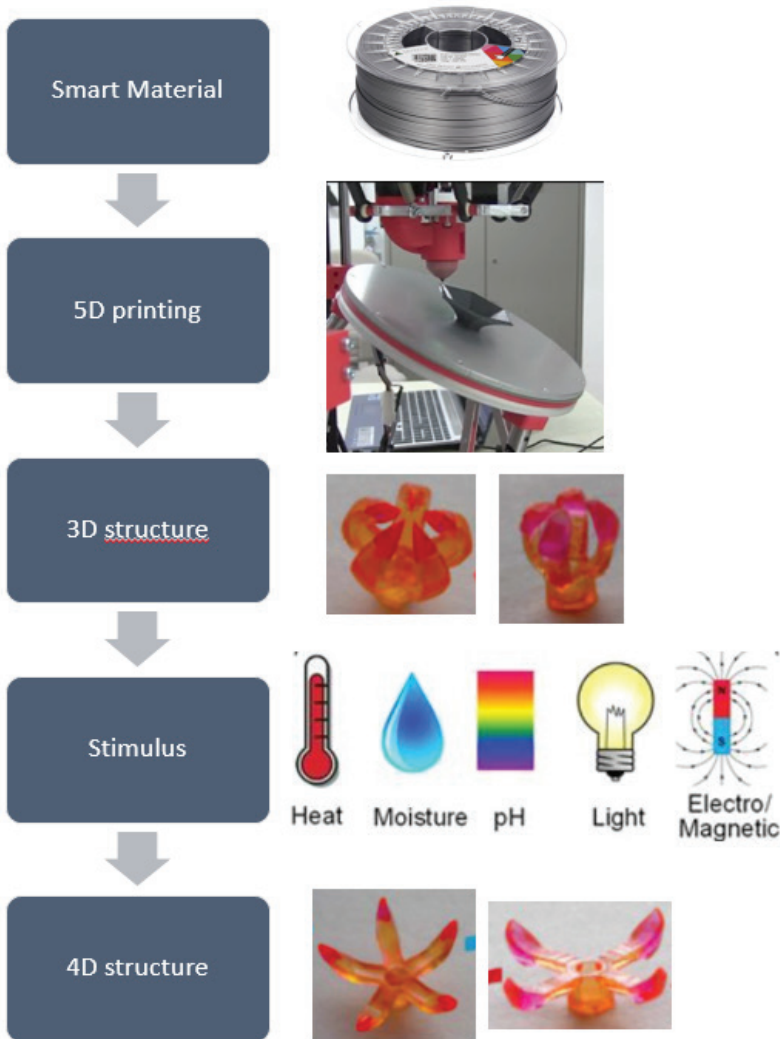
**Figure 5.** *From 3D printing to 4D printing*

Many investigations on shape-memory materials, sometimes known as “smart” materials, have been conducted over the last two decades. Under the right conditions, these materials have the ability to alter their shape or properties. The most popular of these materials are metal alloys and polymers, which have received a lot of attention. The development of 3D-printable “smart” materials has propelled three-dimensional (3D) printing to a new level known as four-dimensional (4D) printing. 3D printing is combined with the fourth dimension, usually time, to create 4D printing. This method enables a printed object to alter its shape while adjusting to its environment. The rapid growth of smart materials and the most recent advancements in multi-material printing have fueled this revolutionary technology, and there are many more prospects and uses to be discovered (Lee et al., 2017). While 4D printing appears to be promising for a range of applications, including construction, automotive, medicine, packaging (see Figure 6), it is still a new and undeveloped technology that faces significant challenges (Lee et al., 2017).



**Figure 6.** *4D printing technology and its applications*

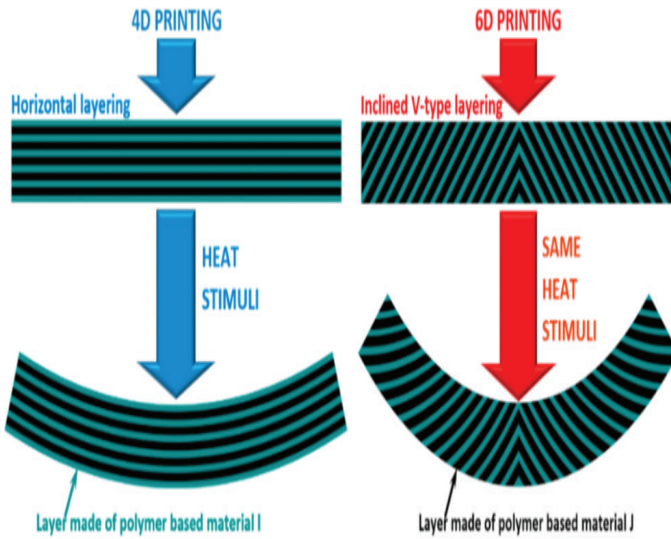
Six-dimensional (6D) printing is a fascinating latest invention for additive manufacturing method that combines four-dimensional (4D) and five-dimensional (5D) printing. Under stimulating circumstances, the 6D printed part may be seen as the child of a five-axis printer combining FDM technology and smart materials (Figure 7) (Georgantzinos et al., 2021). It combines the ability of 5D printing to generate the most complicated shapes with increased strength and lower resource usage, and it combines the ability of 4D printing to change form, color, or other characteristics over time in response to stimuli. This combination generates components that are more durable and functional than those manufactured in 4D and 5D printing. Furthermore, because of the processing flexibility it provides, 6D printing technology combined with the right configuration may reduce material usage and processing times at the same time (Ghazal et al., 2022).



**Figure 7.** Six-dimensional printing process (Georgantzinou et al., 2021).

As illustrated in Figure 8, Georgantzinou et al. (2021) provided and offered an example and a graphical comparison to show how 6D printing is superior to 4D printing. By merging layers of diverse polymer media, the up and bottom smart material parts are created utilizing 4D and 6D printing processes, respectively. Because they are made up of alternating layers of two different polymeric materials, the 4D and 6D printed smart materials will eventually flex when subjected to heat or temperature (Georgantzinou et al., 2021).



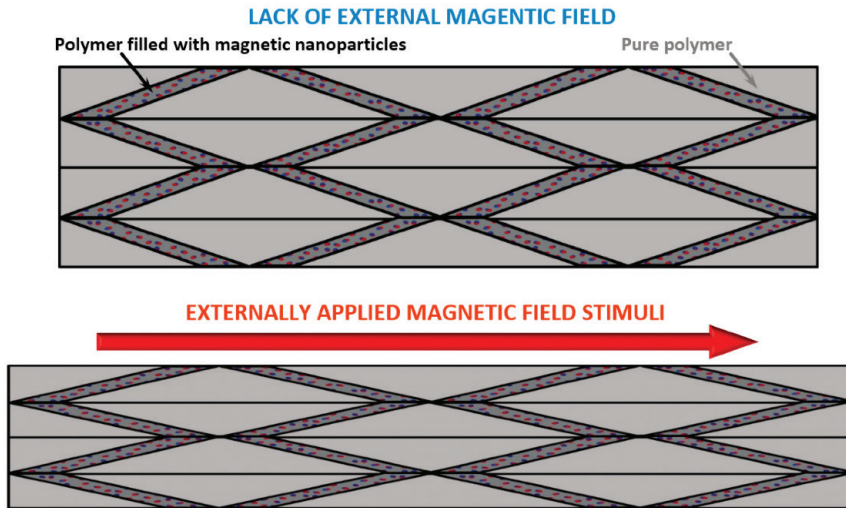


**Figure 8.** Comparison between 4D and 6D printing: When the 6D printing technique is used instead of the 4D one, the bending deformation of a printed component is enhanced owing to heat stimulation.

Six-dimensional (6D) printing concept is likely to be quickly embraced by the industry because of its benefits that make the appropriate materials and printing equipment, as well as other additive manufacturing end-users. The aerospace sector, medical devices and electronics, operational components for energy applications, and other industries where precision is crucial might benefit from this method's use due to the 6D printing method's enhanced structural and functional possibilities and projected higher processing accuracy (Ghazal et al., 2022; Georgantzinos et al., 2021).

Figure 9 shows an example of a possible related 6D printed product. The specimen has a complicated structure that includes inclined layers of pure polymer and nano-reinforced polymer. A polymer matrix material loaded with magnetic nanoparticles forms each nanocomposite layer. Because of the common orientation of the nanoparticles and the form of layering, the specimen becomes substantially stretched in one direction due to the utilization of a strong magnetic field and the aforementioned structural properties obtained by 6D printing. The process settings can be modified to create smart material components that are more flexible while also being stronger (Georgantzinos et al., 2021).





**Figure 9.** An example of 6D printing. The inclined complex layering technique, which combines pure and nano-reinforced polymeric layers, enables a rapid response to a magnetic stimulus (Georgantzinis et al., 2021).

In the health sector, bones have a curved surface rather than a flat surface, rotating the bed to follow the curvature is critical, and the generated smart materials could be employed for smart medical implants in difficult medical circumstances. In construction, 6D printing could be used to produce self-repairing and self-adapting systems and goods, such as a pipe that uses smart materials to alter diameter and quality dynamically in reaction to water pressure. 6D printing could be also utilized in aerospace engineering to generate curved materials that can reshape in response to temperature changes (Ghazal et al., 2022; Georgantzinis et al., 2021).

The primary distinction between 3D and 5D printing is that 5D printing produces a stronger part with a curved layer, whereas 3D printing produces a flat surface. Both processes make use of the same technology, such as 3D CAD file input, and 3D printing material. 6D printing, on the other hand, is not like these two technologies. It's similar to 4D printing in that it employs several types of programmable materials that can alter shape and function in response to time and temperature. Because of their thermo-mechanical qualities, these materials are referred to as smart materials (Haleem et al., 2019; Anas et al., 2021; Haleem and Javaid, 2019a; Haleem and Javaid, 2019a; Haleem and Javaid, 2019b).

#### 4. CONCLUSION

The evolution of 3D printing technology to 6D technology is examined in this paper. 5D printing has evolved and grown widely in future technology which has the 4th axis is the rotation of the extruder

head and the 5th axis is the rotation of the print bed to print in 5 different axes. We can create a curved layer using 5D printing. The research is still going on the 5D printing technology in medical treatment, manufacturing of components, etc. This technology, like 3D and 4D printing, has the potential to revolutionize orthopedics in the future. It will open up a world of possibilities and deliver outstanding service to preserve the patient's life.

Intense research is taking on in the field of additive manufacturing, resulting in new 3D printing trends such as 4D and 5D printing. 6D printing technology has the potential to disrupt various industries in the future, including the medical field, construction, aerospace engineering, and manufacturing industry. Six-dimensional printing (or 6D printing) is a hybrid of four-dimensional (4D) and five-dimensional (5D) printing techniques. The primary focus is on smart materials, stronger materials, and less material utilization, resulting in minimal or no machining.

In the future, both 5D and 6D printing technology will be quite useful. These technologies have the potential to transform the medical and automobile industries, as well as biomedical and orthodontic devices, in response to human growth. This developing technology will grow more advantageous in the future, allowing for limitless possibilities in medical, car, and other industries.

## REFERENCES

- Ahmed, A., Arya, S., Gupta, V., Furukawa, H., & Khosla, A. (2021). 4D printing: Fundamentals, materials, applications and challenges. *Polymer*, 228, 123926.
- Anas, S., Khan, M. Y., Rafey, M., & Faheem, K. (2022). Concept of 5D printing technology and its applicability in the healthcare industry. *Materials Today: Proceedings*, 56, 1726-1732.
- Auffray, L., Gouge, P. A., & Hattali, L. (2021). Design of experiment analysis on tensile properties of PLA samples produced by fused filament fabrication. *The International Journal of Advanced Manufacturing Technology*, 1-15.
- Feng, X., Cui, B., Liu, Y., Li, L., Shi, X., & Zhang, X. (2021). Curved-layered material extrusion modeling for thin-walled parts by a 5-axis machine. *Rapid Prototyping Journal*, 1378-1387.
- Georgantzinou, S. K., Giannopoulos, G. I., & Bakalis, P. A. (2021). Additive Manufacturing for Effective Smart Structures: The Idea of 6D Printing. *Journal of Composites Science*, 5(5), 119.
- Ghazal, A. F., Zhang, M., Mujumdar, A. S., & Ghamry, M. (2022). Progress in 4D/5D/6D printing of foods: applications and R&D opportunities. *Critical Reviews in Food Science and Nutrition*, 1-24.
- Gobbato, B. B. (2019). Setting up your own home 3D printing “plant”. In *3D printing in orthopaedic surgery* (pp. 195-208). Elsevier.
- Gordelier, T. J., Thies, P. R., Turner, L., & Johanning, L. (2019). Optimising the FDM additive manufacturing process to achieve maximum tensile strength: a state-of-the-art review. *Rapid Prototyping Journal*.
- Gunpinar, E., & Cam, S. (2022). 4 and 5-Axis additive manufacturing of parts represented using free-form 3D curves. *Graphical Models*, 120, 101137.
- Haleem, A., & Javaid, M. (2019a). Future applications of five-dimensional printing in dentistry. *Current Medicine Research and Practice*, 9(2), 85-86.
- Haleem, A., & Javaid, M. (2019b). Expected applications of five-dimensional (5D) printing in the medical field. *Current Medicine Research and Practice*, 9(5), 208-209.
- Haleem, A., Javaid, M., & Vaishya, R. (2019). 5D printing and its expected applications in Orthopaedics. *Journal of Clinical Orthopaedics & Trauma*, 10(4), 809-810.
- Kumaresan, R., Samykano, M., Kadirgama, K., Ramasamy, D., Keng, N. W., & Pandey, A. K. (2021). 3D Printing Technology for Thermal Application: A Brief Review. *Journal of Advanced Research in Fluid Mechanics and Thermal Sciences*, 83(2), 84-97.
- Lee, A. Y., An, J., & Chua, C. K. (2017). Two-way 4D printing: a review on the reversibility of 3D-printed shape memory materials. *Engineering*, 3(5), 663-674.

- Mandala, R., Bannoth, A. P., Akella, S., Rangari, V. K., & Kodali, D. (2022). A short review on fused deposition modeling 3D printing of bio-based polymer nanocomposites. *Journal of Applied Polymer Science*, 139(14), 51904.
- Reddy, P. R., & Devi, P. A. (2018). Review on the advancements of additive manufacturing-4D and 5D printing. *Int J Mech Prod Eng Res Dev*, 8(4), 397-402.
- Zharylkassyn, B., Perveen, A., & Talamona, D. (2021). Effect of process parameters and materials on the dimensional accuracy of FDM parts. *Materials Today: Proceedings*, 44, 1307-1311.



## **CHAPTER 11**

### **BIOMIMETIC STUDIES IN MECHANICS**

*Berkant DİNDAR<sup>1</sup>*

---

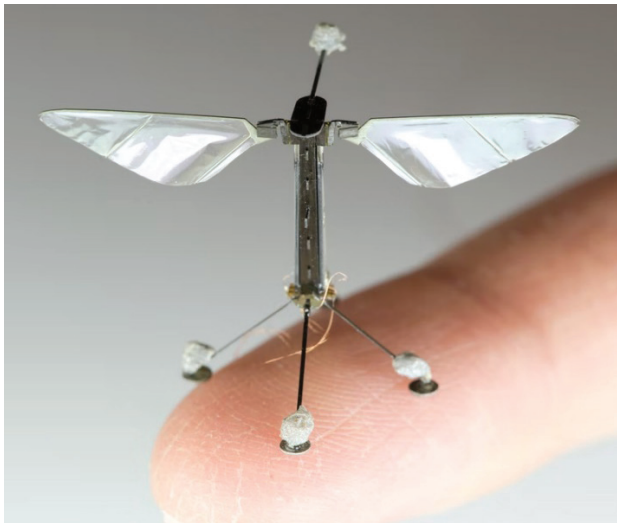
<sup>1</sup> Asst. Prof. Berkant DİNDAR, Tokat Gaziosmanpaşa University, Faculty of Engineering and Architecture, Mechanical Engineering Department (orcid:0000-0003-1215-3621)

The science of biomimetics is applied to daily life by imitating the mechanisms that nature has developed spontaneously over hundreds of thousands of years according to environmental conditions. Biomimetic uses the information obtained by systematically examining the evolutionary processes and structural relationships of living things to produce new products and materials to make people's lives easier [1]. Scientists engineers and experts from many different disciplines work together for this purpose.

Biomimetic examples in the field of mechanics developed in recent years;

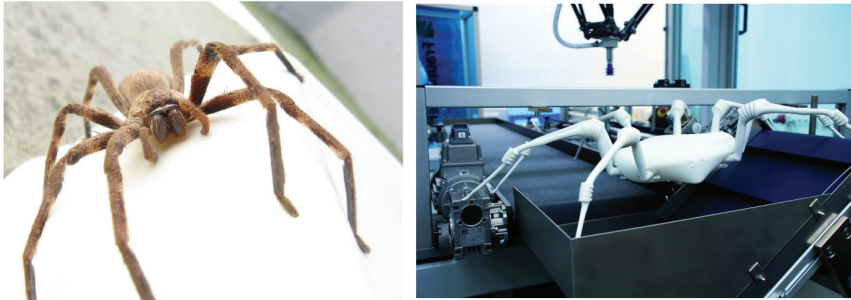
### *Insects and Robotics*

With the development of technology, some breakthroughs in the field of robotics have gained momentum. Micro air vehicles constitute an important place among the breakthroughs in this field. Micro flying robots produced by imitating insects can be given as a good example of biomimetic designs in the field of mechanics. The dimensions of these robots are in the range of 5-15 cm. With the advantages of their size, they can work in military and civilian areas in conditions where different robotic mechanisms will not work. By adding equipment such as microphones and cameras to these micro-sized robots, sound and image acquisitions from areas that are physically difficult to access can be obtained. Micro air vehicles can be in different designs according to the wing types. These designs are generally divided into three as fixed, rotating and flapping wings. Although fixed and rotary wing vehicles are used extensively today, flapping wing vehicle technology is newly developing. Figure 1 show the flapping wing micro vehicle developed by WYSS Institute [2].



**Figure 1:** *Micro air vehicle [2].*

On the other hand, engineers who study the leg and body structure of spiders and some other insects use it in military-purpose robots. A robot that can withstand adverse geographical conditions such as terrain and bad weather conditions must have a leg structure just like a spider. Because features such as walking, jumping and being able to move independently of each other make it easier to adapt to these conditions. The prototype spider developed by researchers at the Fraunhofer Institute is shown in Figure 2.



**Figure 2:** Spider and biomimetic model [3, 4].

### ***Gecko Lizard and Climbing Shoes***

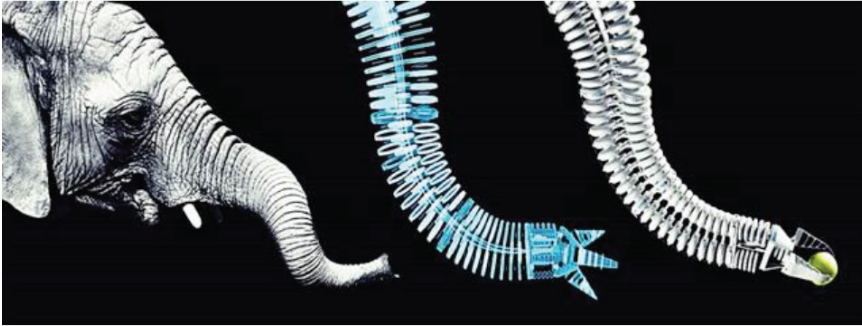
Imitation of the gecko, a lizard species living in humid tropical regions, has revealed mountain eering shoes. The gecko is a class of lizards whose feet soles are comprised of lamellae, which further may be classified into oriented minute hair known as setae. The setae multiply into thousands of ‘flat-ended’ structures, thus enhancing the surface area of the feet. Gecko’s feet do not have any sticky substance. Instead, it has nano-level force exhibited by each of the small spatulate shaped structures on each setae. The summation of these nanometric forces is so strong that, theoretically, a gecko may add 40 kilograms of weight and still be able to climb walls profoundly [5, 6]. The gecko lizard and the shoes inspired by this lizard are shown in Figure 3.



**Figure 3:** Gecko lizard and biomimetic shoes [7].

### ***Elephant Trunk and Precision Robotic Arm***

A robotic arm was developed by the German company Festo, inspired by the elephant trunk (Figure 4). One of the most important features of the robot arm is that it is produced entirely with plastic parts, without using any metal. The robot arm generally consists of three main parts. Each part has the ability to both rotate and stretch in all directions. The movement is provided by the air movement passing between the plastic parts. The sensors in the robot arm are designed to prevent any accident immediately [8].

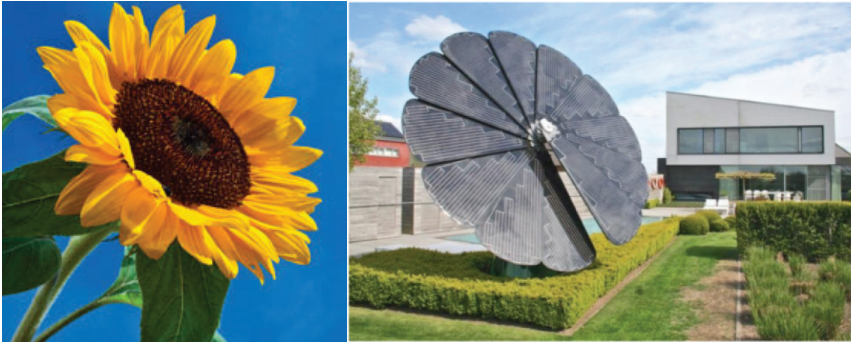


**Figure 4:** *Elephant trunk and byomimetic precision robot arm [8].*

### ***Sunflower and Movable Solar Panels (Smartflower)***

It is a very interesting natural phenomenon that the sunflowers in the development period follow the sunlight during the day. Inspired by this interesting phenomenon Austrian-based Smartflower Energy Technology has developed a panel that opens like a flower and follows the sun throughout the day (Figure 5). When the Smartflower is closed, it resembles a large box. With the sun rise, this box opens and leaf designed photovoltaics panels come out. When the panels are fully opened, the motor system at the base turns the panels into the sun, enabling the start of energy production. The sweeper mechanism on the underside of the panels automatically performs the task of collecting dust and dirt accumulated on the panels as the leaves are opened. The Smartflower produces the equivalent of a 4 kW roof system. Because the Smartflower always receives the light vertically, it can work around 40-50 percent more efficiently than a fixed setup of similar size [9].





**Figure 5:** *Sunflower and biomimetic movable solar panels [9, 10].*

### ***Frog Foot Pads and Auto Tires***

Figure 6 shows the tire produced by Continental, inspired by frog foot pads. The tree frog is known for climbing wet trees and the thtorrent frog is known for climbing wet surfaces near waterfalls. The ContinentalConti WinterContact™ TS 780 has better wet driving performance, optimum handling and shorter stopping distance. These features were obtained as a result of giving a hexagonal pattern to the tire by imitating the surface structure of the foot pads of the tree frog and thetorrent frog species. The “V” Pattern shape, on the other hand, reduces the risk of aquaplaning by quickly evacuating the water on the tire [11].



**Figure 6:** *Biomimetic tire inspired by frogs toe pads [11,12].*

### ***Robot Dog Spot***

In Figure 7, the dog-like robot named spot produced by Boston Dynamics, is seen. Spot weighs 25 kg and is 83 cm tall. Spot, which has a load carrying 14 kg, can move at a speed of 1.6 km. It can collect images with its advanced camera system in environments that may be dangerous for people, it can detect hot spots that may cause problems in machines or

electrical conductors with its thermal camera, and it can map the desired environments with its laser scanner.

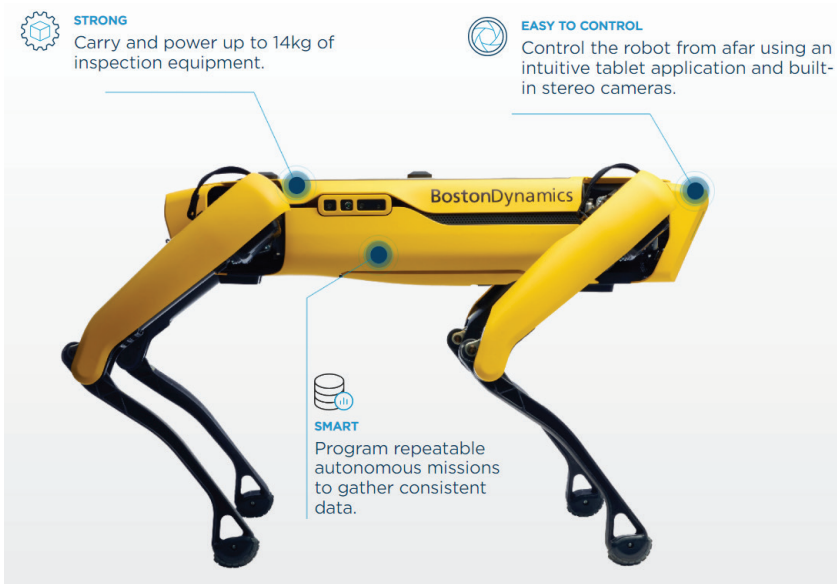


Figure 7: Robot dog spot [13].

### *Pomelo Inspired Helmets*

BMW company developed a new helmet for its employees, imitating a pamelos (Figure 8). The design was developed by the BISS (Bio-Inspired Safety Systems) research Project. Designed with inspiration from nature, this product provides up to 20 % better protection. They achieved this by copying the damper feature of the Pamelos fruit. For example, when fruit falls from a high tree, it is not damaged and protects its interior [14].



Figure 8: Pomelo Inspired Helmets [14].

### ***Bionic Boots Inspired by Ostriches***

Ostriches are the fastest running bipeds. Their speed can reach over 60 km/h. Keahi Seymour developed bionic boots inspired by ostriches. He worked on these boots for about 30 years and produced over 200 different prototypes. Finally, it was able to reduce the weight of the boots to 2.72 kg and reached 40 km/h speed with these boots (Figure 9) [15].



**Figure 9:** *Bionic boots inspired by ostriches* [16].

### ***Shark Skin and Swimsuits***

Speedo developed a new design by examining the skin characteristics of sharks (Figure 10). Shark skin has tiny structures that can be seen under the electron microscope. These structures, also called small skin teeth, are composed of grooves whose length can align with the flow of water. These grooves disrupt the turbulent eddies of water, allowing it to pass faster. Thanks to technology, speedo reduces the friction during swimming by 6 %, allowing the swimmer to swim faster [17].



**Figure 10:** *Swimsuit developed by imitating sharks* [17].

## REFERENCES

- [1] Ivanović, L., Vencl, A., Stojanović, B., Marković, B., (2018). Biomimetics Design for Tribological Applications, 40(3), 448-456, DOI: 10.24874/ti.2018.40.03.11
- [2] <https://wyss.harvard.edu/technology/robobeets-autonomous-flying-microrobots/> (05.06.2022)
- [3] [https://en.wikipedia.org/wiki/Huntsman\\_spider#/media/File:Sparassidae\\_Palystes\\_castaneus\\_mature\\_female\\_9923s.jpg](https://en.wikipedia.org/wiki/Huntsman_spider#/media/File:Sparassidae_Palystes_castaneus_mature_female_9923s.jpg) (05.06.2022)
- [4] <https://www.fraunhofer.de/en/press/research-news/2011/november/high-tech-spider.html> (05.06.2022)
- [5] B., Sayan, (2020) Walking through the biomimetic bandages inspired by Gecko's feet. *Bio-Design and Manufacturing*. 3, 148–154.
- [6] Zhenhai X et al (2018) Temperature-induced tunable adhesion of gecko setae/spatulae and their biomimics. *Mater Today Proc* 5(12):25879–25893
- [7] <http://www.globalstewards.org/biomimicry-nine-laws-of-nature.htm>
- [8] Festo, Bionic Handling Assistant, 1-6.
- [9] <https://www.xtrlarge.com/2017/05/12/gunes-enerji-teknoloji-cicek-smartflower/> (15.06.2022)
- [10] <https://www.chemistryworld.com/news/solar-cell-meets-sunflower/5312.article>
- [11] Ivanović L., Vencl, A., Stojanović, B., Marković, B., (2018). Biomimetics Design for Tribological Applications, *Tribology in Industry*, 40,(3), 448-456, DOI: 10.24874/ti.2018.40.03.11
- [12] <https://www.thetirelab.com/continental-contiwintercontact-ts-780/> (15.06.2022)
- [13] [https://www.bostondynamics.com/products/spot#id\\_first](https://www.bostondynamics.com/products/spot#id_first) (15.06.2022)
- [14] <https://www.press.bmwgroup.com/global/article/detail/T0272248EN/inspired-by-nature-new-body-protection-for-bmw-employees?language=en> (15.06.2022)
- [15] <https://thehustle.co/bionic-boot/> (15.06.2022)
- [16] <https://www.core77.com/posts/42320/Bird-Biology-Inspired-Bionic-Boots> (15.06.2022)
- [17] <https://netvent.com/> (15.06.2022)



## **CHAPTER 12**



### **EFFECT OF OPTIMIZATION METHODS ON OPTIMUM DESIGN OF TUNED MASS DAMPER FOR MULTI-STORY STRUCTURES**

*Onur ARAZ<sup>1</sup>*

---

<sup>1</sup> Asst. Prof. Dr. Onur ARAZ, Gümüşhane University, Faculty of Engineering and Natural Sciences, Department of Civil Engineering, Gümüşhane, Turkey, e-mail: onuraraz29@hotmail.com, ORCID ID: 0000-0002-6218-0559

## 1 Introduction

Elements added to the structure in order to reduce the vibrations in the structures to acceptable levels are called structural control systems (i.e., active, passive, hybrid and semi-active). These systems are mostly used to reduce vibrations in structures under the earthquake, wind and moving forces. Therefore, reducing vibrations in structures under earthquake excitations, wind loads and traffic loads has long been an important study topic for researchers (Wang et al., 2003; Liu et al., 2008; Luu et al., 2012; Kahya and Araz 2017; Kahya and Araz 2020; Araz and Kahya 2020; Araz and Kahya 2021; Araz and Kahya 2022). Tuned mass damper (TMD), a class of passive systems, is used in many types of structures, especially tall buildings. Low maintenance cost, no need for external energy and high effectiveness can be given among the reasons for the widespread use of TMDs (Araz, 2020). TMDs usually consist of a mass placed in the top level of the structures and a spring and damper element that connects this mass to the main structure. They reduce structural deformations and damage by acting in the opposite direction of the displacement of the building. In the optimum design of a TMD placed at the top of the building, the dominant mode of the structure is considered. Then, by choosing a certain mass ratio, the optimum values of the elements connecting the TMD to the structure are calculated.

The TMD concept was first introduced by Frahm to minimize the vibrations induced by ship machinery on the ship's keel. Frahm named this device, which he patented in 1911, as tuned mass in those years. This device proposed by Frahm was only effective in a narrow frequency range since it did not have a damping element. Ormondroyd and Den Hartog (1928) made the first theoretical work on tuned mass dampers. The most comprehensive study of the optimum design of TMD was done by Den Hartog (1956). This work, it is aimed to reduce vibrations in the undamped structure under harmonic excitations by using TMD. In addition, some empirical formulas based on the mass ratio have been proposed for the optimization of the TMD. Then, the optimum parameters of TMD are obtained for different external loads considering the damping ratio of the main structure (Araz and Kahya 2018).

Errors that occur in the frequency of the structure adversely affect the effectiveness of the TMD. This situation is called the detuning effect. Xu and Igusa (1992) suggested using more than one TMD tuned to different frequencies against frequency deviation. These systems are divided into two as serial and parallel according to the type of connection. In parallel TMDs, the total number of TMDs varies between 3 and 10. Previous studies have shown that the use of TMD above this number does not increase control performance much (Fujino and Abe 1993; Rana and



Song 1998; Li and Zhu 2006; Bakre and Jangid 2007). On the other hand, series TMDs consist of two TMDs connected in series to each other. Both control systems are successfully used to reduce vibrations in structures under the influence of wind, earthquake and traffic loads.

Most of the previous studies on TMD focus on obtaining optimum parameters (Ghosh and Basu 2007; Marano et al., 2010; Daniel et al., 2012; Anh et al., 2013; Bekdaş and Nigdeli 2013; Elias 2018; Cetin and Aydin 2019; Elias et al., 2019; Araz et al., 2022). For this purpose, different optimization methods are used in the tuning parameters of TMD. But the main issue here is which optimization method produces faster and more effective results. Therefore, the effect of different optimization algorithms on the optimization of TMD is investigated in this work. The effectiveness of TMD has been verified by analyzes performed on a 10-storey building under the different earthquake records. TMD is installed on the top story of the structure in order to reduce vibrations. In addition, four different optimization methods (i.e., Sequential quadratic programming (SQP), Simulated annealing (SA), Pattern Searching algorithm (PSA) and Particle swarm optimization (PSO)) are used to obtain the optimum parameters of the TMD.

## 2 Structural Model

A ten-story shear building with a TMD added to the top floor is given in Fig. 1. The equation of motion for the considered problem is given in Eq. (1).

$$\mathbf{M}\ddot{\mathbf{x}}(t) + \mathbf{C}\dot{\mathbf{x}}(t) + \mathbf{K}\mathbf{x}(t) = -\mathbf{m}\ddot{\mathbf{x}}_g(t) \quad (1)$$

where,  $\mathbf{M}$ ,  $\mathbf{C}$  and  $\mathbf{K}$  denote the mass, damping and stiffness matrices of the structure, respectively.  $\mathbf{x}(t)$  is the displacement vector.  $m_{tmd}$ ,  $c_{tmd}$  and  $k_{tmd}$  indicate the mass, damping coefficient and stiffness of the TMD, respectively.

$$\mathbf{M} = \text{diag}[m_1 \quad m_2 \quad \cdots \quad m_{10} \quad m_{tmd}] \quad (2)$$

where

$$\mathbf{C} = \begin{bmatrix} c_1 + c_2 & -c_2 & & & & & & & & & & \\ -c_2 & c_2 + c_3 & -c_3 & & & & & & & & & \\ & & \ddots & \ddots & \ddots & & & & & & & \\ & & & \ddots & \ddots & \ddots & & & & & & \\ & & & & \ddots & \ddots & \ddots & & & & & \\ & & & & & \ddots & \ddots & \ddots & & & & \\ & & & & & & -c_{10} & c_{10} + c_{tmd} & -c_{tmd} & & & \\ & & & & & & & & & c_{tmd} & & \\ & & & & & & & & & & & \text{sym} \end{bmatrix} \tag{3}$$

$$\mathbf{K} = \begin{bmatrix} k_1 + k_2 & -k_2 & & & & & & & & & & \\ -k_2 & k_2 + k_3 & -k_3 & & & & & & & & & \\ & & \ddots & \ddots & \ddots & & & & & & & \\ & & & \ddots & \ddots & \ddots & & & & & & \\ & & & & \ddots & \ddots & \ddots & & & & & \\ & & & & & \ddots & \ddots & \ddots & & & & \\ & & & & & & -k_{10} & k_{10} + k_{tmd} & -k_{tmd} & & & \\ & & & & & & & & & k_{tmd} & & \\ & & & & & & & & & & & \text{sym} \end{bmatrix} \tag{4}$$

$$\mathbf{x}(t) = [x_1 \quad x_2 \quad \cdots \quad x_{10} \quad x_{tmd}]^T \tag{5}$$

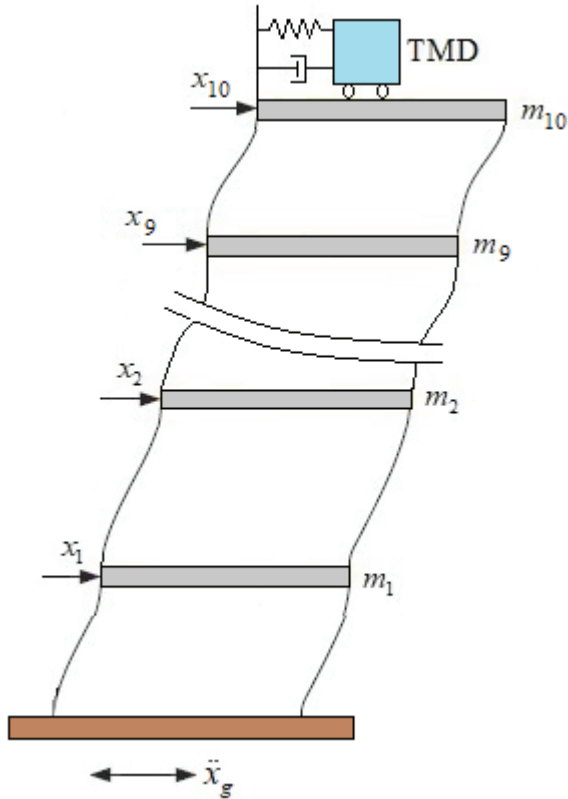
$$\mathbf{m} = [m_1 \quad m_2 \quad \cdots \quad m_{10} \quad m_{tmd}]^T \tag{6}$$

The optimum parameters are obtained in the frequency domain and the objective function (**OF**) is presented in Eq. (8). The aim of the optimization is to reduce the amplitude of the transfer function ( $TF_{10}$ ) at the top story of the structure.

$$\mathbf{TF}(\omega) = [-\mathbf{M}\omega^2 + \mathbf{C}i\omega + \mathbf{K}]^{-1} \mathbf{m} \tag{7}$$

$$\mathbf{OF} = \max |TF_{10}(\omega)| \tag{8}$$





*Fig. 1. Ten-story shear building with TMD.*

### 3 Optimization Procedure

In this section, information about the optimization problem and the methods used in optimization is given. The optimization problem is defined as:

$$\begin{aligned}
 &\text{find } \tilde{\delta}_{opt} \text{ and } \tilde{i}_{opt} \\
 &\text{min } \max |TF_{10}(\dot{u})| \\
 &\text{s.t } 0.8 \leq \tilde{\delta} \leq 1.2 \\
 &\quad 0.0 \leq \tilde{i} \leq 0.4
 \end{aligned} \tag{9}$$

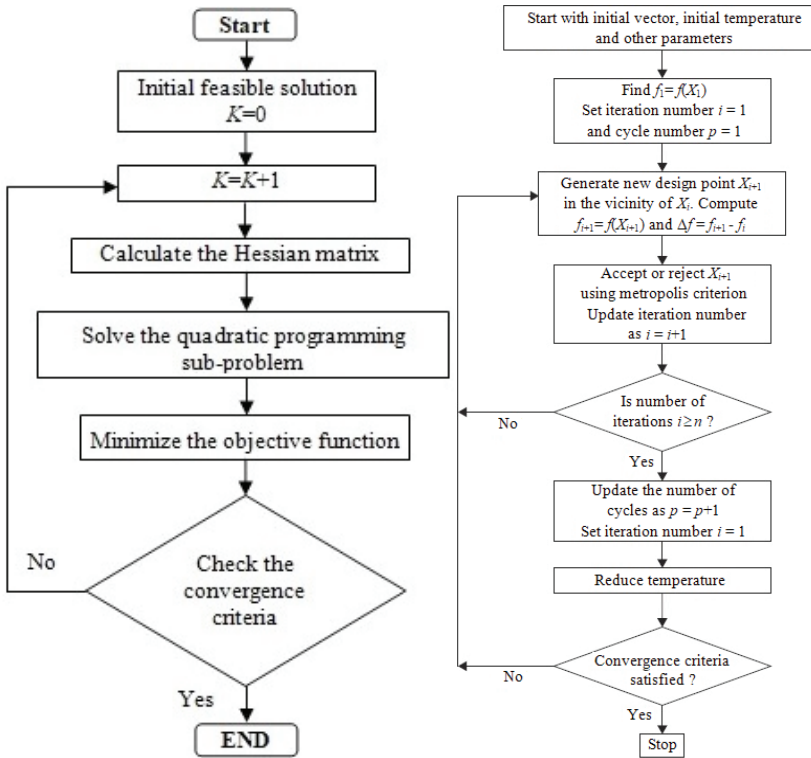
where  $\max TF_{10}$  is the maximum amplitude of the top story of the structure. The optimum damping ratio and frequency ratio of the TMD is given in Eq. (9), respectively.

$$\xi_{opt} = \frac{c_{tmd}}{2m_{tmd}\omega_{tmd}}, \quad \nu_{opt} = \frac{\omega_{tmd}}{\omega_{1,s}} = \frac{\sqrt{k_{tmd} / m_{tmd}}}{\omega_{1,s}} \tag{10}$$

The mass ratio of the TMD is expressed by

$$\mu = \frac{m_{tmd}}{M_{1,s}} \tag{11}$$

where  $\omega_{1,s}$  and  $M_{1,s}$  represent the first natural frequency and the first modal mass of the structure, respectively.



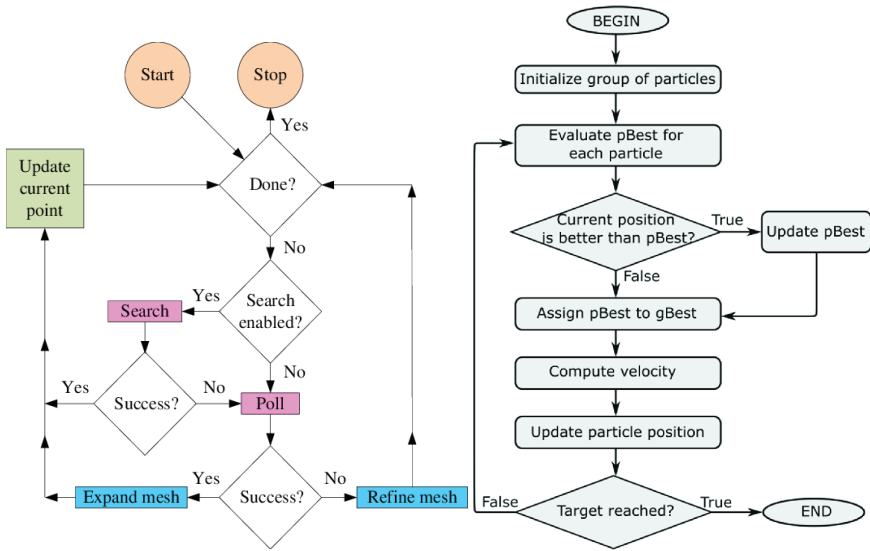
(a) SQP (Araz and Kahya, 2020)

(b) SA (Araz and Kahya, 2021)

Fig. 2 The flowcharts of SQP and SA.

The fact that the concepts of both safety and cost, which are among the main elements of engineering designs, are tried to be provided in the design has enabled the optimization applications to be used frequently in

engineering. In addition, the need to provide fast and effective solutions can be cited as the main reasons for introducing different optimization methods. For this purpose, it is seen that many optimization methods are used especially in the optimization of engineering problems. In recent years, metaheuristic methods have been used in the methods developed for optimization applications in civil engineering. These methods are inspired by various events that occur in nature. Three of them are included in this study. They are Simulated annealing (SA), Pattern Searching algorithm (PSA) and Particle swarm optimization (PSO). The results obtained for these methods are also compared with the results of the gradient-based optimization method (SQP). The methods are compared based on the total processing time, the total number of iterations and the peak value of the objective function.



(a) PSA (Fu et al., 2015)

(b) PSO (Le et al., 2019)

Fig. 3 The flowcharts of PSA and PSO.

#### 4 Numerical Examples

The effect of TMD in reducing the structural responses of a 10-storey building under earthquake will be investigated. The building properties are  $m_1 = m_2 = \dots = m_{10} = 125 \text{ t}$ ,  $c_1 = c_2 = \dots = c_{10} = 1.41 \text{ MNs/m}$ ,  $k_1 = k_2 = \dots = k_{10} = 221 \text{ MN/m}$ . The properties about the earthquakes used in the study is shown in Table 1. The acceleration records of the Erzincan earthquake, the Loma Prieta earthquake, the Duzce earthquake and the Parkfield earthquake are shown in Fig. 4, respectively. The mass of the TMD is 53t which is equal to 5% of the first modal mass of the building.

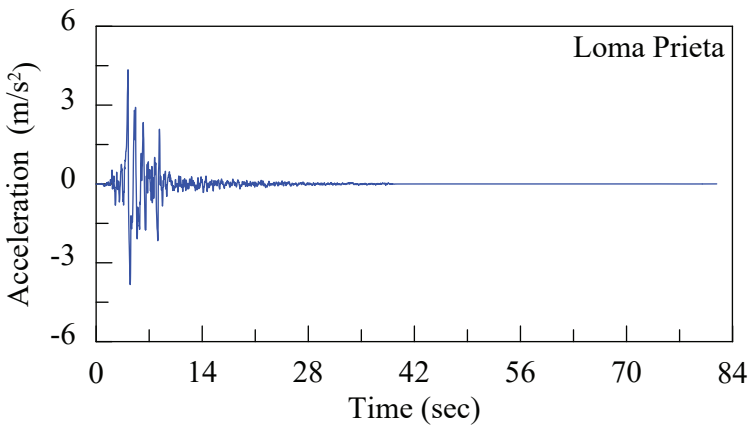
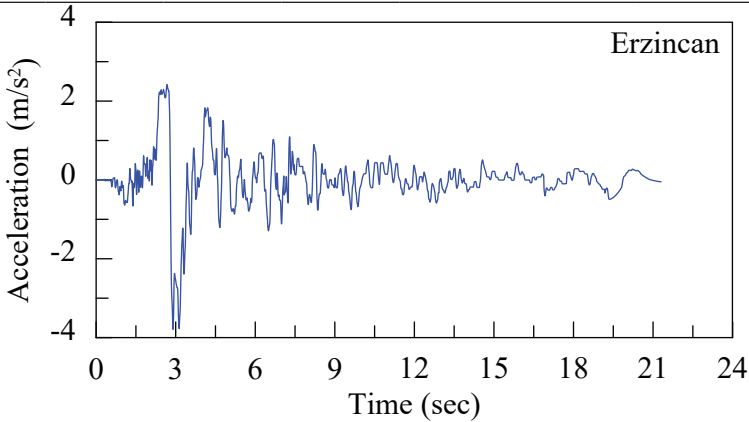
The optimization results for different optimization methods are given in Table 2. As can be seen, although all optimization methods provide similar performance, SQP and PSA provide faster solutions than other methods.

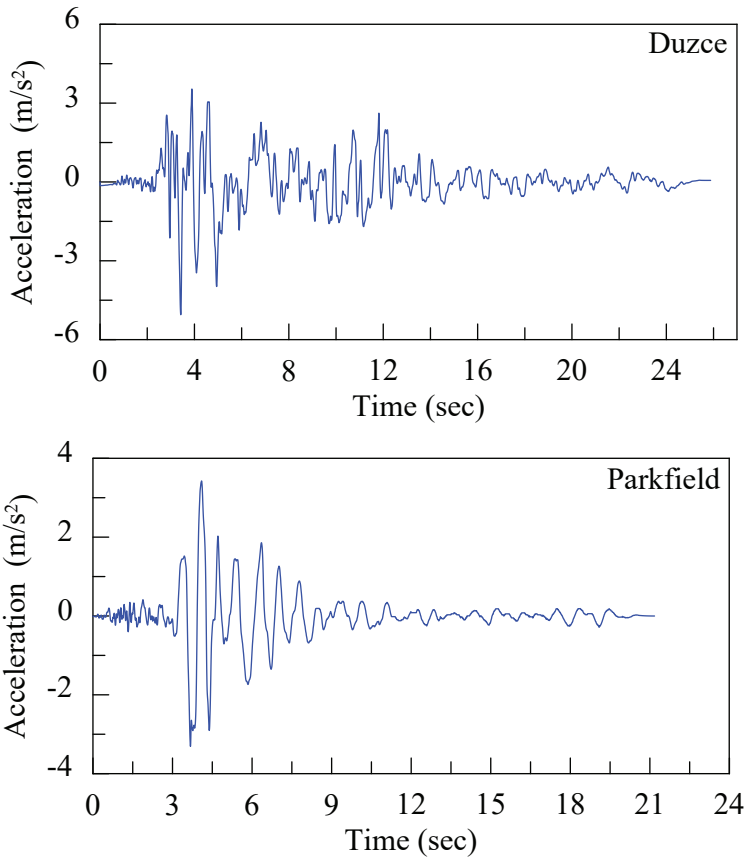
**Table 1.** The properties of the earthquakes.

Record name	Station	Peak Ground Acceleration (PGA)
Erzincan	Erzincan	0.390
Loma Prieta	Los Gatos-Lexington Dam	0.443
Duzce	Duzce	0.515
Parkfield	Slack Canyon	0.349

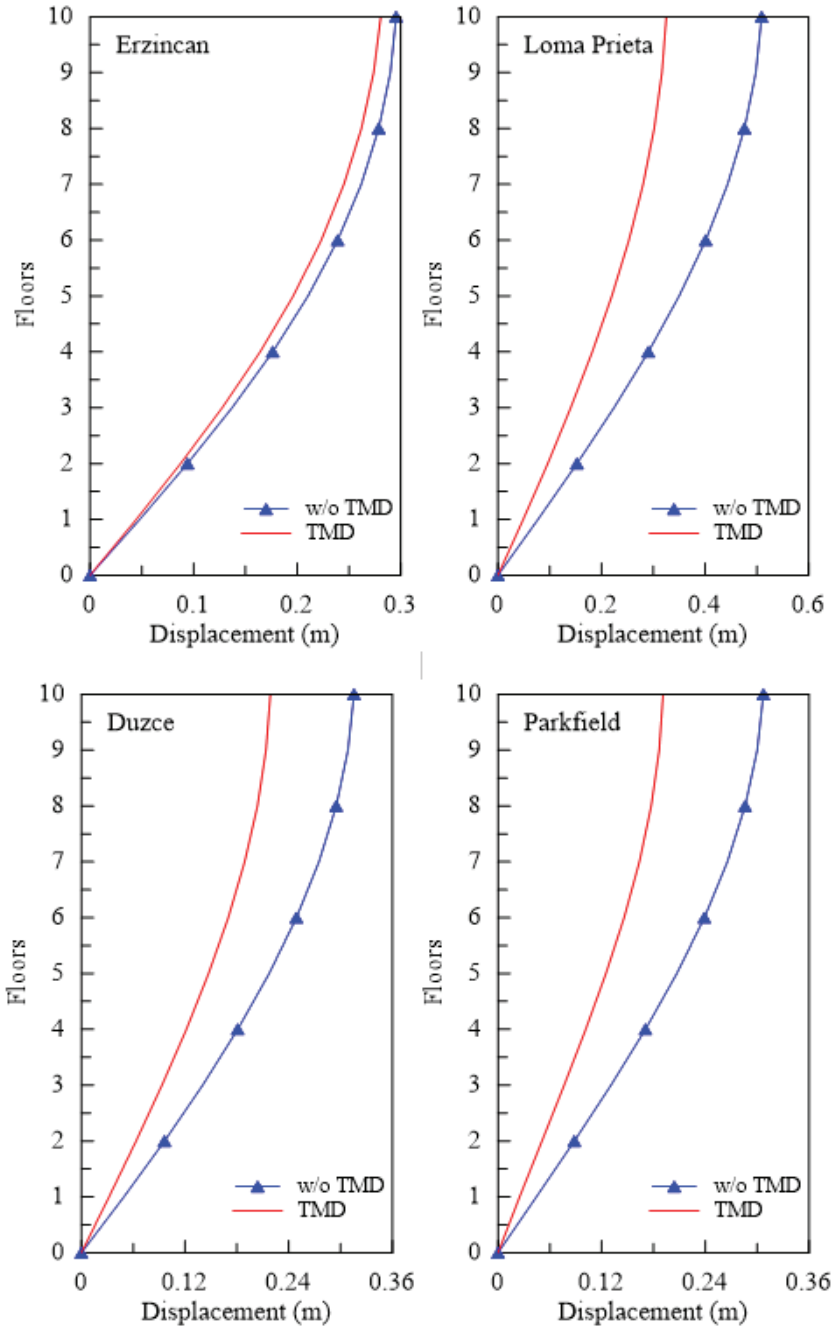
**Table 2.** The optimization results for different optimization methods.

Method	Peak OF	$\tilde{\theta}_{opt}$	$\hat{t}_{opt}$	Number of iterations	Total time (s)
SQP	0.1472	0.9019	0.1766	24	1.90
SA	0.1478	0.9013	0.1669	2091	16.17
PSA	0.1473	0.9023	0.1812	64	1.94
PSO	0.1472	0.9019	0.1766	48	6.69

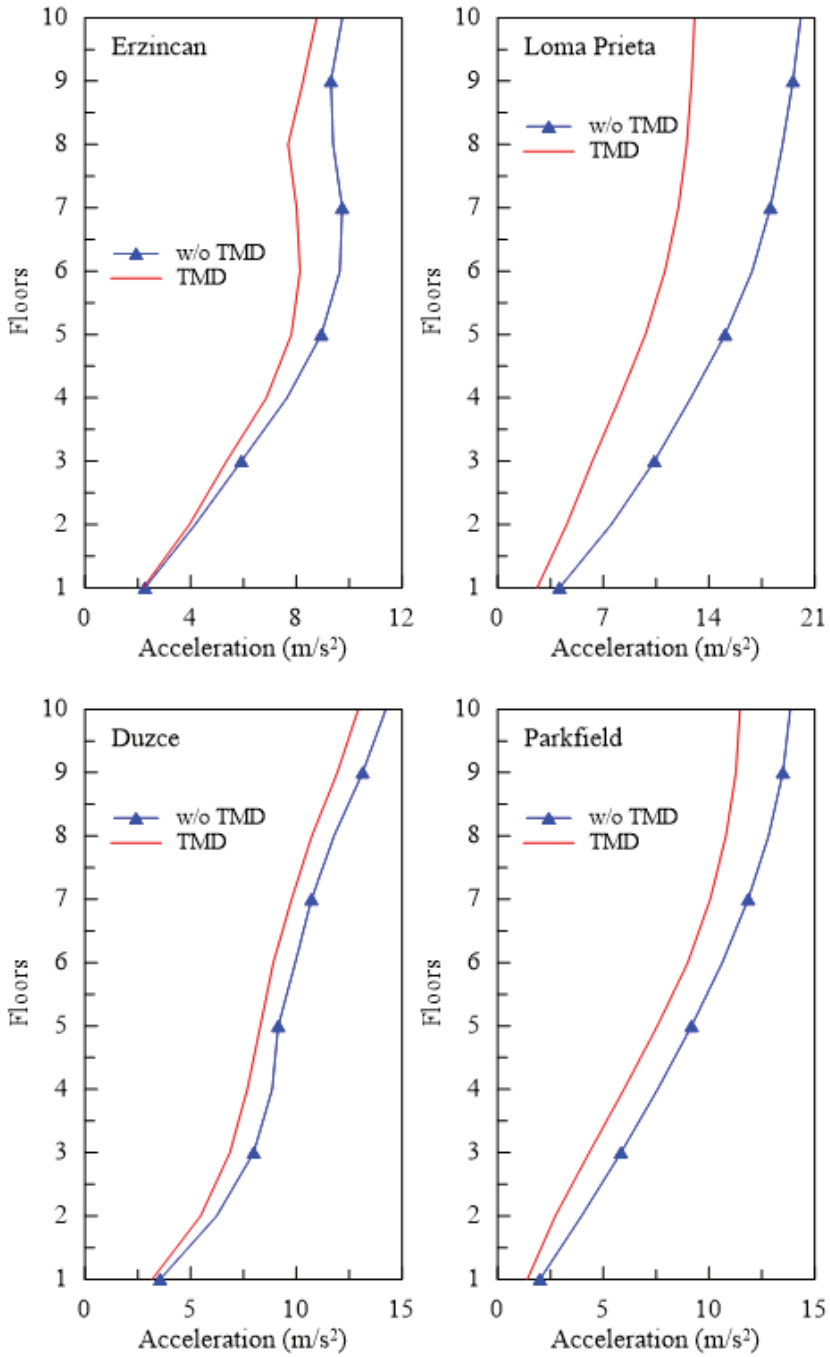




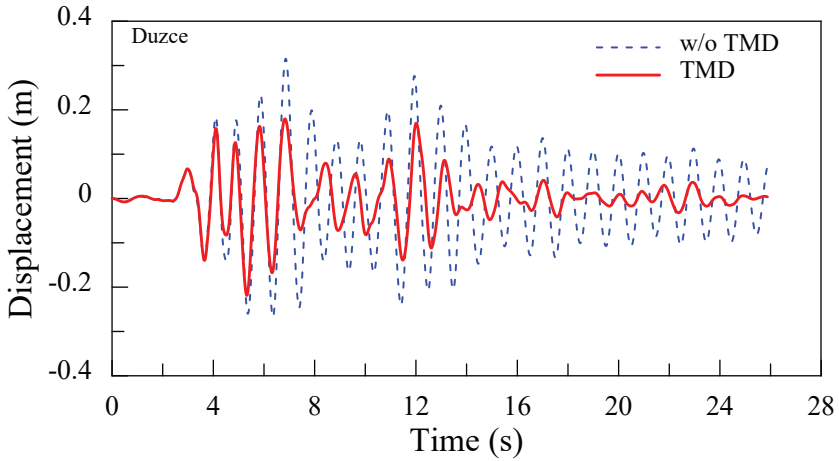
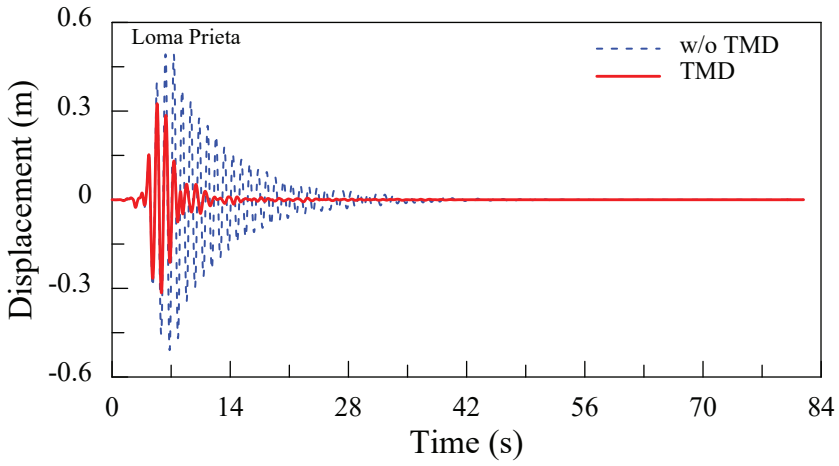
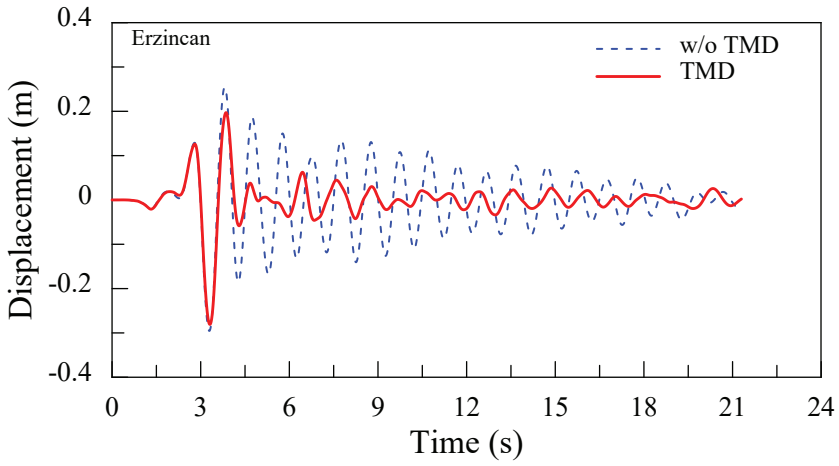
**Fig. 4.** The acceleration record of the selected earthquakes.



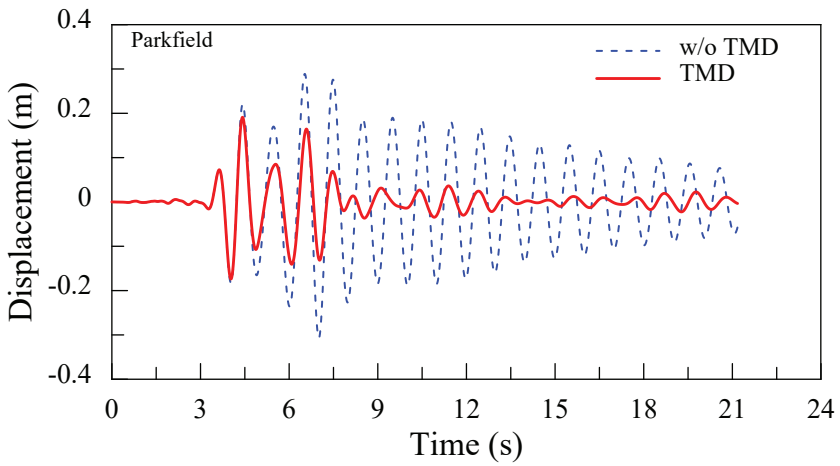
*Fig. 5. The maximum displacement of floors under various earthquakes.*



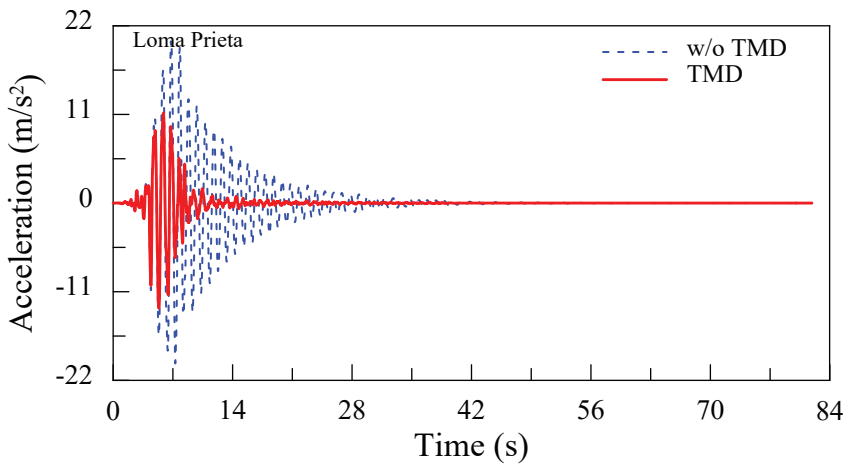
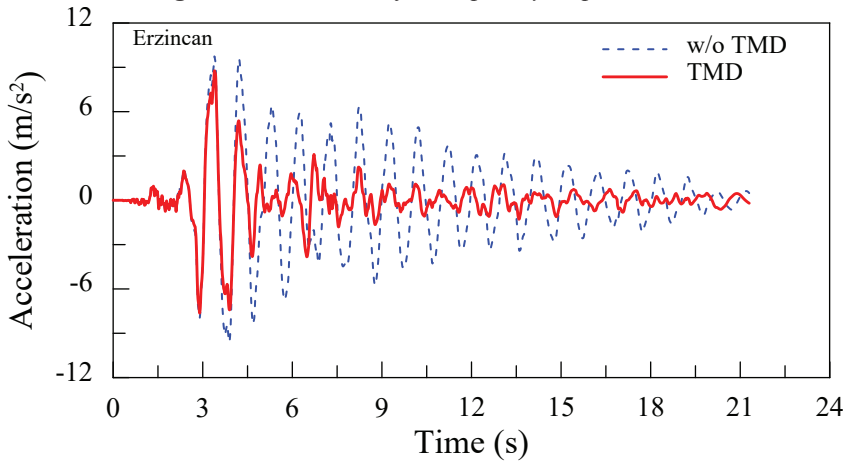
**Fig. 6.** The maximum acceleration of floors under various earthquakes.

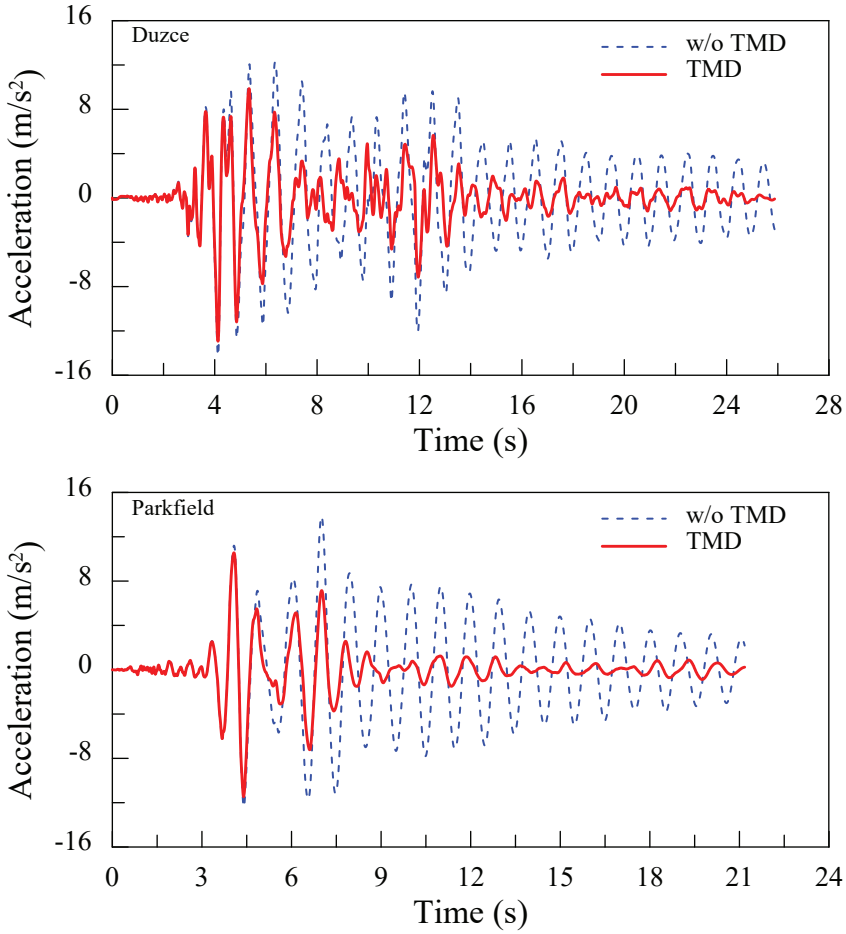




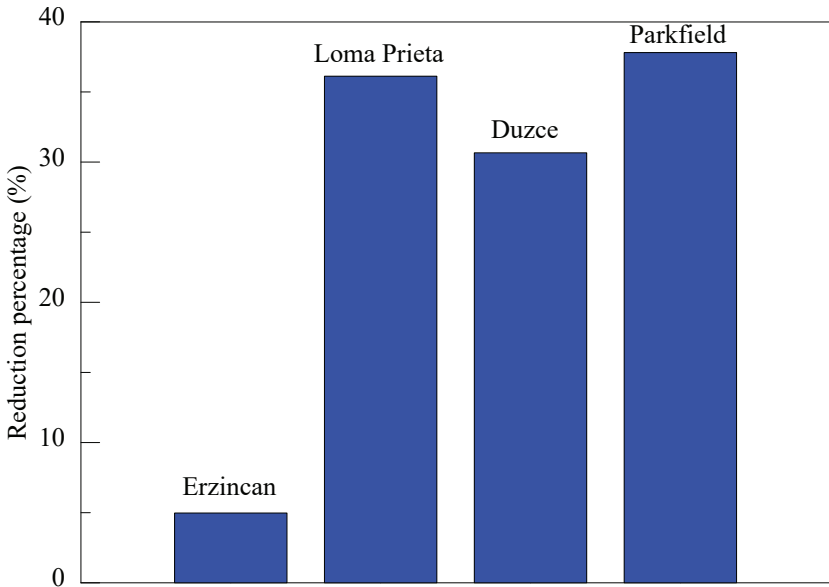


**Fig. 7.** Time histories of the top story displacement.

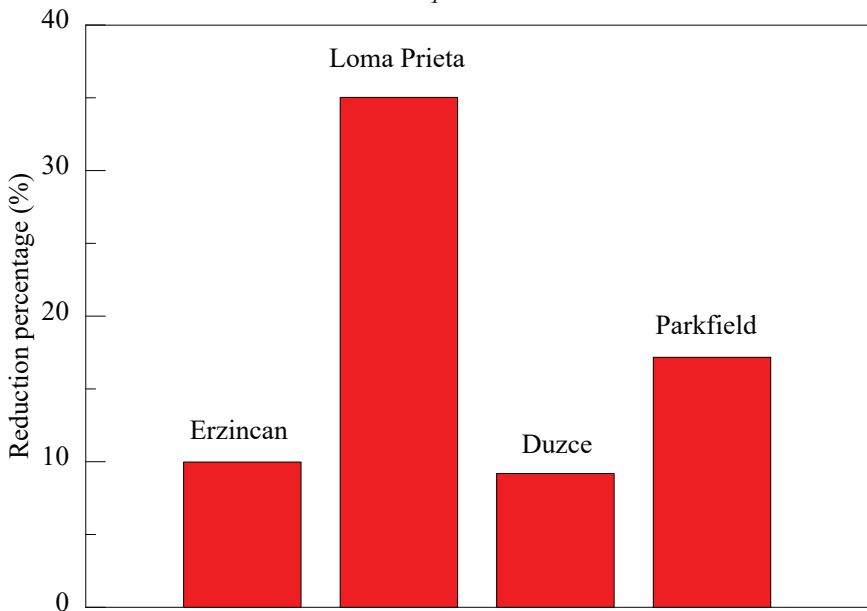




*Fig. 8. Time histories of the top story acceleration.*



**Fig. 9.** Reduction percentage of peak displacement of the building under various earthquakes.



**Fig. 10.** Reduction percentage of peak acceleration of the building under various earthquakes.

The maximum displacements and accelerations of floors under various earthquake excitations are given in Figs. 5 and 6, respectively. These figures indicate that the TMD can reduce the maximum floor responses of the ten-story building.

The displacements and accelerations of top floor of the building due to various earthquake excitations are given in Figs. 7 and 8, respectively. As can be seen, the use of TMD effectively reduces the responses on the top story of a ten-story building.

The reduction percentages obtained in maximum displacement and acceleration responses of 10-story building under different earthquakes are given in Figs. 9 and 10, respectively. As seen in these figures, the frequency content of the earthquake record plays an important role on the effectiveness of TMD. Another observation from these figures is that both the displacement and acceleration responses of the building during the Loma Prieta earthquake are effectively reduced.

## 5 Conclusions

In this work, the influence of various optimization methods on the optimization of TMD is investigated. The control performance of the optimum TMD is verified by using four different ground motions. The main results from the study are summarized below.

- Since the tuning parameters of the TMD are obtained in the frequency domain, the frequency content of the earthquake plays an important role in the effectiveness of the TMD.

- Although all algorithms used in this work show similar performance, SQP and PSA provide faster solution in terms of processing time compared to others.

- Although the optimum frequency ratio is obtained similarly for each method, the damping ratios are obtained differently. This result proves that the frequency ratio is more effective in the effectiveness of TMD.

- It has been observed that TMD is effective in suppressing the structural responses of the building under all earthquake records.

- The largest reduction percentages for maximum displacement and maximum acceleration are 37.81% and 35.03%. However, the average reduction percentage obtained for four earthquake records is 27.40% for displacement and 17.84% for acceleration.

- Since it is aimed to reduce the displacement amplitude at the top floor of the building in order to obtain the optimum parameters, the use of TMD is more effective in reducing displacement reactions than acceleration responses.

## REFERENCES

- Anh, N.D., Nguyen, N. X. & Hoa, L. T. (2013) Design of three-element dynamic vibration absorber for damped linear structures. *J Sound Vib*, 332, 4482-4495.
- Araz, O. & Kahya, V. (2018) Effects of manufacturing type on control performance of multiple tuned mass dampers under harmonic excitation. *J Struct Eng Appl Mech*, 1(3), 117-127.
- Araz, O. (2020) Effect of detuning conditions on the performance of non-traditional tuned mass dampers under external excitation. *Arch Appl Mech*, 90, 523-532.
- Araz, O. & Kahya, V. (2020) Series tuned mass dampers in vibration control of continuous railway bridges. *Struct Eng Mechanics*, 73(2), 133-141.
- Araz, O. & Kahya, V. (2021) Design of series tuned mass dampers for seismic control of structures using simulated annealing algorithm. *Arch Appl Mech*, 91, 4343-4359.
- Araz, O. & Kahya, V. (2022) Optimization of multiple tuned mass dampers for a two-span continuous railway bridge via differential evolution algorithm. *Structures*, 39, 29-38.
- Araz, O., Ozturk, K. F. & Cakir, T. (2022) Effect of different objective functions on control performance of tuned mass damper for a high-rise building considering soil-structure interaction. *Archive of Applied Mechanics*, 92, 1413-1429.
- Bakre, S. V. & Jangid, R. S. (2007) Optimal parameters of tuned mass damper for damped main system. *Struct Control Health*, 14, 448-470.
- Bekdaş, G. & Nigdeli, S. M. (2013) Mass ratio factor for optimum tuned mass damper strategies. *Int J Mech Sci*, 71, 68-84.
- Cetin, H. & Aydin, E. (2019) A new tuned mass damper design method based on transfer functions. *KSCE J Civil Eng*, 23, 4463-4480.
- Daniel, Y., Lavan, O. & Levy, R. (2012) Multiple-tuned mass dampers for multi-modal control of pedestrian bridges. *J Struct Eng-ASCE*, 138, 1173-1178.
- Den Hartog, J. P. (1956) Mechanical vibrations. 3rd ed. New York: Mc Graw-Hill.
- Elias, S. (2018) Seismic energy assessment of buildings with tuned vibration absorbers. *Shock and Vibration*, 2051687.
- Elias, S., Matsagar, V. & Datta, T. K. (2019) Distributed tuned mass dampers for multi-mode control of benchmark building under seismic excitations. *J Earthq Eng*, 23, 1137-1172 .
- Frahm, H. (1911) Device for damping of bodies. U.S. Patent No: 989,958.
- Fu, Q., Jiang B., Wang C. & Zhou, X. (2015) A novel deblocking quantization table for luminance component in baseline jpeg. *Journal of Communications*, 10(8), 629-637.
- Fujino, Y. & Abe, M. (1993) Design formulas for tuned mass dampers based on a

- perturbation technique. *Earthquake Eng Struct Dyn*, 22, 833–854.
- Ghosh, A. & Basu, B. (2007) A closed-form optimal tuning criterion for TMD in damped structures. *Struct Control Health Monit*, 14, 681–692.
- Kahya, V. & Araz, O. (2017) Series tuned mass dampers in train-induced vibration control of railway bridges. *Struct Eng Mechanics*, 61(4), 453–461.
- Kahya, V. & Araz, O. (2020) A simple design method for multiple tuned mass dampers in reduction of excessive vibrations of high-speed railway bridges. *Journal of the Faculty of Engineering and Architecture of Gazi University*, 35(2), 607–618.
- Le, L. M., Ly, H. B., Pham, B. T., Le, V. M., Pham, T. A., Nguyen D. H., Tran X. T. & Le, T. T. (2019) Hybrid artificial intelligence approaches for predicting buckling damage of steel columns under axial compression. *Materials*, 12, 1670.
- Li, C. & Zhu, B. (2006) Estimating double tuned mass dampers for structures under ground acceleration using a novel optimum criterion. *J Sound Vib*, 298, 280–297.
- Liu, M. Y., Chiang, W. L., Hwang, J. H. & Chu, C. R. (2008) Wind-induced vibration of high-rise building with tuned mass damper including soil–structure interaction. *J Wind Eng Ind Aerodyn*, 96, 1092–102.
- Luu, M., Zabel, V. & Könke, C. (2012) An optimization method of multi-resonant response of high-speed train bridges using TMDs. *Finite Elem Anal Des*, 53, 13–23.
- Marano, G. C., Greco, R. & Chiaia, B. (2010) A comparison between different optimization criteria for tuned mass dampers design. *J Sound Vib*, 329, 4880–4890.
- Ormondroyd, J. & Den Hartog, J. P. (1928) The theory of dynamic vibration absorber. *T. ASME*, 50, 9–22.
- Rana, R. & Soong, T. T. (1998) Parametric study and simplified design of tuned mass dampers. *Eng Struct*, 20(3), 193–204.
- Xu, K. & Igusa, T. (1992) Dynamic characteristics of multiple substructures with closely spaced frequencies. *Earthq Eng Struct Dyn*, 21, 1059–1070.
- Wang, J. F., Lin, C.C. & Chen, B. L. (2003) Vibration suppression for high-speed railway bridges using tuned mass dampers. *Int J Solids Struct*, 40, 465–491.



## ***CHAPTER 13***

### **NATURAL LANGUAGE PROCESSING TECHNIQUES**

***Seyma SARIGIL<sup>1</sup>***

***Murat KOKLU<sup>2</sup>***

---

1 Selcuk University, The Graduate School of Natural and Applied Science,  
Computer Engineering, [seyma.sargil@lisansustu.selcuk.edu.tr](mailto:seyma.sargil@lisansustu.selcuk.edu.tr)  
ORCID ID: 0000-0001-7903-0787

2 Murat KOKLU, Selcuk University, Faculty of Technology, Computer Engineering,  
[mkoklu@selcuk.edu.tr](mailto:mkoklu@selcuk.edu.tr)  
ORCID ID: 0000-0002-2737-2360

## 1. INTRODUCTION

Today, each of the written, verbal, visual and mobile data that the information age has brought us has a different importance. So that these data have become even more important than the product itself. For example; while selling a bottle of juice was more valuable in the past, today it is more valuable to determine the profile of the person who will buy a bottle of juice and turn it to a strategy. The common goal of people all over the world is to collect data and extract meaningful information from this data.

There are certain universal methods for processing signal, visual or moving data. The processing of natural language data depends on the morphological and semantic structure of the language. Therefore, the fact that each language has different origins complicates the processing of natural language data. Natural Language Processing (NLP), it is deriving meaning mathematically by getting to the root of natural language input or inputs and producing autonomous systems that can interpret this meaning (Taboada, 2016). It is also used for important works such as natural language processing, sentiment analysis, competition tracking, brand control, risk detection in banking systems, labeling, chat bot services, translation and creating public opinion.

The management of the processing of natural language data, unlike the processing of audio and video data, goes through the stages of segmented word tagging and semantic analysis. The accuracy of an analysis is directly proportional to the size and variety of the data. Since ready-made structures with subject-dependent word data are not available for many languages other than English, these two tasks must be done together for all specific studies.

## 2. NATURAL LANGUAGE PROCESSING

Natural language processing is the science that deals with the mathematical processing of data related to natural languages (such as English, Turkish, Russian) (Cambria & White, 2014). The data can be in text, audio or image format. There are different methods for processing these data according to their types. In addition, it has been developed in systems that work more consistently by accepting multiple types of data as input.

Most NLP methods in many languages are incompatible with other languages due to differences in their structures. However, the methods developed for some operations can work universally across languages, no matter what language.

### 2.1. Linguistics

The expression of emotions aims to explain how we should use language to convey subjectivity in linguistics (Langacker, 2019). When



performing sentiment analysis with NLP, firstly, data preprocessing should be done on the source text. (Kannan, 2014). If the data pre-processing text data is taken from an html page, it is completed by decontamination, punctuation, and sequentially applying a series of technical operations. The data preprocessing step ensures that important words are revealed. (Sun, Luo, & Chen, 2017). Therefore, before the operations to be performed, the words should be divided into speech parts and preprocessing operations should be done on each part in accordance with the semantic structure of the language. After the preprocessing stage, the word vector should be determined depending on the subject and the data. Learning is carried out after the relationships between words are revealed through word vectors.

### 2.1.1. Tokenization

It is used to divide the sentences into words and expressions (Kudo & Richardson, 2018). In this way, dictionary of words is created from the text. It is used to create the input of next NLP steps such as removing punctuation marks, pauses and numeric characters, finding the root of the word, completing words with missing letters.

```
message = """Charlie (Freddie Highmore), is a poor boy who finds it difficult to get along with his family. """
word_tokenize(message)

['Charlie',
 ('(',
 'Freddie',
 'Highmore',
 ')',
 ',',
 ',',
 'is',
 'a',
 'poor',
 'boy',
 'who',
 'finds',
 'it',
 'difficult',
 'to',
 'get',
 'along',
 'with',
 'his',
 'family',
 '.']
```

**Figure 2.1:** *Tokenizer example.*

### 2.1.2. Stop Words

In natural language processing models, it is important to have a lot of data, but it is more important for the success of the model that the words extracted from the texts has information. That's why stop words are used. Stop words are found in almost all sentences. Therefore, stop words form a large part of the whole text. Stop word lists are traditionally extracted by frequency analysis of all words in large text (Hao & Hao, 2008).

Stop Words contain the least information in natural language processing and classification methods. (Hao & Hao, 2008). Therefore, stop words are defined as noisy words when performing natural language processing and

should be removed as part of any preprocessing (Ayril & Yavuz, 2011). Some of the stop words in English are: yet, not, who, though, has, only, some, isn't, won, then, should, too, to, few etc.

### 2.1.3. Stemming

Root Detection method is an important feature used in today's NLP word search technologies. Identifying the root of a word is done as the first data preprocessing step in the creation of models developed for classification, categorization and summarization (Jivani, 2011).

Morphological variants of words have similar semantic interpretations. Even if the meaning of a word is the same as its root, since the word form is different, defining each word form with its basic form often plays an important role in getting more accurate results.

```
import nltk
n = nltk.stem.SnowballStemmer('english')
print(n.stem('running'))
print(n.stem('changed'))
print(n.stem('fairly'))
```

```
run
chang
fair
```

**Figure 2.2:** *Stemming example.*

The main idea is to reduce the total number of different terms in a text, which in turn reduces the processing time of the model. As seen in Figure 2.2, “running” changes into “run”, “changed” become “chang”, and “fairly” changes to “fair”.

### 2.1.4. Part-of-speech (POS) tagging

Speech tagging is a NLP process which refers to categorizing words in a sentence in correspondence with a particular part of speech, depending on its context. The division of words into tag groups emerged from the need to use a word for more than one purpose in natural languages.

Taggings are considered a kind of classifier responsible for defining explanations representing semantic information for words in a sentence (Brill, 1992). They decide what words will be included in the data pool. As seen in the example in Table 2.1, each root word is tagged by looking at the type of its form (noun, verb, adjective, etc.).

**Table 2.1:** *Words and their tags for a sample sentence.*

Words	Assigned Tags
I	Pronoun
Want	Verb
An	Determiner
Early	Adjective
Upgrade	Noun
.	Punctuation marks

Previously, by examining the morphological structure of words without considering their meanings, she kept the guesswork of the most likely tag. But today, learning speech fragment tagging methods have emerged (Brill, 1992).

### 2.1.5. Named Entity Recognition (NER)

NER is predicting some terms in a sentence such as team, brand, object, category etc. (Ritter, 2011). NER is known as one of the core tasks of natural language processing. This method first emerged in order to define proper nouns in the texts, and then to associate these names with predefined categories such as person names, institution names, state names according to their relevance (Chinchor, 1997).

### 2.1.6. Lemmatizasyon

Lemmatization is a method derived from the concept of 'lemma', the first word. (Kanis & Skorkoviska, 2010) . This method aims to find the lexical source of words but not the very simplest word root.. This encourages work on lemmatization regardless of the structure of languages (Müller, 2015). The word leaves is a plural word and comes from the root of leaf. Determining the origin of such words is very important for determining the relationships between words (Pliesson, 2004).

## 3. WORD VECTORIZATION

Word vectors are mathematical vectors that represent words according to their specific properties (Grefenstette & Pasi, 1994). The number of values of the vector forms the number of evaluation dimensions of words in the dictionary. For example, a 3-valued word vector represents the distribution of words in the associated dictionary in a 3-dimensional space.

Because word vectors are mathematical, they also allow operations that cannot be done with words normally (Gunawan, Mulyono, & Budiharto, 2018).

For example, an addition operation between two words in word vectors can give a meaningful result in that language (feet + clothing = shoes, airplane – engine = glider).

Each word has a meaning in the sentence it is in. We humans think about the places where the word is used in a sentence in order to get this meaning. When you look at the message list given below, you can see 3 sentences with similar words frequently. Accordingly, the machine learning algorithm that will perform the learning process will not understand the text data. Therefore, they need to be converted into mathematical expressions.

```
import pandas as pd
from sklearn.feature_extraction.text import CountVectorizer #Example BOW vectorize

messages = ['Seyma likes to write code. Elif likes too.',
            'Seyma also likes to play computer games.',
            'Elif does not likes computer games. Elif likes writing.']

vect = CountVectorizer()
vect.fit(messages)

messages_transformed = vect.transform(messages)

print(f'Unique words are: {vect.get_feature_names_out()}')

data = pd.DataFrame(messages_transformed.toarray())

data.columns = vect.get_feature_names_out()

data
```

Unique words are: ['also' 'code' 'computer' 'does' 'elif' 'games' 'likes' 'not' 'play' 'seyma' 'to' 'too' 'write' 'writing']

	also	code	computer	does	elif	games	likes	not	play	seyma	to	too	write	writing
0	0	1	0	0	1	0	2	0	0	1	1	1	1	0
1	1	0	1	0	0	1	1	0	1	1	1	0	0	0
2	0	0	1	1	2	1	2	1	0	0	0	0	0	1

**Figure 3.1:** Skip-gram architecture (Rong, 2014)

The Bag of Word method is given as an example. As seen in Figure 3.1, firstly, independent words are found and it converts the text into a mathematical value by looking at how many times these words are used in the sentence.

### 3.1.1. Word2Vec

Word2Vec is an algorithm for extracting mathematical vectors of words developed by Tomas Mikolov et al. (Mikolov, 2013). It is based on the principle that other words around the target word represent that word. Words size is taken into a certain window and it converts the relationship between neighboring words within the size into numerical values. These numeric values become a matrix with hundreds of dimensions. Each

column specifies a property. Word2Vec, recommended and supported by Google, is not an individual algorithm. It consists of two different learning models (Bag of Word and Skip-gram) (Goldberg, 2014).

### 3.1.1.1. Skip-gram

The Skip-gram algorithm tries to predict the target word data on the edge by looking at the neighboring words in the middle. It is seen that it gives more successful results in small size text (Mikolov, 2013). Skip-gram architecture Figure 3.2. is also seen.

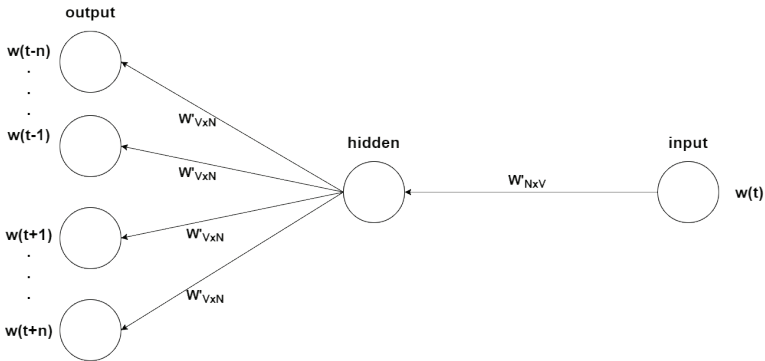


Figure 3.2: Skip-gram architecture (Rong, 2014).

### 3.1.1.2. Continious Bag of Word (CBOW)

The CBOW algorithm tries to predict the target word data in the middle by looking at the neighboring words on the edges. It works faster than skip-gram in model training. Although it is successful in data such as news data consisting of frequently used words, it is seen that it is not successful enough in texts such as tweets in which rare words are used. (Jang, 2019). CBOW architecture Figure 3.3. is also seen. It was created as the reverse of the skip-gram architecture in Figure 3.2.

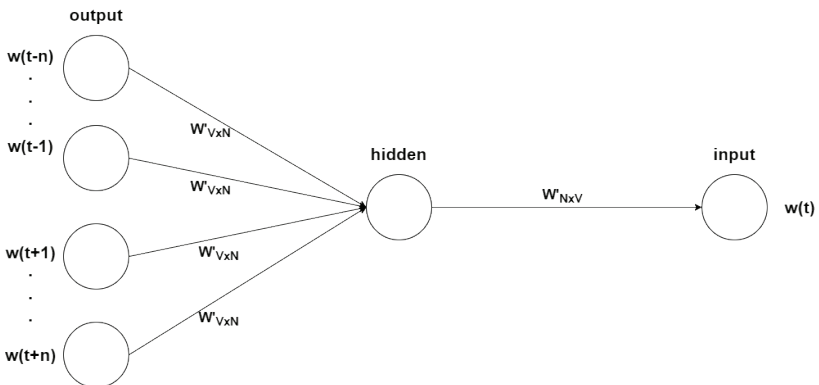


Figure 3.3: CBOW architecture (Rong, 2014).

### 3.1.2. Spherical Text Embedding (GloVe)

The GloVe method factorizes a logarithmic word-context matrix in which the loss function of factorization is weighted. Therefore, errors resulting from frequent associations are penalized more severely than infrequent errors. However, GloVe is trained from non-zero associations and ignores negative examples (zero-valued word-context pairs). This is the difference between training in GloVe and Skip-gram models.

$$J = \sum_{i,j=1}^v f(X_{i,j})(w_i^T w_j + b_i + b_j - \log \log X_{i,j})^2$$

**Equation 3.1:** *Frequency of coexistence of  $W_i W_j$  words in the word-context matrix (Penington, 2014).*

In Equation 1, the frequency of the coexistence of  $W_i W_j$  words in the  $W_{i,j}$  word-context matrix is shown.  $b_i$  and  $b_j$  are considered the amount of deviation from the word vectors  $W_i$  and  $W_j$  respectively, in the model. In this way, adding synthetic words next to subjective words makes it possible to distinguish between word vectors with opposing emotions. (Penington, 2014).

### 3.1.3. Bert

Devlin et al. In 2018, they introduced BERT, which means deep bidirectional transformers, for the first time (Devlin, 2018). Bert creates a tree by converting words to subwords. Also known as the masked language model, its bidirectionality ensures that both right and left contexts are taken into account simultaneously for all layers. (Wiedemann, 2019). Therefore, the upper layers in the same sentence can have a different meaning from each other. The success of the model is extraordinarily successful compared to static word vector algorithms (Ethayarajh, 2019).

### 3.1.4. Generative Pre-trained Transformer 3 (GPT-3)

GPT-3 is a linear stationary random prediction model, the third version of GPT that uses deep learning to generate texts that are as close to human logic as possible. The first version of GPT had 110 million learning parameters while GPT-2 had 1.5 billion learning parameters (Radford & Sutskever, 2019). Today, 175 billion parameters are used in GPT-3 as a feature superior to all other models (Floridi & Chiriatti, 2020). Training of GPT-3 was completed in 34 days using 10,000 V100 GPUs acquired by Microsoft (Brown, 2020). GPT-3 performs powerfully on a variety of tasks such as question-answer, sentiment analysis, decoding, translate, and the use of a new word in a text. For all tasks, GPT-3 is implemented with few step-by-step demonstrations specified via text interaction with the model, without any gradient updates or tweaks (Brown, 2020).

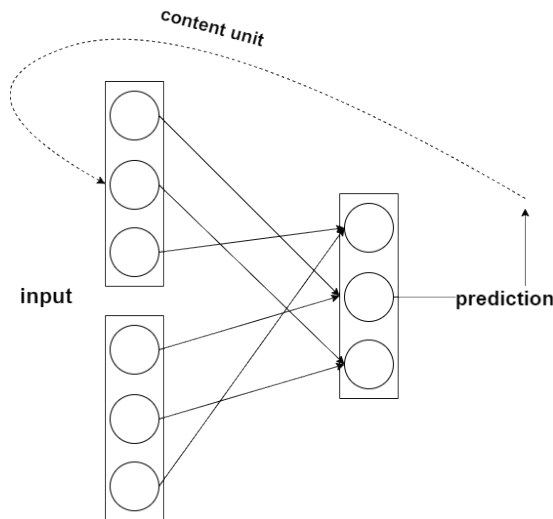
#### 4. RECURRENT NEURAL NETWORK (RNN)

RNN is a specialized deep neural network sub architecture for processing or classifying stringed data. The result, which is different from classical neural networks, feeds the next step.

$$h_t = f(h_{t-1}, X_t)$$

**Equation 4.1:** Back propagation maths (Cho, 2014)

As seen in Equation 4.1.  $h_t$ : represents the current value,  $h_{t-1}$  represents the previous value and  $X_t$ : represents the current input vector. Since the function always includes the previous value, there is no case of forgetting the inputs.

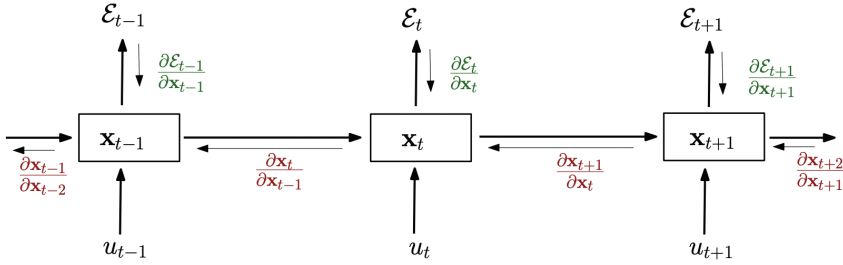


**Figure 4.1:** RNN Process Cycle

The processing cycles of RNNs are realized by taking the prediction output of the outputs and transmitting the content unit as input again, as seen in Figure 4.1. It shows a similar structure in principle to recursive functions. It is not preferred for very deep neural networks because it is a process that remains in itself (Visin, 2015). The problem of decreasing the error effect, which causes it not to be preferred, is called the gradient vanishing problem (Li, 2018).

##### 4.1. The Gradient Vanishing Problem

As information moves from input neurons to output neurons along the neural network, it updates its weights according to the error and performs backpropagation. Weights randomly assigned to close to zero fall below zero over time with repeated weight updates to reduce the error. This problem is called gradient vanishing problem (Hochreiter, 1998).

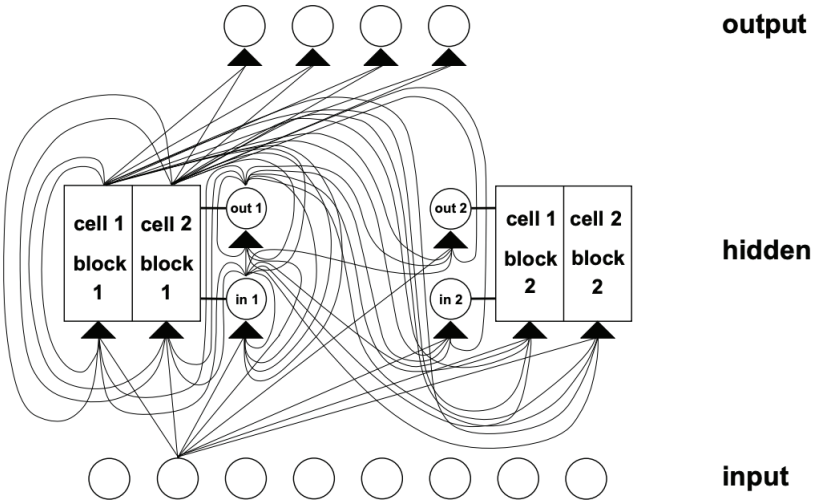


**Figure 4.2.:** For each epoch, the hidden state of the network at time  $x_t$  and  $t$  the input at time  $t$  with  $U_t$  and the error obtained from the output at time  $\epsilon_t$  and time  $t$  (Pascanu & Bengio, 2013).

As can be seen in Figure 4.2. For example, to get from  $x_{t-3}$  to  $x_{t-2}$  we multiply  $x_{t-3}$  by the repeated weight. Then we multiply  $x_{t-2}$  again by the intermediate output to get from  $x_{t-2}$  to  $x_{t-1}$ . As you can see, when we multiply the number by a small number, the value decreases logarithmically.

### 4.2. Long Short-Term Memory (LSTM)

LSTM, was developed in 1997 as a solution to the gradient vanishing problem (Hochreiter & Schmidhuber, 1997). LSTM consists of a sequential structure one after the other. It basically has 3 layers.



**Figure 4.3:** LSTM Architecture layers (Hochreiter & Schmidhuber, 1997)

The Forget gate uses sigmoid as the activation function and is the layer that decides what information should or should not be forgotten. The input gate decides the candidates that will create the new information using the  $\tanh$  function. The output gate is the layer that decides what information will be output or not. In the cell state layer, information transfer is provided (Sherstinsky, 2020).



## REFERENCES

- Ayral, H., & Yavuz, S. (2011). An Automated Domain Specific Stop Word Generation Method for Natural Language Text Classification. *Innovations in Intelligent Systems and Applications (INISTA) 2011 International Symposium*, 500-503.
- Brill, E. (1992). A simple rule-based part of speech tagger. *Third Conference on Applied Natural Language Processing* (s. 152–155). Trento, Italy: Association for Computational Linguistics.
- Brown, T. B. (2020). Language models are few-shot learners. *arXiv preprint arXiv*, 2005.14165.
- Cambria, E., & White, B. (2014). A review of natural language processing research. IEEE Computational intelligence magazine. *Jumping NLP curves*, 9.2: 48-57.
- Chinchor, N. R. (1997). MUC-7 named entity task definition. *In Proceedings of the 7th Conference on Message Understanding*, (s. 29: 1-21).
- Cho, K. e. (2014). Learning phrase representations using RNN encoder-decoder for statistical machine translation. . *arXiv preprint arXiv*, 1406-1078.
- Devlin, J. e. (2018). Bert: Pre-training of deep bidirectional transformers for language understanding. . *arXiv preprint arXiv*, 1810.04805.
- Ethayarajh, K. (2019). How contextual are contextualized word representations? comparing the geometry of BERT, ELMo, and GPT-2 embeddings. *arXiv preprint arXiv*, 1909.00512.
- Floridi, L., & Chiriatti, M. (2020). GPT-3: Its Nature, Scope, Limits, and Consequences. *Minds and Machines*, 30:681–694.
- Goldberg, Y. (2014). word2vec Explained: deriving Mikolov et al.'s negative-sampling word-embedding method. *arXiv preprint arXiv*, 1402.3722.
- Grefenstette, G., & Pasi, T. (1994). What is a word, what is a sentence? *problems of Tokenisation*.
- Gunawan, A. A., Mulyono, P. R., & Budiharto, W. (2018). Indonesian question answering system for solving arithmetic word problems on intelligent humanoid robot. . *Procedia Computer Science*, 135: 719-726.
- Hao, L., & Hao, L. (2008). Automatic Identification of Stop Words in Chinese Text Classification. *International Conference on Computer Science and Software Engineering*, 718-722.
- Hochreiter, S., & Schmidhuber, J. (1997). Long short-term memory. *Neural computation*, 9.8: 1735-1780.
- Hochreiter, S. (1998). The vanishing gradient problem during learning recurrent neural nets and problem solutions. *International Journal of Uncertainty, Fuzziness and Knowledge-Based Systems*, 6.02: 107-116.

- Jang, B. K. (2019). Word2vec convolutional neural networks for classification of news articles and tweets. *PLoS one.*, 14(8), e0220976.
- Jivani, A. G. (2011). A comparative study of stemming algorithms. *Int. J. Comp. Tech. Appl.*, 2(6), 1930-1938.
- Kanis, J., & Skorkoviska, L. (2010). Comparison of different lemmatization approaches through the means of information retrieval performance. *International Conference on Text, Speech and Dialogue* (s. 93-100). Berlin, Heidelberg: Springer.
- Kannan, S. e. (2014). Preprocessing techniques for text mining. *International Journal of Computer Science & Communication Networks*, 5.1: 7-16.
- Kudo, T., & Richardson, J. (2018). Sentencepiece: A simple and language independent subword tokenizer and detokenizer for neural text processing. . *arXiv preprint arXiv*, 1808.06226.
- Langacker, R. W. (2019). Subjectification. *Veredas-Revista de Estudos Linguísticos*, 23(2).
- Li, S. e. (2018). Independently recurrent neural network (indrnn): Building a longer and deeper rnn. In *Proceedings of the IEEE conference on computer vision and pattern recognition.*, 5457-5466.
- Mikolov, T. S. (2013). Distributed representations of words and phrases and their compositionality. *arXiv preprint arXiv*, 1310.4546.
- Müller, T. C. (2015). Joint lemmatization and morphological tagging with lemming. In *Proceedings of the 2015 Conference on Empirical Methods in Natural Language Processing*, 2268-2274.
- Pascanu, R. M., & Bengio, Y. (2013). On the difficulty of training recurrent neural networks. *Proceedings of the 30th International Conference on Machine Learning*, in *Proceedings of Machine Learning Research*, 28(3):1310-1318.
- Pennington, J. S. (2014). GloVe: Global Vectors for Word Representation. *Proceedings of the 2014 Conference on Empirical Methods in Natural Language Processing (EMNLP)*, 1532-1543.
- Plisson, J. e. (2004). A rule based approach to word lemmatization. In: *Proceedings of IS.*, 83-86.
- Radford, A. W., & Sutskever, I. (2019). Language models are unsupervised multi-task learners. *OpenAI blog*, 1(8), 9.
- Ritter, A. C. (2011). Named entity recognition in tweets: an experimental study. In *Proceedings of the 2011 conference on empirical methods in natural language processing*, (s. 1524-1534).
- Rong, X. (2014). word2vec parameter learning explained. *arXiv preprint arXiv*, 1411-2738.
- Sherstinsky, A. (2020). Fundamentals of recurrent neural network (RNN) and long

short-term memory (LSTM) network. *Physica D: Nonlinear Phenomena*, 404: 132306.

Sun, S., Luo, C., & Chen, J. (2017). A review of natural language processing techniques for opinion mining systems. *Information fusion*, 36: 10-25.

Taboada, M. (2016). Sentiment Analysis: An Overview from Linguistics. *Annu. Rev. Linguist*, 2:325-347.

Visin, F. e. (2015). Renet: A recurrent neural network based alternative to convolutional networks. *arXiv preprint arXiv*, 1505.00393.

Wiedemann, G. e. (2019). Does BERT make any sense? Interpretable word sense disambiguation with contextualized embeddings. *arXiv preprint arXiv*, 1909.10430.





## **CHAPTER 14**

### **PACKAGING DEMAND FORECAST IN LOGISTICS USING CNN AND LSTM MODELS**

*Yashwanth BACHU<sup>1</sup>*

*Mehmet KARABULUT<sup>2</sup>*

*Huseyin KUSETOGULLARI<sup>3</sup>*

---

1 Blekinge Institute of Technology, Faculty of Computing, Karlskrona, Sweden

2 Asst. Prof. Dr., Yozgat Bozok University, Department of Computer Engineering, Yozgat, Turkey

3 Asst. Prof. Dr., Blekinge Institute of Technology, Department of Computer Science, Karlskrona, Sweden

baya17@student.bth.se, mehmet.karabulut@bozok.edu.tr, huseyin.kusetogullari@bth.se  
corresponding author: mehmet.karabulut@bozok.edu.tr, ORCID ID: 0000-0001-6410-4835

## INTRODUCTION

Logistics are part of Supply Chain Management. Logistics manages the flow of goods, beginning from materials supply from suppliers to manufacturing and ending with the product's delivery to the end-user (Hugos 2018). Packaging Management is the team responsible for providing the packaging material for suppliers to pack the parts and material for manufacturing. It is also responsible for providing the packaging material to the manufacturing unit to pack the finished products.

Volvo Group comprises several truck manufacturing companies like Volvo, Renault, UD Trucks, and MACK Trucks (Volvo - Wikipedia, 2022). In addition, Volvo group is home to Volvo Penta, Construction Equipment, and several bus manufacturers (Volvo - Wikipedia, 2022). Volvo has standard design and packaging material for the entire supply chain of all Volvo group associates (Volvo Group Packaging System, 2019). Packaging materials are used from the supplier of materials until the delivery to customers. Volvo Packaging or V-EMB refers to the branch of Volvo organization responsible for Packaging materials (Volvo Group Packaging System, 2019). In this study, hereafter, Organization or Volvo refers to Volvo Packaging.

Ensuring the availability of packaging material is extremely important and a Key Performance Indicator for Volvo Packaging Management. It will be similar to any supply chain management that cares about the safety of material transported. On the other hand, having more than the required packaging material is a serious issue of investment loss. Balancing this can be achieved through reliable forecasting and planning ahead of excessive and low demands. Though Supply Chain Management needs to meet customer needs and demand, it is not the only influencing factor for internal demands like the packaging. This is well understood from the Essentials of Supply Chain Management by Michael Hugos (Hugos, 2018). That is why regular sales forecasting and demand can't be simply used for Packaging Demand (PD), and there is a need for forecasting at the packaging level.

The packaging demand depends on several factors like space optimization techniques, manufacturing policies with respect to each manufacturing plant, packaging norms of the company dependent on the nation to be shipped, and fragility of the material. Considering the influence of these factors, it is not easy to get accurate forecasting of the packaging demand with statistical forecasting methods.

Statistical forecasting models (Box and others, 2015) like Moving Average (MA) (Winters, 1960), Autoregressive (AR) (Winters, 1960), Autoregressive Moving Average (ARMA) (Box and others, 2015), and Autoregressive Integrated Moving Average (ARIMA) (Gilbert, 2005) have been widely used in various fields of forecasting. In another study (Vineeth, and others, 2020), forecasting the sales model using machine learning, a sub-branch of artificial intelligence, was examined. However, Neural Networks have outperformed other forecasting methods, especially with time-series data

in the supply chain (Carbonneau and others, 2008). Therefore, this study finds suitable Deep Neural Networks (DNN) for forecasting packaging demand considering the above factors and finding the method for long-term forecasting. The demand for packaging can be recorded based on the instance of time. Therefore it's expected to predict the future packaging demand for the time instance. The research is motivated to forecast for the coming year, which is 52 weeks of forecasting into the future. The length of the time stamp is long, and it is considered long-term forecasting.

Any operation associated with the business directly or indirectly influences market demand because the purpose of business is to address market needs. Market demand has many influencing factors like economy, political stability, and natural disasters. In this problem, we have volumes of vehicle production influenced by those factors. Volvo has an internal organization with hundreds of data scientists considering those factors at the dealer level. They plan the production volume for the coming year from their learnings. Considering those planned vehicle production volumes will help the model learn their impact on future packaging demand.

Apart from developing an effective forecasting model, certain things must be considered before implementing them in practice. This may include companies' maturity and understanding of the requirements. This was discussed with respect to spare parts management in (Bacchetti and Saccani, 2012). As this study is performed and planned to implement in a well-established organization and mature enough to use forecast, one of the essential practice requirements is met. Other practical implementation requirements are also considered and can be tested through pilot runs.

The main aim of this study is to identify a suitable Deep Learning technique to forecast packaging demand using historical time series data. In addition, forecasting must also consider the planned production volume (these volumes are planned from the forecast by sales) at respective time intervals. Therefore, three primary objectives are formulated to achieve the targeted aim (Bachu and Kusetogullari, 2019).

Formulated objectives are as follows:

- Understand the existing deep learning models in forecasting.
- Identifying and modifying the best DNN techniques for packaging demand long-term forecasting.
- Analyzing results and suggesting the best suitable model for the problem.

## **FORECASTING**

Forecasting is a method, which operates historical data as an input to determine the track of future trends. Forecasting can be performed by a simple algorithmic rule. On the other hand, the forecasting model is selected based on the given data. Therefore, the words "forecasting methods" and "forecasting model" don't stand for the same, and they must not be used as

synonyms. Time-series forecasting methods are generalized into three types based on the type of data and available related variables (Chatfield, 2000). Three generalized methods are judgemental forecasts, univariate methods, and multivariate methods.

### **Time Series Forecasting**

A time-series is a collection of observations made sequentially through time (Chatfield, 2000). The most commonly identified time-series data are stock prices. Some other examples of time series are sales of a particular product in a supermarket, the temperature of a particular city at noon every day, and the heat demand of a particular county every month. Based on the frequency at which the data is recorded or observed, time-series is of two types continuous time-series and discrete time-series (Granger and Newbold, 2014). If there are observations at every movement of time, it is considered as continuous time-series (Granger and Newbold, 2014). On the other hand, if the data is recorded at fixed time intervals like daily, hourly, or monthly, it is called as discrete time-series data (Granger and Newbold, 2014).

In a time-series forecast, it is essential to mention both the lead time or forecast time gap and the time at which the forecast has been made. A forecasting method is a procedure for computing forecasts from the present past values by Chris Chatfield (Chatfield, 2000).

### **Long-Term Forecasting**

Time-series can be of three types short-term, medium-term and long-term forecasting. Their name states what difference those types possess. Unfortunately, there is no such standard time stamp that states exactly the range of short, medium, and long-term forecasting models have to predict. It is often referred to as the minute, hour, and weekly forecast considered a short-term forecast. While monthly and quarterly forecasting is considered medium-term, forecasting beyond a year is considered long-term forecasting (Yang and others, 2017; Aneiros and others, 2016). Scott Armstrong stated in his article that “long-range” is the length of time required for all associates of the organization (system) to react to given stimuli (Armstrong, 1985).

In a research (Pelletier and Turcotte, 1997) group of four researchers performed early research on where they were assessing the recurrence interval of droughts based on two different models. This research was not generating the magnitude but the recurrence time interval of occurrence. They have used Autoregression 1 (AR(1)) and Functional Noise (FN) as two models. In their research, they were forecasting values of 100 to 500 years and can be called long-range models quite comfortably. Forecasting website traffic is essential for many websites to ensure website links are ready to meet future traffic (Papagiannaki and others, 2003) Papagiannaki and others carried out one such attempt to forecast of website traffic. They forecasted website traffic demand for around 6 months at a frequency of half-day. As the predictions were at a much granular level 6 months are considered long-term. In this study, the authors have used the ARIMA model for the forecast. They also



implemented the same model at a cycle of the day (24 hours) and weeks along with 12 hours. They achieved a forecasting error of less than 15.

In a journal (Hyndman and Fan, 2010), Hyndman and Shu Fan researched forecasting long-term electricity demand. The forecast was presented in the southern Australia region of the National Electricity Market (NEM). They proposed a methodology to forecast annual and weekly peak electricity demand density for the coming 10 years. They developed a model with three major features and one error feature. Three major features are: calendar effects, temperature effects, and demographic/economic effects. Error feature was to consider the other external effects apart from those three features. The proposed model was split into annual and half-hourly effects being estimated separately. A seasonal bootstrapping method with variable blocks is performed to simulate temperature accordingly. The results confirm that the model performs well on the historical data.

### **Deep Neural Network in Forecasting**

Many real-world problems need much more accurate forecasting than statistical models, and the need for more accurate forecastings is increasing daily. Forecasting was started around the mid-19th century. The oldest article used in this study was from 1994, using machine learning methods (Connor and others, 1994). Deep Neural Network (DNN) is a sophisticated Artificial Neural Network (ANN). DNN and ANN are a sub-part of machine learning methods. DNN contributes to many fields, especially forecasting. DNN is scoring the best performances, observed from the following learnings.

LSTM is implemented by Wei Bao and others in their research (Bao and others, 2017). They implemented stacked autoencoders (SAE) to extract deep daily features. Their study forecasted the closing stock price of six popular stock indices one-step-ahead. They tested LSTM performance with three state-of-art-methods with predictive accuracy and profitability. The proposed model of the study was proven to outperform the three others in predictive accuracy and profitability (Bao and others, 2017).

In another research last year conducted by Anastasia and two others (Borovykh, 2017), they proposed a method for time-series forecasting using Deep Convolutional WaveNet architecture. The study was performed over exchange rate data of five different currencies. The data was a multivariate time-series data. The study compared Convolutional WaveNet (cWN), Vector Autoregressive (VAR), and LSTM models. The study observed that VAR and cWN performing were better than LSTM, while cWN is the best of the three. They measured performance based on the Mean Standard Deviation of the forecast. There are some hybrid models used in DNN for forecasting. Some researchers find that an ensemble of best models results in more accurate forecasts than one best model. However, this wouldn't apply to all problems. In a research (Qiu, 2014), it is performed by a group of four in Singapore proposed a model of ensemble using Deep Belief Network (DBN) and Support Vector Regression (SVR). They compared it with DBN, SVR,

Feed Forward Neural Network (FNN), and Ensemble Feed Forward Neural Network (ENN). Though the margin is very low, the proposed model in the research performed better than other models (Qiu, 2014).

In search of better-performing hybrid models, John Gamboa conducted a study. His article “Deep Learning for Time-Series Analysis” (Gamboa, 2017) reviewed several models and concluded that stacking several independent layers would yield better results.

### **Problem Domain**

Packaging is essential in logistic services, which protects the parts from damage. Packaging through standardized designs and sizes will make the handling and shipping of parts and goods easy. There is a need for sophisticated forecasting to meet the demands of packaging,

The packaging demand is influenced by several factors like production demand, packaging inventory with production, lead time, policy change in packaging, innovation in packaging designs, and new packaging types for special packaging. Volvo Logistics AB requires 52 weeks (1 week = 1 data point) of packaging demand forecasting. This requirement helps them in the decision-making of the procurement of packaging for the upcoming year. Packaging demand would help them re-positioning packaging material to meet demand at their different terminals. The annual purchase of packaging materials is high-priced, and the organization would like to optimize their expenses by accurate forecasting.

### **Adapted Approaches**

Some DNN models were selected for the study in the initial days of research. The study’s supervisors guided the selection by considering the data structure and correlating the data. The study aimed to forecast long-term packaging demand, which is a multi-step ahead forecasting. Therefore, selecting a suitable strategy was important in the study and it was selected from the learnings mentioned in the previous section (Bachu and Kusetogullari, 2019).

### **Mimo**

After analyzing the five strategies widely used for multi-step-ahead forecasting, Multi-Input Multi-Output (MIMO) is considered best suited for the problem. Though DIRMO (MISMO) is a more advanced strategy for balancing stochasticity and variable dependencies, the time-series data associated with this problem is found with solid correlations with its variables. Thus MIMO strategy is considered for long-term forecasting of packaging demand.

### **DNN Models**

Using Machine Learning, there are many models and methods to do forecasting. From a detailed analysis of the forecasting using Deep Neural Network (DNN) models, two DNNs are found to be performing with the best results. LSTM and CNN are the two DNN models performing well

in long-term time-series forecasting (Bachu and Kusetogullari, 2019). The models are implemented with the MIMO strategy.

## **METHODOLOGY**

Merits of CNN and LSTM models and their causes of better performance for that particular problem are identified. Production volumes of the future are also input features to the models. Two models were suitable for forecasting packaging demand using historical time-series data and predicted production demand is selected. Selection of performance measures was carried out to evaluate time-series forecasting models.

An experiment was performed to evaluate the selected DNN models for forecasting. The experiment is performed in a controlled environment. Two DNN models are implemented with the MIMO strategy and evaluated by three selected performance measures. The models are trained with the sliding window procedure. The division of training samples and testing samples are divided with data availability and considering the use case of the organization. As the organization is exploring to identify the demand for next 52 weeks, so 52 steps ahead forecasting is performed and a validation set of sizes 5 and 1 was considered. The validation set of size 4 has each sample with a horizon of 52, but five samples are starting with lagging 1 time-step, immediate time-step, one time-step ahead, two time-steps, and three time-steps ahead, respectively. The first validation set gives how robust the model is in predicting time gaps. The second validation set helps in identifying the model suited for the problem.

The experiment phase starts from the collection of data and continues with preprocessing data, structuring/reshaping data, setting up an experiment, developing models, and concludes with a collection of observations and performance (Bachu and Kusetogullari, 2019). Actions and steps performed during those phases are described in the following sections.

### **Data Gathering**

Data collection is one of the challenging stages in a study. Data can be collected through applications such as SAP or automatically via electronic cards. Data collection via electronic cards was studied in (Karabulut and others, 2020). However, this study focused on data stored via SAP. The organization (Volvo) has many stakeholders over the data recorded in SAP application and the data is available for only the last 6 months in the system. After reaching out to every high-level stakeholder, the system finally got its hands on the actual data. Data was in the archive but well established on the local database by an analyst. The data captured by the system was transactions of packaging materials. Those transactions were included between each node of the entire supply chain system.

The study of features and the key nodes of the supply chain are identified and selected from 6 months data, to pull only value-adding data. Then with specific parameters, transactions of the selected leg in the supply chain

(Hugos, 2018) are pulled out for research. A leg is generally referred to as a small portion of a supply chain in the logistics industry. A leg has an origin, carrier, and destination. It was observed that the same packaging material was recorded in several transactions in one cycle of the entire supply chain. That is because packaging material sometimes moves from pool to supplier, supplier to second-tier supplier. There are cases where more than two suppliers would transit the material before it reaches the factory. Some portion is sent back to the pool from the factory for reuse, while the rest are sent to customers or dealers. That means one packaging has been recorded on several legs in the supply chain. From the analysis of six months' data, it is observed that the total packaging transactions are recorded at the inflow of the factory i.e., transactions with materials received by the factory are the leg, where the least duplicates and the complete track are identified irrespective of the sender. The transactions are pulled out for research from that particular leg.

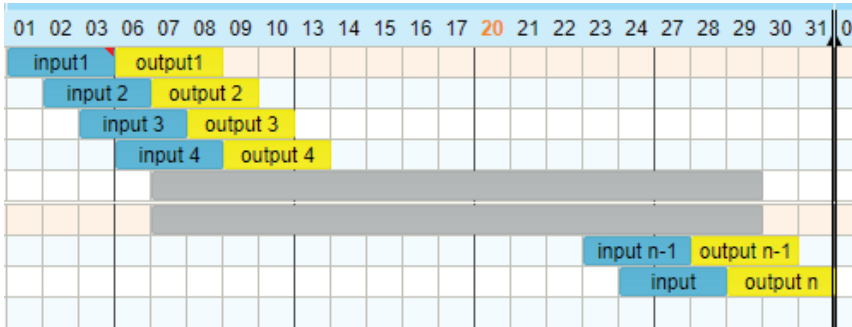
The other data associated with the research was the vehicle production volume at the plant (factory). The productions are the reasons behind the entire supply chain and the demand for packaging materials. The production data is clean and ready to use. The production data has production volumes at a factory in the past and future. As mentioned in the introduction, future production volumes are planned vehicle production volumes (Bachu and Kusetogullari, 2019).

### **Data Preprocessing**

Once the packaging data was pulled with the filter, there were very few duplicates of transactions that were dropped as the first step of cleaning the data. However, there were also some empty transactions with null values. Users realized that those transactions are junk generated while transactions ended abruptly while entering the system. So those empty transactions are also dropped. The data remained clean without null, duplicates, and missing values. However, this transactional data is not in the exact shape to feed into the model and needs reshaping. Therefore, the data must combine with the factory's production data before reshaping. Combining those two data, the common dimension was the date of transaction and production volumes of the factory on that date. After combining with the date, data is observed in discrete time-series with the day as the least granular time value.

As it is clear that materials are not used on the same day of shipping for production, likewise, there wasn't any correlation between deviations in production and materials in the data. As many researchers (Gilbert, 2005) suggested, the data was scaled up to weekly data to overcome this problem. Scaling shows that data is continuous and has a linear trend and seasonalities like most continuous time-series data. The final ready data for research is in shape; it has week numbers set to index and other variables from packaging data and production volumes on other columns. As per the adapted strategy, MIMO data was in structure, but the future production volumes are to be inserted as the input feature and need to be sliced into frame size. The future

production volumes are added to data by duplicating production volumes and shifting them up to the input frame size of model 52. Then starting with the first-time step, up to 52 are sliced into the first input sample, and the next 52 steps as the first output sample (Bachu and Kusetogullari, 2019). Thus, slicing continues moving one step forward till the end of data is met (figure 1).



**Figure 1:** *Sliding Window Model With 1 Step Increment*

## Data Set Description

The data set is time-series data, as discussed in the early sections. The data has values recorded from 2015 to the latest till the day of data gathered i.e., the end of February (Bachu and Kusetogullari, 2019). The final processed data set has a total of 217 weeks of data. The data set has 176 variables, 2 of 176 variables are features representing production volumes of medium and heavy trucks production. Similarly, 2 more features represent future volumes (recorded or planned) with a time gap equal to the size of the input frame i.e., the 1<sup>st</sup> week has 53<sup>rd</sup> weeks production volume as future production volumes. The rest 172 represents a different types of materials being used. The data is divided into training and testing data 160 weeks of data is used for training different models. 57 weeks of data were untouched and kept offset for testing.

## Experiment Setup

As the experiment is evaluating the selected DNN models and comparing them with their performances, there needed to be proper care to train the models equally prioritized. Therefore, all the models are implemented with the same strategy. The batch size of training was also fixed the same for all models. To ensure that stopping training by a defined parameter of either epoch or learning rate does not impact the performance. All models are defined with an early stopping with a wait time of 400 epochs (Bachu and Kusetogullari, 2019).

The experiment is performed in an online virtual machine to ensure that each model is provided with equal resources during the entire experiment, both for training and evaluating. The online virtual machine used for this experiment was from Microsoft named Data Science Virtual Machine

(DSVM). The experiment used Keras models for LSTM and CNN. It used TensorFlow in the background for NN operations. Scikit Learn range model is used for normalizing and re-normalizing data. Data is normalized before Neural network operation. Data slicing is performed after normalized data, as discussed in the previous section. Sliced data is fed into the input layer of the experimenting model. Then training or forecasting takes place. In forecasting, forecasted data is re-normalized for practical use, but due to data privacy, it has not been disclosed in this study. Visualizing of the learning and forecast were supported using the matplotlib library. Jupyter notebook and Anaconda were the other tools used.

### **Performance Measures**

Three performance measures selected from the study for evaluating DNN are:

*Root Mean Square Error (RMSE):* RMSE measures the deviation from the actual. The name states all the operations that calculate the rooted mean of the square errors. Differences between individual prediction and actual are squared and summed all together, which is then square rooted and finally divided. Lower the RMSE value better the prediction.

*Mean Absolute Error (MAE):* This measures also calculate the deviation from the actual. In addition, this measure calculates the deviation in the metrics of values forecasted and real. An absolute deviation was considered to avoid the negative and positive deviations affecting the deviation measure.

*Mean Absolute Percentage Error (MAPE):* MAPE is the transformed version of MAE. From the value metrics to a percentile of deviation is the transformation. Therefore, MAPE is easier to compare, which is in percentages.

The experiment was conducted, and the performance measures were recorded (Bachu and Kusetogullari, 2019). DNN evaluating metrics were recorded, and results were presented in terms of three measures; RMSE, MAE, and PE, for each DNN model. Other observations recorded during the experiment are the learning curve, execution time, and the main target of the experiment, forecast values.

## **RESULTS**

### **Learning Curve**

Every model in machine learning learns from the history of data. Similarly, the DNN models used here are trained with history, as mentioned in the previous sections. The model has a learning rate factor that determines to what extent newly acquired information overrides old information. Training of any model is stopped when the learning rate is stable. In this experiment, the early stop method has been implemented to avoid the overfitting of the model. Each model has a learning rate changing from time to time in the training phase, and that line of learning rate is called the learning curve. The learning curve of the two models is plotted in the graphs below. The blue line is the



learning curve of the validation set, and the orange line is the learning curve of the validation set. Figure 2 is the plot of the CNN model learning curves. Figure 3 (a) is the LSTM model learning curves plot until the model is saved by early stop. Figure 3 (b) is the LSTM model learning curves plot illustrating the overfit causing early stop.

### Performance

The models' forecast was analyzed with three measures RMSE, MAE, and PE. Performance measures discussed in the previous section are applied to the forecast of all two models with two variants of each on two different sizes of test samples. Thus, twelve samples are obtained to measure performance. The calculated measures are tabulated into four tables. Table 1 shows the models' performance measures with batch size 2 and test sample size 5. Similarly, table 2 with batch size 2 and test sample size 1. Similarly, table 3 with batch size 32 and test sample size 5. Table 4 with batch size 32 and test sample size 1.

The results are grouped with respect to batch size and test sample size for better analysis of the results (Bachu and Kusetogullari, 2019). Grouping with sample size helps in evaluating models' performance to immediate forecast and forecast with time-gap. Grouping with batch size will enable to understand the impact of batch size on the forecast by models. The results of the measures are discussed in the next section.

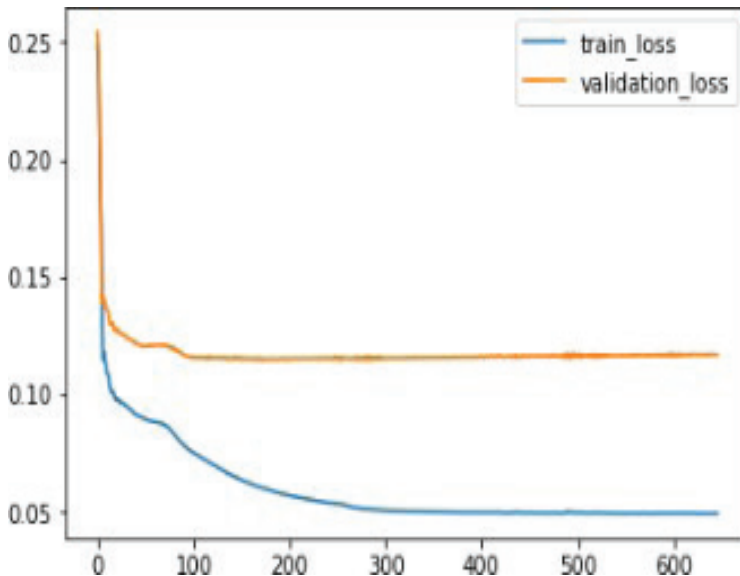


Figure 2: CNN Learning Curves

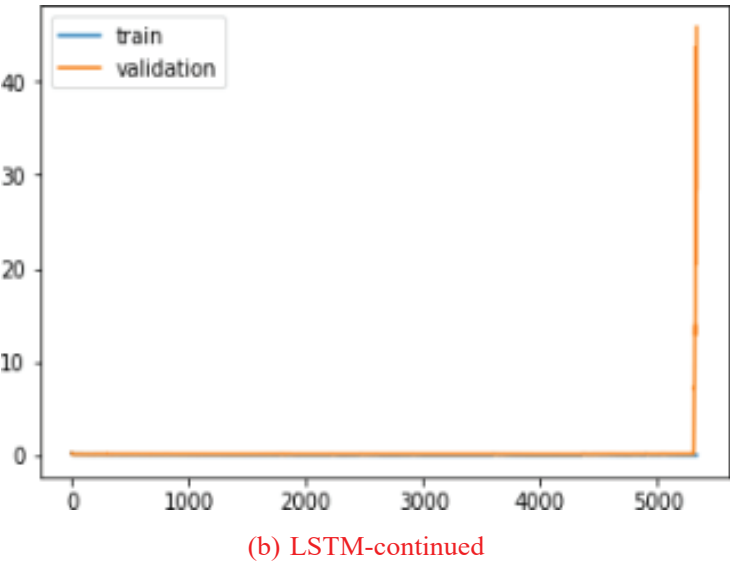
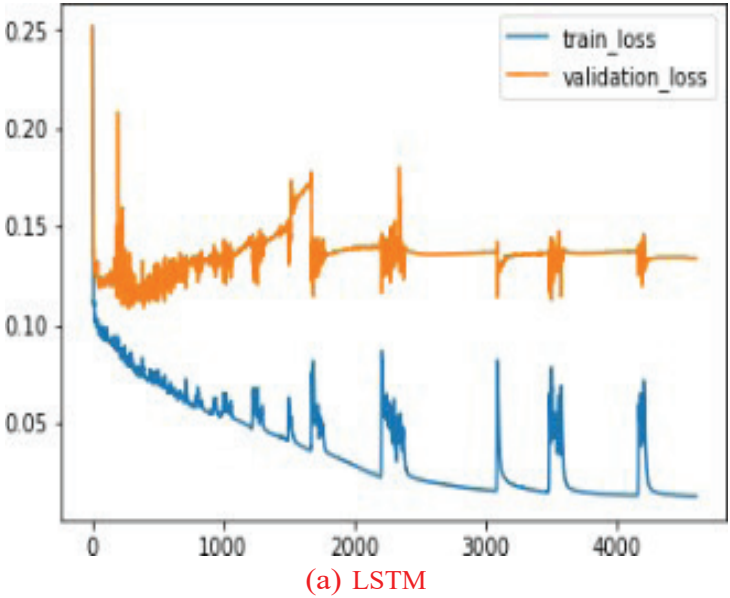


Figure 3: LSTM Learning Curves

### Execution Time

Long-term forecasting is performed for annual planning and strategic planning. Planning will not affect by the execution time of the models as that won't add any value to long-term time-series forecasting. However, as the study is comparing two DNN models and their performance. Comparing their execution times will give insights into the models' performance and execution time. In addition, execution time comparisons help identify merit models with respect to time metrics (Bachu and Kusetogullari, 2019).



This comparison would help select the model for real-time time-series forecasts like real-time trade market, satellites launch, and similar problem areas with the need for real-time forecasting. The execution time of each DNN model with respect to Batch Size (BS) and the number of test samples (SS) are evaluated and recorded in table 5. While the model type is taken to the column, batch size and test sample size are used as an index for easy comparisons. For easy understanding, microseconds are rounded to milliseconds in this comparison.

	RMSE	MAE	PE
LSTM	0.2286808444	0.1407446712255478	14%
CNN	<b>0.1974456079</b>	<b>0.12384917587041855</b>	<b>12%</b>

**Table 1:** Measures of DNN Models While Batch and Test Sample Sizes are 2 and 5

	RMSE	MAE	PE
LSTM	0.225427572	0.14006835222244263	14%
CNN	<b>0.1822909741</b>	<b>0.11193402111530304</b>	<b>11%</b>

**Table 2:** Measures of DNN Models While Batch and Test Sample Sizes are 2 and 1

	RMSE	MAE	PE
LSTM	0.2106728041	0.12695592641830444	13%
CNN	<b>0.1870193082</b>	<b>0.11516165733337402</b>	<b>12%</b>

**Table 3:** Measures of DNN Models While Batch and Test Sample Sizes are 32 and 5

	RMSE	MAE	PE
LSTM	0.1870833078	<b>0.10810592770576477</b>	<b>11%</b>
CNN	<b>0.1835637372</b>	0.112208202481269845	<b>11%</b>

**Table 4:** Measures of DNN Models While Batch and Test Sample Sizes are 32 and 1.

Model	CNN	LSTM
BS = 2 SS = 5	11ms/step	66ms/step
BS = 32 SS = 5	10ms/step	62ms/step
BS = 2 SS = 1	4ms/step	16ms/step
BS = 32 SS = 1	4ms/step	15ms/step

**Table 5:** Execution Time of Each DNN Model

## Forecasting Results

Performance measures are to evaluate the models in terms of their forecasting biases. Therefore, understanding the nature of forecasting visualization is mandatory. By visualizing, we can identify the mimicking ability of historical trends and seasonality. Then, the models generate

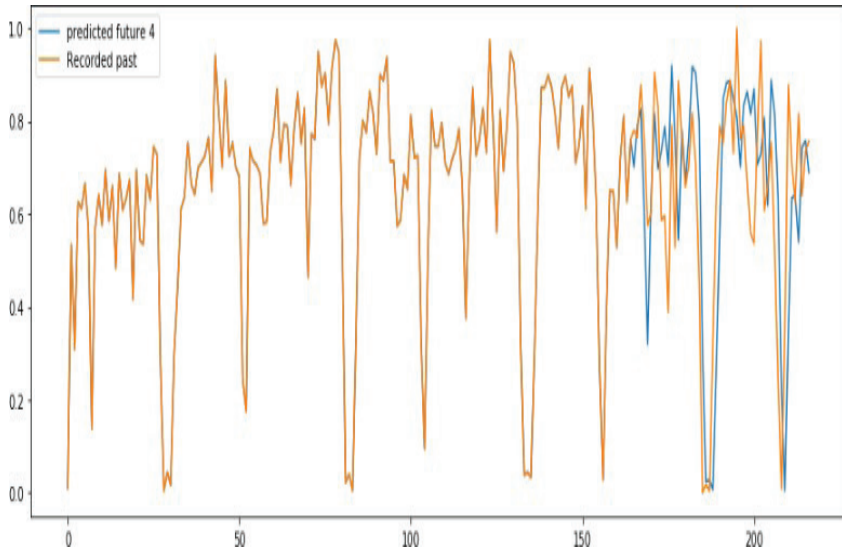
the forecast values, and those values are plotted onto graphs for a better understanding.

The graphs are plotted with forecasts vs. actual values on the time taken as x-coordinate and the normalized volumes of demand on the y-axis from the history for the 165 weeks (3 years) and forecasted demand for the 52 weeks (following one year). Each model has two variants with two different batch sizes. From the early description, the organization has a total of 172 materials, and picturing all of them is not necessary to understand the nature of the models. One material type is selected that is most commonly used and needs planning to procure more actively (Bachu and Kusetogullari, 2019).

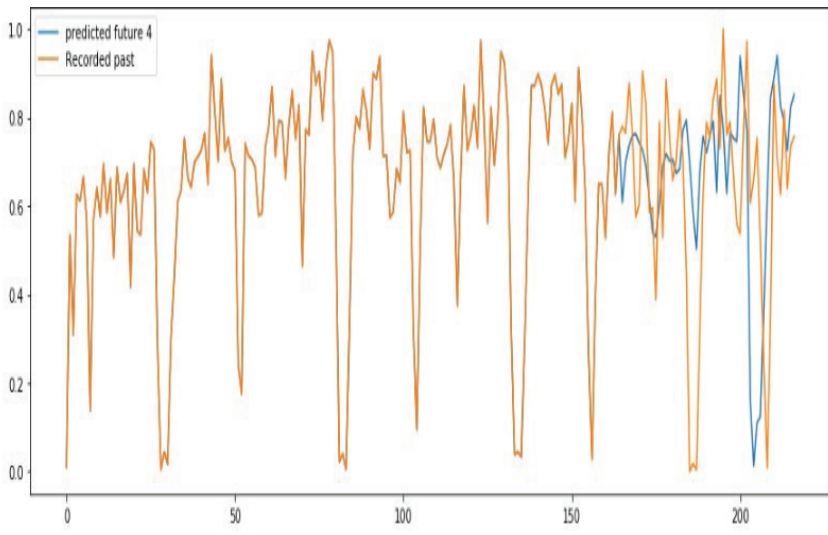
The material chosen for analysis has been plotted. A total of six graphs were plotted with two variants for each model. Plotting graphs would help identify each model's merits and demerits by comparing them. For example, figure 4 has two plots from LSTM model forecasts with two different batch sizes. Similarly, figure 5 is from CNN. The graphs have two color codes representing their source. Orange represents the volumes recorded in history, while blue is predicted. For example, 165 weeks of data were used for training, the last 52 weeks are new data (tested data) for the model, and the blue line is predicted values for those 52 weeks.

### **Deviations**

As there are 172, all of them didn't achieve acceptable forecasts. The reason for those deviations is solid and valid. Bad forecasting could include not selecting proper features, corrupted training data, wrong models, and external (unrelatable) factors. The reason for the deviation of the forecast of a particular material is discussed in the analysis. First, deviating materials are identified with individual forecast measures of each material. Then, the forecast deviation on a particular material is plotted from two models. Figure 6 shows the deviated graph on the same packaging by CNN and LSTM models. These graphs also follow the same color code used in figures 4, and 5.

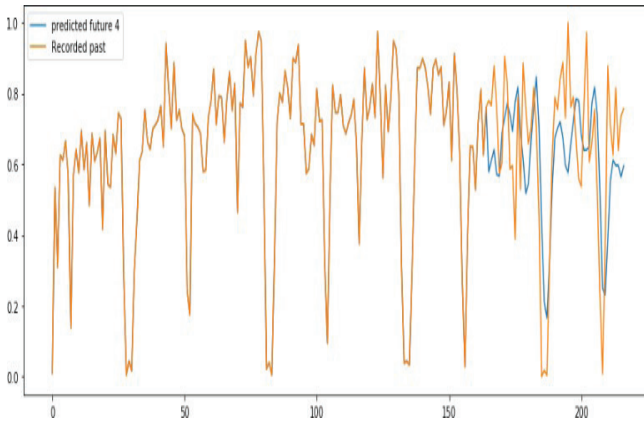


(a) Batch Size-32

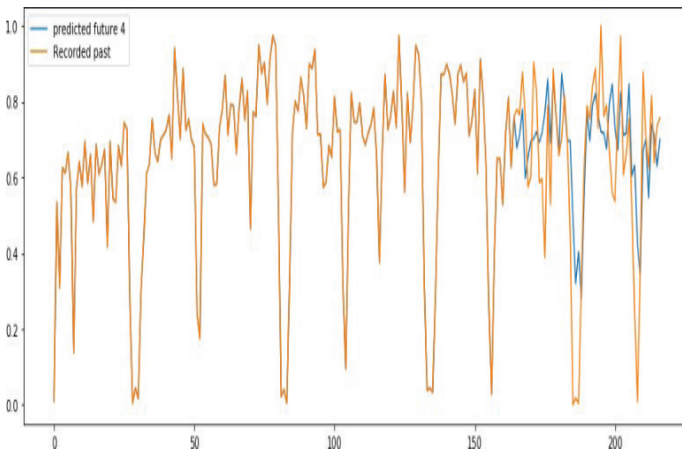


(b) Batch Size-2

**Figure 4:** Forecast by LSTM Models



(a) Batch Size-32



(b) Batch Size-2

**Figure 5:** Forecast by CNN Models

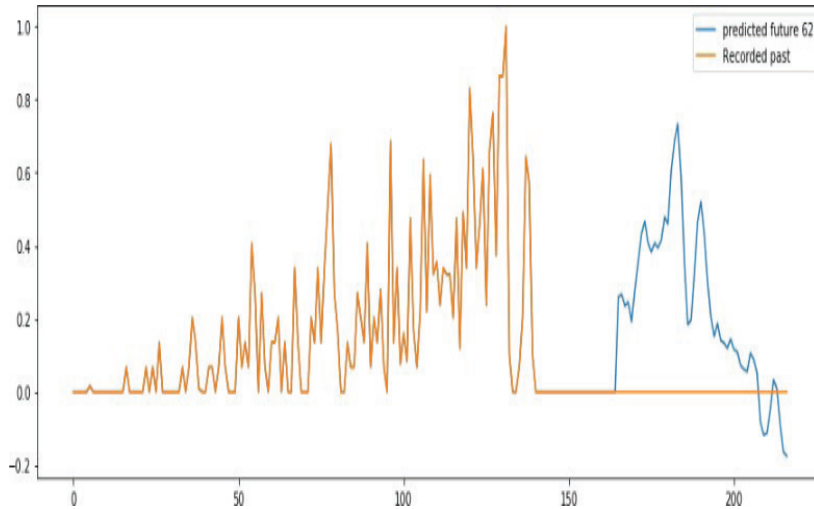
## DISCUSSION

This section is about the analysis of observations that have been recorded and calculated in the previous section results. Analysis and discussion are about understanding and drawing inferences from those observations and results.

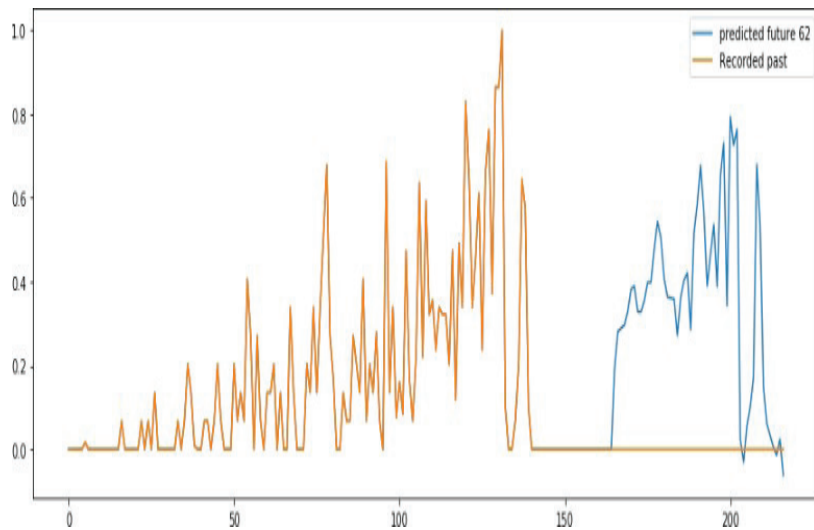
### Forecasting Performance

It is observed from the results that all DNN models are able to forecast long-term time-series data successfully. However, it has been noticed that there are some differences between each model and the variant compared with their performances. The CNN model has excellent forecast performance considering batch sizes as the filtering agent. From tables 1 and 2, CNN performs better with low root mean square error, mean absolute error, and percentage error for the lower batch size variants. But in the case of the larger batch size, the results are not so clear. From tables 3 and 4, the CNN model

has shown better RMSE values than LSTM. However, LSTM has a better MAE in table 4. CNN has leading results in all measures for batch size 32 and test sample size 5. The reason LSTM has the better MAE, even with higher RMSE, would be because of the considerable difference in few forecasts. Those differences in summing up lead to more RMSE but not with the mean of absolute error (Bachu and Kusetogullari, 2019).



(a) CNN



(b) LSTM

**Figure 6:** Deviation in CNN and LSTM Forecast

Now with the test sample size as the distinguishing factor of models, the CNN model has shown better performance for smaller test sample sizes learning from tables 1, 2, 3, and 5. These metrics show that CNN performs better than LSTM for long-term forecasting on time-series data. But looking

at forecasting plots, it is clear that LSTM has good forecasts in identifying the low and high (peak) values even for a small period. The graph clearly shows the reason for its low results in performance with the small batch size because of the lag in forecasts. The lag in the forecast might be due to the influence of its previous states. The reason stated here can be supported by its outperformance with higher batch size training and small test sample size forecast. The small test sample size is the forecast for the immediate next 52 weeks from the input of the before 52 weeks. Seasonality plays a significant role here. The test sample size of 5 is not the same case. That is why LSTM couldn't perform well (Bachu and Kusetogullari, 2019).

A few variables of the entire time-series representing specific packaging material types have been kept on a halt from usage due to policy changes. One such case is represented in figure 6, where deviation was observed in two models. As policy changes and environmental reforms are external factors impacting demand, it is not expected to learn from the model. It will not be quick for a model to understand and reflect such changes in the forecast. As the long-term forecast is for planning far ahead and the organization (Volvo) is ready with a track of such material types. Knowledge of such impacts is expected from any group interested in long-term forecasting, and it must be for practical use of forecast. Negative values in figure 6 are due to scale, '0' in the graph is not ground zero.

### **Execution Time**

As mentioned before, based on the problem domain, this study is not taking any inference or recommendation to select the DNN model based on its execution time. But this could be a reference for the other researchers on real-time time-series analysis. It is visible that LSTM is taking more time than CNN. The time consumed for the test sample size of 5 is more than that of one because of repetitively doing the procedure five times, but the time consumed is not 5 times to that of test sample size 1. The LSTM is RNN and has several memory operations and recursive connections in its neural network, making it more time-consuming than other neural networks. CNN feedforward network makes less complex, resulting in low execution time (Bachu and Kusetogullari, 2019).

### **Limitations of the research**

Several elements are possible limiting agents of the forecasting performance presented in this study. First, the data for this study was limited to 4 years two months, and forecasting it for 1 year ahead is the major factor influencing the performance. Suppliers' capacity and available storage capacity at the factory (plants) are also potential factors that influence the packaging material demand and are not recorded. Finally, the model forecasts are based on the history learned with a time frame of 52 weeks. Additionally, it will not be able to reflect very recent changes like the complete shutdown of the particular material type just learning from a few weeks before (Bachu and Kusetogullari, 2019).

## **CONCLUSION**

Selected models forecast considerable packaging demand for the next 52 weeks ( 1 Year). As a result, it can be stated that a reliable packaging demand can be forecasted using DNN on time series data. CNN model is observed to perform well, compared to LSTM. CNN is also a better model in terms of execution time. Considering the impact of data size, and the increase of data by the time of integrating it into the tool, CNN model is suggested.

## REFERENCES

- Anciros, G., Vilar, J. and Raña P. (2016), “Short-term forecast of daily curves of electricity demand and price,” *International Journal of Electrical Power & Energy Systems*, vol. 80, pp. 96–108, Sep. 2016. [Online]. Available: <http://www.sciencedirect.com/science/article/pii/S0142061516000466>
- Armstrong, J. S., (1985), *Long-range forecasting: from crystal ball to computer*, 2nd ed. New York: Wiley.
- Bacchetti, A., and Sacconi, N., (2012), “Spare parts classification and demand forecasting for stock control: Investigating the gap between research and practice,” *Omega*, vol. 40, no. 6, pp. 722–737, Dec. 2012. [Online]. Available: <http://www.sciencedirect.com/science/article/pii/S0305048311001484>
- Bachu, Y., Kusetogullari H., (2019), “Packaging demand forecasting in logistics using deep neural networks”. Master Thesis. Karlskrona: Blekinge Institute of Technology
- Bao, W., Yue, J. and Rao, Y., (2017), “A deep learning framework for financial time series using stacked autoencoders and long-short term memory,” *PLOS ONE*, vol. 12, no. 7, p. e0180944, Jul. 2017. [Online]. Available: <https://journals.plos.org/plosone/article?id=10.1371/journal.pone.0180944>
- Borovykh, A., Bohte, S. and Oosterlee, C. W., (2017), “Conditional Time Series Forecasting with Convolutional Neural Networks,” *arXiv:1703.04691 [stat]*, Mar. 2017, arXiv: 1703.04691. [Online]. Available: <http://arxiv.org/abs/1703.04691>
- Box, G. E., Jenkins, G. M., Reinsel, G. C., and Ljung, G. M., (2015), “*Time series analysis: forecasting and control*” John Wiley & Sons.
- Carbonneau, R., Laframboise, K., and Vahidov, R., (2008), “Application of machine learning techniques for supply chain demand forecasting,” *European Journal of Operational Research*, vol. 184, no. 3, pp. 1140–1154, Feb. 2008. [Online]. Available: <http://www.sciencedirect.com/science/article/pii/S0377221706012057>
- Chatfield, C., (2000), *Time-series forecasting*. Chapman and Hall/CRC.
- Connor, J. T., Martin, R. D. and Atlas, L. E., (1994), “Recurrent neural networks and robust time series prediction” *IEEE Transactions on Neural Networks*, vol. 5, no. 2, pp. 240–254, Mar. 1994.
- Gamboa, J. C. B., (2017), “Deep Learning for Time-Series Analysis,” *arXiv:1701.01887[cs]*, Jan. 2017, arXiv: 1701.01887. [Online]. Available: <http://arxiv.org/abs/1701.01887>
- Gilbert, K., (2005), “An ARIMA Supply Chain Model” *Management Science*, vol. 51, no. 2, pp.305–310, Feb. 2005. [Online]. Available: <https://pubsonline.informs.org/doi/abs/10.1287/mnsc.1040.0308>
- Granger, C. W. J. and Newbold, P., (2014), “*Forecasting Economic Time Series*” Academic Press, May 2014, google-Books-ID: oDWjBQAAQBAJ.



- Hugos, M. H., (2018), “*Essentials of Supply Chain Management*” John Wiley & Sons, Mar. 2018.
- Hyndman, R. J. and Fan, S., (2010) “Density Forecasting for Long-Term Peak Electricity Demand,” *IEEE Transactions on Power Systems*, vol. 25, no. 2, pp. 1142–1153, May 2010.
- Karabulut, M., Kusetogullari, H., & Kivrak, S. (2020). Outdoor performance assessment of new and old photovoltaic panel technologies using a designed multi-photovoltaic panel power measurement system. *International Journal of Photoenergy*, 2020.
- Papagiannaki, K., Taft N., Zhang, Z. and Diot C., (2003), “Long-term forecasting of Internet backbone traffic: observations and initial models,” in *IEEE INFO-COM 2003. Twenty-second Annual Joint Conference of the IEEE Computer and Communications Societies (IEEE Cat. No.03CH37428)*, vol. 2, Mar. 2003, pp. 1178–1188 vol.2.
- Pelletier, J. D. and Turcotte, D. L., (1997), “Long-range persistence in climatological and hydrological time series: analysis, modeling and application to drought hazard assessment,” *Journal of Hydrology*, vol. 203, no. 1, pp. 198–208, Dec. 1997. [Online]. Available: <http://www.sciencedirect.com/science/article/pii/S0022169497001029>
- Qiu, X., Zhang, L., Ren, Y., Suganthan, P. N. and Amaratunga, G., (2014), “Ensemble deep learning for regression and time series forecasting,” in *2014 IEEE Symposium on Computational Intelligence in Ensemble Learning (CIEL)*, Dec. 2014, pp. 1–6.
- Vineeth, VS., Kusetogullari H. and Boone A., (2020) “Forecasting Sales of Truck Components: A Machine Learning Approach,” 2020 IEEE 10th International Conference on Intelligent Systems (IS), 2020, pp. 510-516, doi: 10.1109/IS48319.2020.9200128.
- Volvo - Wikipedia. [Online]. Retrieved June 12, 2022 from <https://en.wikipedia.org/wiki/Volvo> (Retrieved: 12.6.2022)
- Volvo Group Packaging System | Volvo Group. [Online]. <https://www.volvogroup.com/en-en/suppliers/useful-links-and-documents/logistics-solutions/volvo-group-packaging-system.html> (Retrieved: 12.5.2019)
- Winters, P. R., (1960), “Forecasting sales by exponentially weighted moving averages” *Management science*, vol. 6, no. 3, pp. 324–342, 1960.
- Yang, X., Yu, F. and Pedrycz, W., (2017), “Long-term forecasting of time series based on linear fuzzy information granules and fuzzy inference system,” *International Journal of Approximate Reasoning*, vol. 81, pp. 1–27, Feb. 2017. [Online]. Available: <http://www.sciencedirect.com/science/article/pii/S0888613X16302080>



  
**CHAPTER 15**

**ANALYSIS OF THE FACTORS INFLUENCING  
THE POINT TO POINT (P2P) CONNECTION  
IN THE 5G MOBILE NETWORK**

*Teodor Iliev<sup>1</sup>*

*Ivaylo Stoyanov<sup>2</sup>*

*Grigor Mihaylov<sup>3</sup>*

---

1 University of Ruse, Department of Telecommunications, Ruse, Bulgaria

2 University of Ruse, Department of Electric Power Engineering, Ruse, Bulgaria

3 University of Telecommunications and Post, Department of Telecommunications,  
Sofia, Bulgaria

\*Corresponding author: [tiliev@uni-ruse.bg](mailto:tiliev@uni-ruse.bg)

## **1. INTRODUCTION**

All spheres of social and economic life today is growing at a tremendous rate on a daily basis. Telecommunication networks, through which information is exchanged around the world, have made a huge contribution to the development of information and communication technologies in the 21st century. On the other hand, the development of technologies requires constant development and improvement in the field of telecommunications (Iliev, 2021).

One of the main components of modern telecommunications networks are the so-called cellular telecommunications networks. The need for these networks arises from the growth of international business, interconnected international communication channels, the introduction of IoT systems and systems operating with different communication standards requiring constant connection with each other, at anytime and anywhere. The latest fifth generation for wireless communications - 5G, provides high data rates and low latency (eliminating time delays in the exchange of large packets of information), wide bandwidth, etc (Tsigkanos, 2019).

5th generation communication systems aim to achieve high spectral and energy efficiency, low latency and massive connectivity due to the large growth in the number of Internet of Things (IoT) devices.

These IoT devices enable advanced services such as intelligent traffic, environmental monitoring and control, virtual reality (VR) / virtual navigation, telemedicine, digital detection, high resolution (HD) and full HD video transmission in connected drones and robots (Iliev, 2021; Ma, 2015).

Broadcast is a technology for distributing the same content to an unlimited number of users or devices in the coverage area with a certain quality of service, without the need to increase the requirements for network capacity. Broadcasting is considered by many researchers to be an essential part of the 5G network. Point-to-point connection is a key component in core networks and 5G radio access networks (Ivanova, 2021; Saily, 2019).

In this regard, developing a secure and reliable free-space transmission or so call point-to-point communication will enable the fulfillment of the set goals by the 5G networks.

## **2. TRANSMISSION MEDIA IN MOBILE NETWORK**

### **2.1. Main characteristics of transmission in mobile networks**

The mobile networks can be divided into three main subnets: access network, transmission network and mobile device/station. They are all

connected in a hierarchical structure with core network, which performs switching processes (Farag, 1995; Pinheiro, 2007). Transmission network (relay and optical connections in the network) has the task of providing a connection to access network (all base station in the network) with the core network. On the other hand the access network provides services to users.

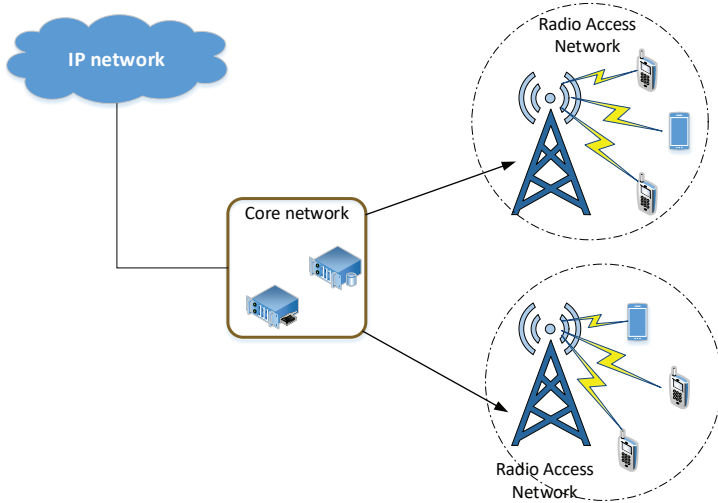


Figure 1. Hierarchy model of the mobile network

On Fig. 2 are shown the main methods for communication between the base station (BS) and core network, established with optical links and microwave lines (Olsson, 2010).

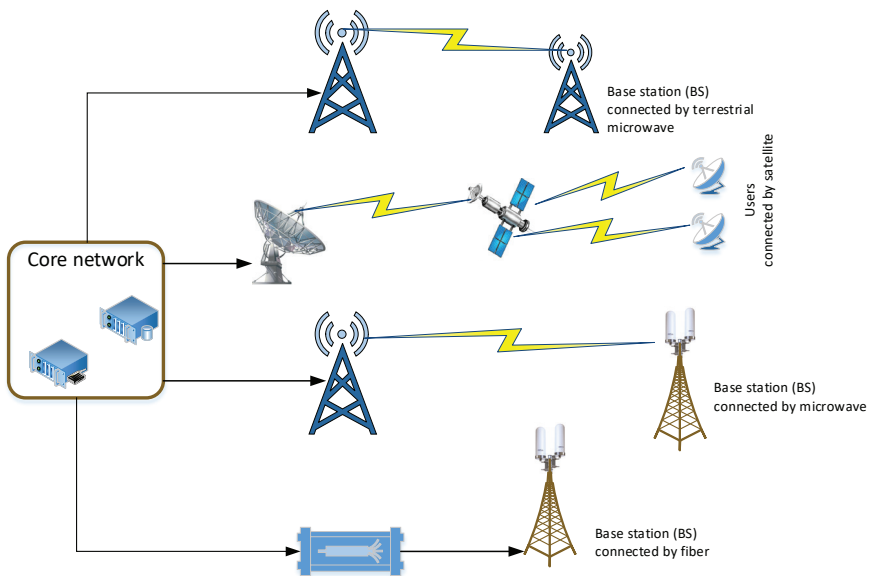


Figure 2. Network topology

Microwave lines are also used in the case when developing a connection to the end user, as already mentioned cheap and fast option for implementation (ETSI, 2018).

## **2.2. Advantages of microwave technology**

The benefits of optical transmission in mobile communication networks are undeniable. However, in many cases, when the access network is a part of the networks located outside the cities, we should note that this type of transmission is not particularly applicable. The high costs of construction of such line combined with potential interventions concerning the settlement infrastructure and the necessary documents for this purpose suggest a low probability of designing cable lines to a large part of the sites. According to these shortcomings of optical transmission, we can assume that microwave transmission will continue to be the main alternative and the technologies and devices associated with it will continue to evolve dynamically to meet the needs of high speed and stable connectivity. For this reason, in certain cases, the first microwave transmission is built to a site, which provides traffic until the construction and commissioning of optical connectivity. The relay equipment released from traffic is then moved to another site. Similar scenarios demonstrate the great flexibility of radio transmission over optical fibers. Radio transmission requires a shorter recovery time in the event of an emergency, so radio relay lines are often used as a backup for optical connections. Another advantage of microwave transmission in relation to the restoration of disconnected connections is the possibility of recovery by changing the location and use of temporary structures when there is a change in infrastructure due to demolition or construction of a new building obstructing direct line of sight (Boric-Lubecke, 2015).

The evolution of information and communication technologies allows radio systems to operate at the same errors as optical fibers (usually BER is approximately  $10^{-13}$ ). Radio transmission also has its drawbacks, such as the need of direct line of sight in most frequency bands, which grows into a limited, from an infrastructural point of view, number of locations for constructing such connections.

## **3. PLANNING THE MICROWAVE LINKS**

The biggest challenge in designing a radio link is to achieve the predicted level of quality, under all conditions, for a sufficiently long period of time. One of the key advantages of construction of a microwave radio link is that the connections can be designed to meet very specific quality standards according to the type and importance of the transmitted traffic (Sseyiga, 2014). The implementation of adaptive modulation in radio communications, different services can work with different levels of quality of service (QoS). It should be noted that the reliability of the connection is

influenced by the topology of the link and the equipment protection level. This is complicated when viewed in the context of radio data networks with higher layer protocols such as transmission control protocol/Internet protocol (TCP/IP) or multiprotocol label switching (MPLS).

### 3.1. Transmission reliability standards

According to ITU standards, reliability is crucial for radio communication. (Manning, 2009) determined that the period of incapacity begins when in at least one of the directions of transmission at least one of the listed conditions occurs for a period of 10 consecutive seconds: interruption of the digital signal or BER in each second is worse than  $1 \times 10^{-3}$ . In most common cases, long breaks are caused by specific reasons and can be summarized in the following three categories

- Broadcasting
- Equipment damage or fail
- Other factors

On the other hand, disruptions related to broadcasting are mainly due to the following three reasons:

**Refraction** - a condition that may occur if the propagation of the radio signal exceeds the curvature of the earth. Losses from this phenomenon can be limited if there is a system of the type „Space diversity”. Such a system consists of additional antennas at the transmitter and receiver side used to reduce the effect of refraction.

**Diffraction losses** - due to diffraction of the radio signal caused by the deviation of the waves from their rectilinear propagation. Usually this condition is due to the propagation of the radio signal propagating too close to the earth's surface and this causes signal loss (ITU-R, 2019).

**Bad weather conditions** - transmission interruptions caused by heavy rainfall. Water molecules absorb the electromagnetic waves. The larger the water droplets, the greater the amount of signal absorption. In case of snowfall, it is desirable to ensure that the snow cover or the resulting icing will not stay on the antennas for a long time, so anti-freeze systems are applied in certain places.

In the event of damage to the communication modules, long interruptions may occur. The number of times the radio/communication equipment fails is inversely proportional to the mean time before failure (MTBF). The duration of the outage is determined by the time required by the maintenance team to restore the service or the mean time to recovery (MTTR). This value includes the travel time, the actual time to repair the fault and the availability of the necessary spare parts. The availability of a

device can be calculated according to:

$$A = (MTBF / (MTBF + MTTR)) \times 100\% \tag{1}$$

Other factors include any events such as planned maintenance outages or major unforeseeable accidents, such as fires, floods and other natural disasters and large-scale accidents. A common solution to such problems is to ensure redundancy (an alternative route to ensure microwave transmission). When radio network planning, it is important to consider all the characteristics of the equipment that affect its overall performance. There are other requirements that affect the design of any radio network. Such a requirement is the transmission of Ethernet over radio transmission (ITU-R, 2008). Another function that has been established in recent years is the so-called adaptive coding and modulation (ACM).

#### 4. SIGNAL INTERFERENCES

##### 4.1. Climatic influences caused by the rain

The effect of precipitation and especially rain on radio waves can be of great importance depending on the bandwidth and intensity of precipitation. A scattering concept will be applied to diffuse scattering when radio waves interact with raindrops, resulting in attenuation (ITU-R, 2005).

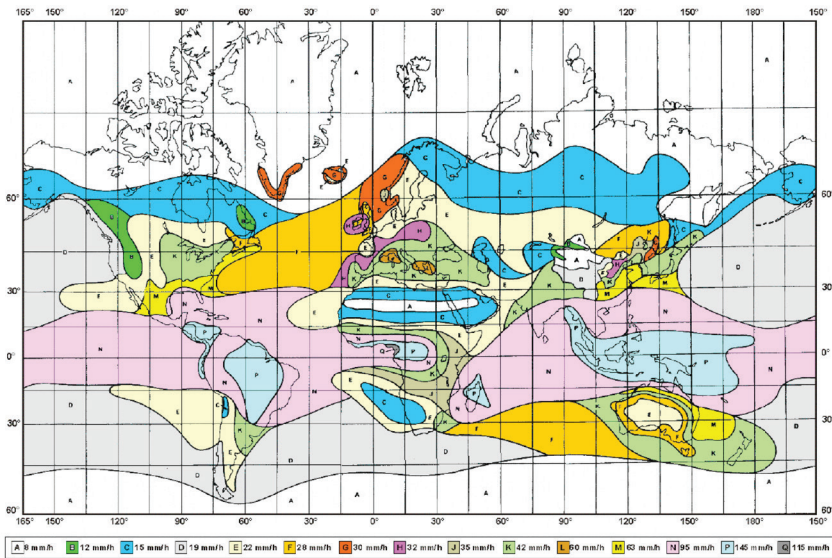


Figure 3. Map of the distribution of rainfall

The scattering and absorption of radio waves by raindrops cause attenuation. Although all frequencies are subject to these effects, rain attenuation is only practical for frequencies above 10 GHz.



Specific attenuation can be obtained from diagrams presenting the interdependence of specific attenuation in dB / km and frequency in GHz.

The effect of polarization can be largely ignored. However, at high rain speeds (30 mm/h) and high frequencies (20 GHz) horizontal polarization can give a specific attenuation 0.5 dB/km higher than vertical polarization. Dependence on rain attenuation can be assessed by introducing a reduction factor that takes into account the degree of rain clouds in the radio path and then determining the effective road length by multiplying the actual road length by the reduction factor.

It should be noted that the speed of rain is a parameter that is very dependent on the geographical location of the radio network. It should be obtained from a cumulative distribution of long-term measurements. For network planning purposes, the world is divided into 16 different rain zones (Trenberth, 2018) for which instantaneous rain velocity values can be obtained (Figure 3) (Hilt, 2019). From Figure 3 is evident that the countries of Central and Eastern Europe fall mainly in the areas with rainfall of 25 mm / h, 32 mm / h and 42 mm / h, called E, H and K zones. In the planning phase, the precipitation rate often approaches a single value for medium and small countries, i.e. 42 mm / h for the whole territory of Bulgaria.

#### **4.2. Fading**

Several influences can lead to signal losses, even when the transmitter and receiver sides in line of sight (LoS). If LoS is close to an Earth's surface with large obstacles or hills, the loss of obstacles may become important, although the line of sight is not closed. In the presence of any changes in the Earth's radius factor due to refraction, the path of the radio signal may be subject to diffraction or refraction. Propagation conditions, such as atmospheric changes and reflections due to land / water, can cause variations in the received signal or fading (Magne, 1994).

In the condition when the line of sight is high above the Earth's surface, diffraction losses can be avoided, but the following will occur: flat fading, frequency-selective fading, precipitation losses, refraction-diffraction (k-type losses) due to interference between the direct component of the field of the signal and components reflected from the Earth's surface, from layers of the atmosphere and from buildings.

The fading margin is a project allowance that provides sufficient resources to meet the expected losses. Thus, the required quality of service (QoS) of the network is guaranteed (Gatsis, 2010).

## 5. METHODS FOR OVERCOMING THE ADVERSE EFFECTS OF NETWORK QUALITY DETERIORATING

### 5.1. Adaptive transmit power control

The adaptive transmit power control (ATPC) is a feedback control system that temporarily increases the transmitter output power during periods of fade degradation, thus eliminating (or at least reducing) the adverse effects of degraded route parameters. Hence ATPC offers immediate and long-term benefits to the network operator, including reduced average power consumption, extended MTBF equipment and lower long-term RF interference levels (Sseyiga, 2014).

$$\text{Fade Margin} = \text{Fixed Margin} + \text{Dynamic Range} \quad (2)$$

Hop ATPC is shown on Figure 4.

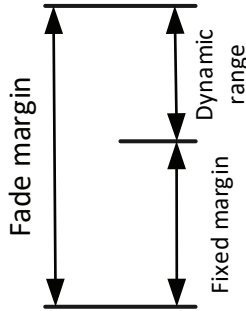


Figure 4. Relation between fade margin, fixed margin and dynamic range

The ATPC algorithm can be implemented in various ways, among which are hop-ATPC and node-ATPC. In hop ATPC the power is adjusted individually for each connection. In this case, each connection based on the distribution conditions will decide which power level to use depending only on the distribution conditions. Thus, during bad weather condition, the connection will increase the power level to compensate the fading. However, the extra power used can cause serious interference to other connections in the network (Callaghan, 2006; Chiang, 2008).

Assuming that the base stations (BS) in the central node are coordinated, it is possible to mitigate excessive interference by increasing the output power levels of unfaded connections in accordance with the faded connection. In this way, the SINR to external BS will be maintained as fading and interference will be successfully compensated, the mentioned technique is known as node-ATPC.

The output power  $P_{out}$  can be controlled in fixed or adaptive mode. In fixed mode, the output power  $P_{out}$  varies from the minimum level  $P_{fix}$

$P_{min}$  to the maximum level  $P_{max}$ . The  $P_{set}$  value is set manually in 1dB steps, locally or remotely from the control system.

In adaptive mode, the ATPC function is used to automatically control the output power  $P_{out}$ . As a result, the power is continuously adjusted so as to maintain a minimum input level set by the far end terminal. Under normal conditions, ATPC maintains the output power at a reduced level, which leads to a lower level of interference in the radio network (Chiang, 2008, Ericsson).

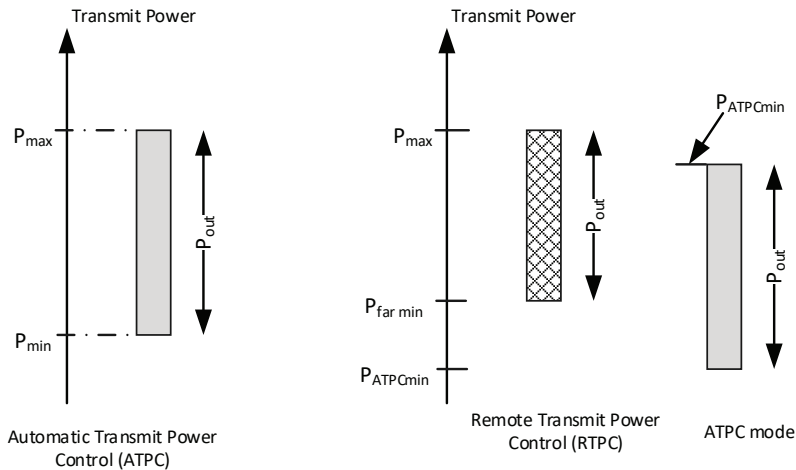
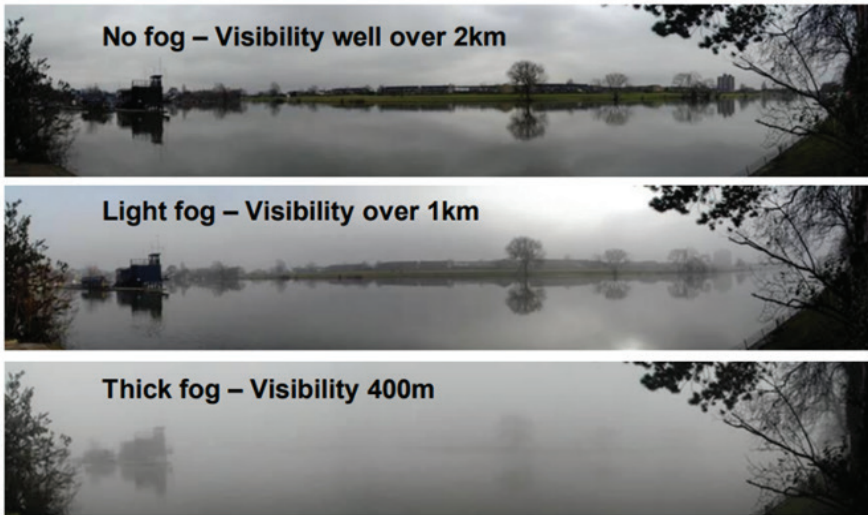


Figure 5. Transmission power control

In adaptive mode, the ATPC function is used to automatically control the output power  $P_{out}$ . As a result, the power is continuously regulated so as to maintain a minimum input level set by the end terminal. Under normal conditions of the link, ATPC maintains the output power at a reduced level, which leads to a lower level of interference in the radio network.

Fog over a river can be given as an example of bad weather conditions (ITU-R, 2021). ATPC significantly increases power and maintains the network connection. Figure 6 shows visibility in dense fog (400 meters), in fog (over 1 km) and in clear weather (over 2 km) (Malik, 2015).



*Figure 6. Fog over a river*

For long distance radio links, the adaptive coding and modulation function allows the radio relay connection to dynamically adjust the modulation in heavy rain conditions to ensure maximum connection operation time, capacity and range (Singh, 2022). For short distance radio links and long connections in low rainfall regions, the connections retain 10Gbps at all times.

## **5.2. Cross polarization**

Electromagnetic waves propagate in 3D space in a straight line with orthogonal and oscillating electric and magnetic fields. The condition is that the fields should be orthogonal to each other, as well as the direction of propagation. In this way, a plane that is perpendicular to the direction of propagation will contain the all electromagnetic fields. For a given wave, one of the field components (magnetic or electrical) may oscillate, for example along the vertical axis, which requires the other field component to oscillate along the horizontal axis.

Most of the waves used in radio relay links propagate on the earth's surface, i.e. vertically or horizontally polarized waves, which means that the electric field oscillates in the vertical or horizontal direction, respectively.

The radio wave can be polarized in any direction, but more importantly, each polarization can be divided into the two components that form the orthogonal base. The dipole antenna is a good example of a polarized antenna, as it transmit and receive only one polarization ideally. The presence of two ideal polarized antennas rotated so that they

are orthogonal to each other results in two independent channels doubling the capacity of the high SNR system. In a real system, there are always imperfections leading to cross-references between polarizations (Figure 7). This is due to the fact that the antennas cannot be perfectly polarized and in some circumstances, the channels may treat the polarizations differently (eg rain), leading to losses between channels.

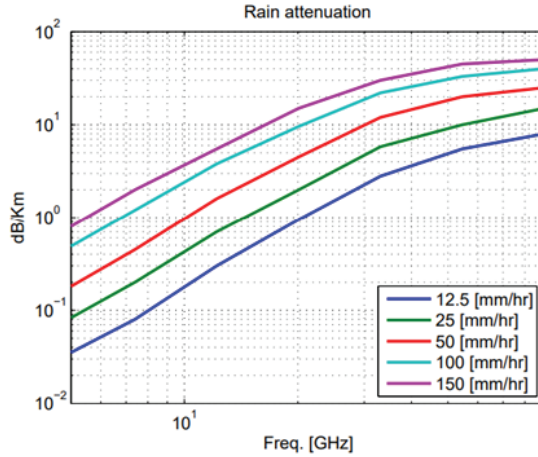


Figure 7. Signal attenuation caused by rain at different frequencies for horizontally polarized signals

These losses can be calculated using the channel cross-polarization discrimination (XPD) (ITU-R, 2008). It describes how much power from one polarization is lost compared to another polarization, thus reducing the separation of system capabilities to split between the two polarizations. It can be defined for vertical and horizontal components respectively as:

$$XPD_V = \frac{E\{ |h_{V,V}|^2 \}}{E\{ |h_{H,V}|^2 \}} \quad XPD_H = \frac{E\{ |h_{H,H}|^2 \}}{E\{ |h_{V,H}|^2 \}} \quad (3)$$

where  $h_{V,H}$  is the impulse response of the flat channel between the vertically polarized Tx horizontally polarized Rx. In this case, the two XPDs are combined into one, assuming that they are the same for both polarizations -  $XPD = XPD_V = XPD_H$ .

The cross-polarization interference canceller (XPIC) is a technology that allows simultaneous transmission of vertical polarization and horizontal polarization of a frequency pair. The XPIC system filters cross-polarization interference in order to successfully receive or decode the

desired signal. In this way, the network capacity will be effectively doubled for a given frequency band. The improvement achieved by using XPIC is usually around 20-25 dB.

When designing a XPIC must be taken into account the followings:

- Ultra-high performance, double polarized antennas should be used. Double polarized antennas have two irradiators that transmit in vertical and horizontal polarization.
- The use of ultra-high performance antennas leads to mitigate the cross-channel interference.
- Preferably, the ATPC operates in both polarizations of the XPIC link.

Cross-polar discrimination (XPD) is one of the important characteristic of the microwave antennas. In *Tx* mode, XPD is the ratio between the transmitted signal in the orthogonal polarization to the required one. In *Rx* mode, XPD is the antenna's ability to preserve the event signal's polarization purity. First we should calculate the  $XPD_0$ :

$$XPD_0 = \begin{cases} XPDg^{-5} & \text{for } HPDg \leq 35 \\ 40 & \text{for } HPDg > 35 \end{cases} \quad (4)$$

where  $XPDg$  is the manufacturer-guaranteed minimum XPD in the open position of both the transmitter and the receiving antenna.

After that we should calculate the multipath activity factor,  $\eta$ :

$$\eta = 1 - e^{-0,2(R)^{0,5}} \quad (5)$$

For a transmitting antenna  $Q$  can be calculated as:

$$Q = -10 \log \left( \frac{0,7\eta}{R} \right) \quad (6)$$

$R$  is multipath fade occurrence factor, which can be calculated as  $P0/100$ , corresponding to the percentage of time  $P0$  (%) exceeding  $A = 0$  dB on average the worst month.

The multipath fade occurrence factor calculated using the basic interrupt equation influenced by atmospheric conditions.

$$R = 2,5 \times 10^{-6} cfd^3 \quad (7)$$

where C is equal to:

$$C = XPD_0 + Q \quad (8)$$

The total interference of losses and disturbances with and without XPIC is calculated with the following equation (Bohagen, 2006):

$$IFM = \begin{cases} C - C_0/I & \text{without XPIC} \\ C - C_0/I + XPIC & \text{with XPIC} \end{cases} \quad (9)$$

## 5. CONCLUSION

The technological world nowadays develops on a daily basis with unprecedented trends. A great contribution to the technological boom of the 21st century is the telecommunications networks through which information exchange takes place around the world. The daily development of technology requires constant development and improvement in the field of telecommunications. Radio relay connectivity has been a major method of transmission in the past, and to date they play the role of an alternative one to optical networks. However, the need to achieve high speeds for the transmission of a large data volume inevitably necessitates the development of new trends in this field, such as reducing apparatus gauges, increasing reliability, increasing capacity and using higher frequency ranges. Fifth generation mobile networks are the next step forward. Users of these mobile communications networks are increasingly demanding of data transmission speed, quality of service and so on. This requires the constant improvement of the provided services. The 5G network aims to deliver up to one million connections per square kilometre. This is essential when it comes to creating Smart Cities, as millions of small, low-power devices, from traffic lights to mobile devices, will be able to connect.

## ACKNOWLEDGEMENT

This work is also partially supported by the EC Project 2020-1-PL01-KA226-HE-096196, project title: "Holistic approach towards problem-based ICT education based on international cooperation in pandemic conditions".

## REFERENCES

- Bohagen, F., Orten, P. & Oien, G. E., (2006). Optimal Design of Uniform Planar Antenna Arrays for Strong Line-of-Sight MIMO Channels. *IEEE 7th Workshop on Signal Processing Advances in Wireless Communications*, pp. 1-5, doi: 10.1109/SPAWC.2006.346341.
- Boric-Lubecke, O., Lubecke, V. M., Jokanovic, B., Singh A., Shahhaidar, E. & Padasdao, B. (2015). Microwave and wearable technologies for 5G. *12th International Conference on Telecommunication in Modern Satellite, Cable and Broadcasting Services (TELSIKS)*, pp. 183-188, doi: 10.1109/TELSIKS.2015.7357765.
- Callaghan, S.A., Inglis, I. & Hansell P. (2006). Spectrum efficiency gains resulting from the implementation of adaptive transmit power control in fixed terrestrial links at 38 GHz. *First European Conference on Antennas and Propagation*, pp. 1-6, doi: 10.1109/EUCAP.2006.4584808.
- Chiang, M., Hande, P., Lan, T. & C. W. Tan (2008). Power Control in Wireless Cellular Networks, In A. Ephremides (Ed.), *Foundations and Trends in Networking sample*, Publishers Inc.
- Ericsson, Retrieved from <https://www.ericsson.com/en/reports-and-papers/ericsson-technology-review/articles/microwave-backhaul-gets-a-boost-with-multiband>
- ETSI White Paper No. 25 (2018) Microwave and Millimetre wave for 5G Transport, Retrieved from [https://www.etsi.org/images/files/ETSIWhitePapers/etsi\\_wp25\\_mwt\\_and\\_5g\\_FINAL.pdf](https://www.etsi.org/images/files/ETSIWhitePapers/etsi_wp25_mwt_and_5g_FINAL.pdf)
- Farag, E., Saleh, M., Elnady, N. & Elmasry M., (1995). Structure and network control of a hierarchical mobile network architecture. *Proceedings International Phoenix Conference on Computers and Communications*, 671-677, doi: 10.1109/PCCC.1995.472421.
- Gatsis N., Marques, A. G. & Giannakis, G. B., (2010). Power control for cooperative dynamic spectrum access networks with diverse QoS constraints. *IEEE Transactions on Communications*, 58(3), pp. 933-944, doi: 10.1109/TCOMM.2010.03.080491.
- Hilt, A. (2019). Availability and Fade Margin Calculations for 5G Microwave and Millimeter-Wave Anyhaul Links. *Appl. Sci.* 2019, 9, 5240. <https://doi.org/10.3390/app9235240>
- Iliev, T. B., Ivanova, E.P., Stoyanov, I.S., & Mihaylov, G. Y. (2021). Evolution of 5G networks towards the future 6G mobile networks: concepts, services and key trends. In B. Hasdemir, M. Turhan & C. Karaman (Eds.), *Research & Reviews in Engineering* (pp. 1-22). Ankara, Gece Publishing.
- ITU-R (2008). Handbook. Radiowave propagation information for designing terrestrial point-to-points links, Retrieved from [https://www.itu.int/dms\\_pub/itu-r/opb/hdb/R-HDB-54-2009-OAS-PDF-E.pdf](https://www.itu.int/dms_pub/itu-r/opb/hdb/R-HDB-54-2009-OAS-PDF-E.pdf)



- ITU-R Handbook (2008). Radiowave propagation information for designing terrestrial point-to-point links, Retrieved from <http://handle.itu.int/11.1002/pub/80301443-en>
- ITU-R P.526-15 (2019). Propagation by diffraction, Retrieved from [https://www.itu.int/dms\\_pubrec/itu-r/rec/p/R-REC-P.526-15-201910-I!!PDF-E.pdf](https://www.itu.int/dms_pubrec/itu-r/rec/p/R-REC-P.526-15-201910-I!!PDF-E.pdf)
- ITU-R P.838-3 (2005). Specific attenuation model for rain for use in prediction methods, Retrieved from [https://www.itu.int/dms\\_pubrec/itu-r/rec/p/R-REC-P.838-3-200503-I!!PDF-E.pdf](https://www.itu.int/dms_pubrec/itu-r/rec/p/R-REC-P.838-3-200503-I!!PDF-E.pdf)
- ITU-R P.840-5 (2021). Attenuation due to clouds and fog, Retrieved from [https://www.itu.int/dms\\_pubrec/itu-r/rec/p/R-REC-P.840-5-201202-S!!PDF-E.pdf](https://www.itu.int/dms_pubrec/itu-r/rec/p/R-REC-P.840-5-201202-S!!PDF-E.pdf)
- Ivanova, E., Iliev, T., Stoyanov, I., & Mihaylov, G., (2021) Evolution of mobile networks and seamless transition to 5G. *IOP Conference Series: Materials Science and Engineering*, 1032, 012008, <https://doi.org/10.1088/1757-899X/1032/1/012008>
- Ma, Z., Zhang, Z., Ding, Z. et al. (2015). Key techniques for 5G wireless communications: network architecture, physical layer, and MAC layer perspectives. *Sci. China Inf. Sci.* 58, 1–20 <https://doi.org/10.1007/s11432-015-5293-y>
- Magne P., Iltis J., Brémenson C., Legendre P. (1994). Point-to-point transmissions, terrestrial line-of-sight links, terrestrial troposcatter links. In: Smith B.L., Carpentier MH. (Eds.) *The Microwave Engineering Handbook. Microwave Technology Series*, vol 3. Springer, Boston, MA. [https://doi.org/10.1007/978-1-4615-2506-6\\_1](https://doi.org/10.1007/978-1-4615-2506-6_1)
- Malik, A., Singh P., (2015). Free Space Optics: Current Applications and Future Challenges, *International Journal of Optics*, 945483, <https://doi.org/10.1155/2015/945483>
- Manning T. (2009). *Microwave Radio Transmission Design Guide*, 2<sup>nd</sup> ed., Artech House
- Olsson, M., Sultana, S., Rommer, S., Frid, L. & Mulligan, C., (2010). Chapter 3 - Architecture overview. In M. Olsson, S. Sultana, S. Rommer, L. Frid & C. Mulligan (Eds.), *SAE and the Evolved Packet Core* (po. 23-69), Academic Press,
- Pinheiro P.R. & Aguiar A. B. (2007). A Model for GSM Mobile Network Design. In: Sobh T., Elleithy K., Mahmood A., Karim M. (Eds.) *Innovative Algorithms and Techniques in Automation, Industrial Electronics and Telecommunications*. Springer, Dordrecht. [https://doi.org/10.1007/978-1-4020-6266-7\\_65](https://doi.org/10.1007/978-1-4020-6266-7_65)
- Saily, M., Barjau, C., Navrátil, D., Prasad, A., Gómez-Barquero D. & Tesema, F. B. (2019). 5G Radio Access Networks: Enabling Efficient Point-to-Multipoint Transmissions, *IEEE Vehicular Technology Magazine*, 14(4), 29-37, Dec. 2019, doi: 10.1109/MVT.2019.2936657.
- Singh, H., Kumar, V., Saxena, K. et al. (2022). A Smart Model for Prediction of Radio Wave Attenuation Due to Clouds and Fog (SMRWACF). *Wireless Pers Commun* 122, 3227–3245, <https://doi.org/10.1007/s11277-021-09047-1>

- Sseyiga, H. (2014). A Planner's Guide to Terrestrial Microwave Link Planning, Retrieved from [https://www.academia.edu/32061296/A\\_Planners\\_Guide\\_to\\_Terrestrial\\_Microwave\\_Link\\_Planning](https://www.academia.edu/32061296/A_Planners_Guide_to_Terrestrial_Microwave_Link_Planning)
- Trenberth, K. E. & Zhang, Y. (2018). How Often Does It Really Rain?, *Bulletin of the American Meteorological Society*, 99(2), pp. 289–298, <https://doi.org/10.1175/BAMS-D-17-0107.1>
- Tsigkanos, C., Nastic, S., & Dustdar, S. (2019). Towards resilient Internet of Things: Vision, challenges, and research roadmap. *IEEE 39th International Conference on Distributed Computing Systems, ICDCS*, Dallas, TX, USA. pp. 1754–1764, doi: 10.1109/ICDCS.2019.00174.